1x Software Manual

Release 8.2/1.0

Embention Sistemas Inteligentes, S.A.

2026-04-27

Contents

Scope of Changes	6
Software Applications	7
Veronte Link	7
1x PDI Builder.....	7
Veronte Ops.....	7
Veronte HIL.....	8
Veronte Updater	8
1x PDI Calibration.....	9
Veronte FDR	9
Veronte VSA	9
1x PDI Tuning	9
Nomenclature	10
Reference Directions	10
Axes	12
Core architecture.....	13
Task distribution	13
Monitoring variables.....	15
Data Transmission	19
Lists of interest.....	21
Activation System Error bits.....	21
Status Message variables.....	22
Extended Status Message variables.....	23
List of Addresses	26
Lists of Variables	30
BIT Variables	31
Real Variables (RVar) - 32 Bits.....	76
Integer Variables (UVar) - 16 Bits	183
Features Variables - 64 Bits.....	223
Navigation Variables	235
List of PDI Errors.....	240
List of File System Errors	271
Firmware Changelog	273
8.2	273

Step by step	274
VTOL	275
Aircraft specifications.....	276
1x Air configuration	279
1x PDI Builder configuration	280
Name & Attitude.....	284
Unit name	284
Attitude	285
Actuators & SU Matrix	286
GPIO to PWM connection.....	286
Actuators.....	287
SU Matrix	293
Modes & Phases	298
Modes definition.....	298
Phases definition.....	300
Block Programs	301
Navigation.....	303
Guidance.....	313
Stick.....	338
Control Mix.....	339
Pitching	342
Rolling	347
Yawing.....	355
Thrust (Vertical)	358
Throttle (Horizontal).....	362
Euler to Body Axis.....	366
Rates to control.....	368
Control to servo	375
RPM XPlane	379
Compute RTH	379
RTH distance OK	383
Automations	384
Calibration	385
Home	386
Navigation.....	386

Integral Enable.....	387
Failsafe.....	387
Stick.....	388
Transitions.....	389
Phase Buttons.....	391
Transitions table.....	392
Sensors.....	393
Accelerometer.....	394
Gyroscope.....	397
Magnetometer.....	401
Dynamic Pressure.....	401
Static Pressure.....	402
HIL Configuration.....	403
Checklist.....	406
Operation.....	407
Operation 1.....	410
Mission.....	410
Start Route.....	414
Runway.....	415
Home Point.....	417
Operation 2.....	418
Area 1.....	418
Area 2.....	422
Operation 3.....	422
Missions.....	423
Mark A.....	423
Mark B.....	427
Workspace.....	430
Map.....	431
Main.....	431
Displays.....	433
Charts.....	435
Flight instruments.....	437
Simulation.....	438
Operation 1.....	439

Initial and Standby	440
Armed.....	440
Take-off.....	441
Hover.....	441
Cruise	442
Loiter	443
Hold.....	444
Approach	445
Landing	446
Return to Home	447
Operation 2.....	448
Area 2.....	449
Area 1.....	450
Operation 3.....	450
Mark A to Mission 2	451
Mark B to Approach phase	452
Stick.....	452
1x GCS configuration	455
Air-GCS connection	459
Communication	459
GND unit configuration.....	460
Air unit configuration.....	460
GND-Air communication configuration	461
GND-Air data transmission configuration	462
Radio pairing	464
Stick.....	465
Ground unit	466
Air unit	468

Scope of Changes

- Version 1.0
 - Added:
 - First version issued

Software Applications

Veronte Link

Veronte Link establishes communication between a computer and any Veronte product by creating a VCP bridge.

It allows multiple control stations and autopilots to be interconnected, operating simultaneously.

Veronte Link also includes a post-flight viewer to reproduce all recorded data from previous flights and generate plots and reports.

For more information, visit the [Veronte Link user manual](#).

1x PDI Builder

1x PDI Builder is the main configuration tool to adapt a **Veronte Autopilot 1x** to a specific vehicle, including user-defined communication protocols.

1x PDI Builder includes:

- **Telemetry:** Real-time onboard UAV metrics, such as sensors, actuators, and control states.
- **Configuration:** Edit vehicle settings, such as servo trim, interface/port management, and modes.
- **Automations:** Actions that are automatically executed when a set of configured conditions is met.
- **Block Programs:** **Veronte Autopilot 1x** can be programmed with a user-friendly programming language.

For more information, visit the [1x PDI Builder user manual](#).

Veronte Ops

Veronte Ops is the application used to operate and monitor the vehicle during missions.

To know more, read the [Veronte Ops user manual](#).

Veronte Terrain Provider estimates and displays the terrain height and the aircraft height.

When working in conjunction with the Veronte Ops application, it helps to avoid collisions.

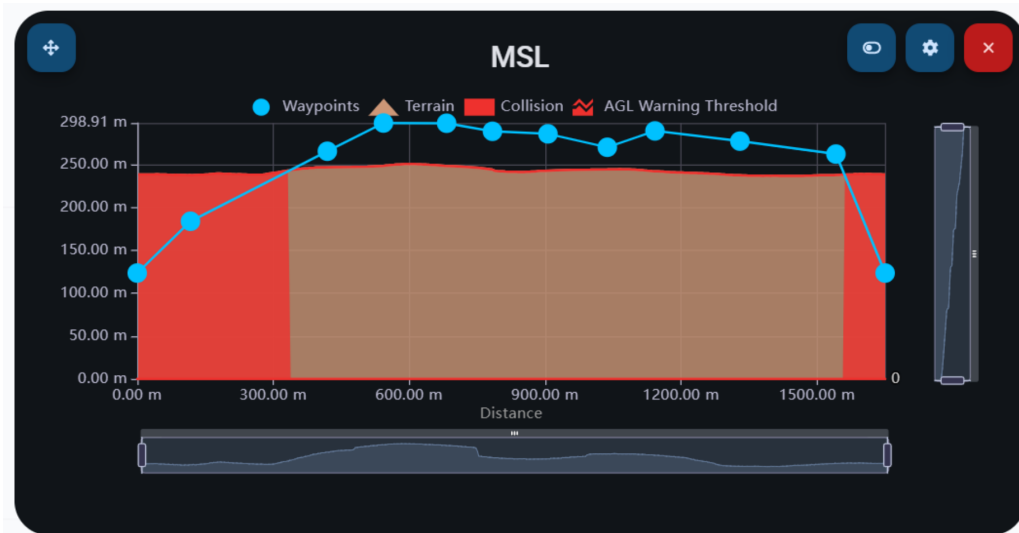

Heights example from Veronte Ops widget

For more information about **Veronte Terrain Provider**, read the [Veronte Terrain Provider - Additional apps](#) section of the **Veronte Ops** user manual.

Veronte HIL

Veronte HIL (Hardware In the Loop) is a simulation package for autopilot integration, development, and operator training.

This software allows extensive operation of the flight system in a simulated environment before executing real flight operations.

Its role is to perform HIL simulations with the real autopilot hardware, allowing the use of simulation applications like **X-Plane**, **Microsoft Flight Simulator**, or **Simulink**.

For more information, visit the [Veronte HIL user manual](#).

Veronte Updater

Veronte Updater updates all Embention products.

For more information, visit the [Veronte Updater user manual](#).

1x PDI Calibration

1x PDI Calibration sets up calibration parameters for 1x autopilots. It allows the user to calibrate sensors, servos, and configure the radio module.

For more information, visit the [1x PDI Calibration user manual](#).

Veronte FDR

Veronte FDR manages autopilot files, allowing users to download registers generated by the autopilot and convert them to CSV files.

Three types of registers can be downloaded: **Onboard log**, **Fast log**, and **User log**.

For more information, visit the [Veronte FDR user manual](#).

Veronte VSA

Veronte VSA works using a flight simulator to represent worldwide geographical scenarios: lands, seas, mountains, cities, airports, airfields, heliports...

Additionally, an internet connection is not necessary, allowing operation from any location without delays in scenario loading.

Veronte VSA displays a 3D view of the piloted aircraft and can be used as a **3D PFD (Primary Flight Display)** when using the first-person camera view. This system allows custom aircraft models to be displayed in the virtual environment. The **Planemaker** tool is available for creating custom models, enabling operators to visualize aircraft models in the interface.

For more information, visit the [Veronte VSA user manual](#).

1x PDI Tuning

1x PDI Tuning allows managing the **control laws** of the **Autopilot 1x** during operation.

Users can adjust each **P (Proportional)**, **I (Integral)**, and **D (Derivative)** gain and select the **PID type** (Standard or Parallel).

For more information, visit the [1x PDI Tuning user manual](#).

Nomenclature

This section defines the nomenclature convention employed by the software applications.

Reference Directions

- **Yaw** is the direction where the aircraft is pointing. It does not depend on the movement, as **Yaw** is aligned with the longitudinal axis of the aircraft.
- **Heading** is the movement direction projected to the ground. **Heading** does not depend on wind or **Yaw** direction; it only depends on the ground and the aircraft's movement.

Important

Both **Yaw** and **Heading** angles are measured concerning the **True North**, not the **Magnetic North**.

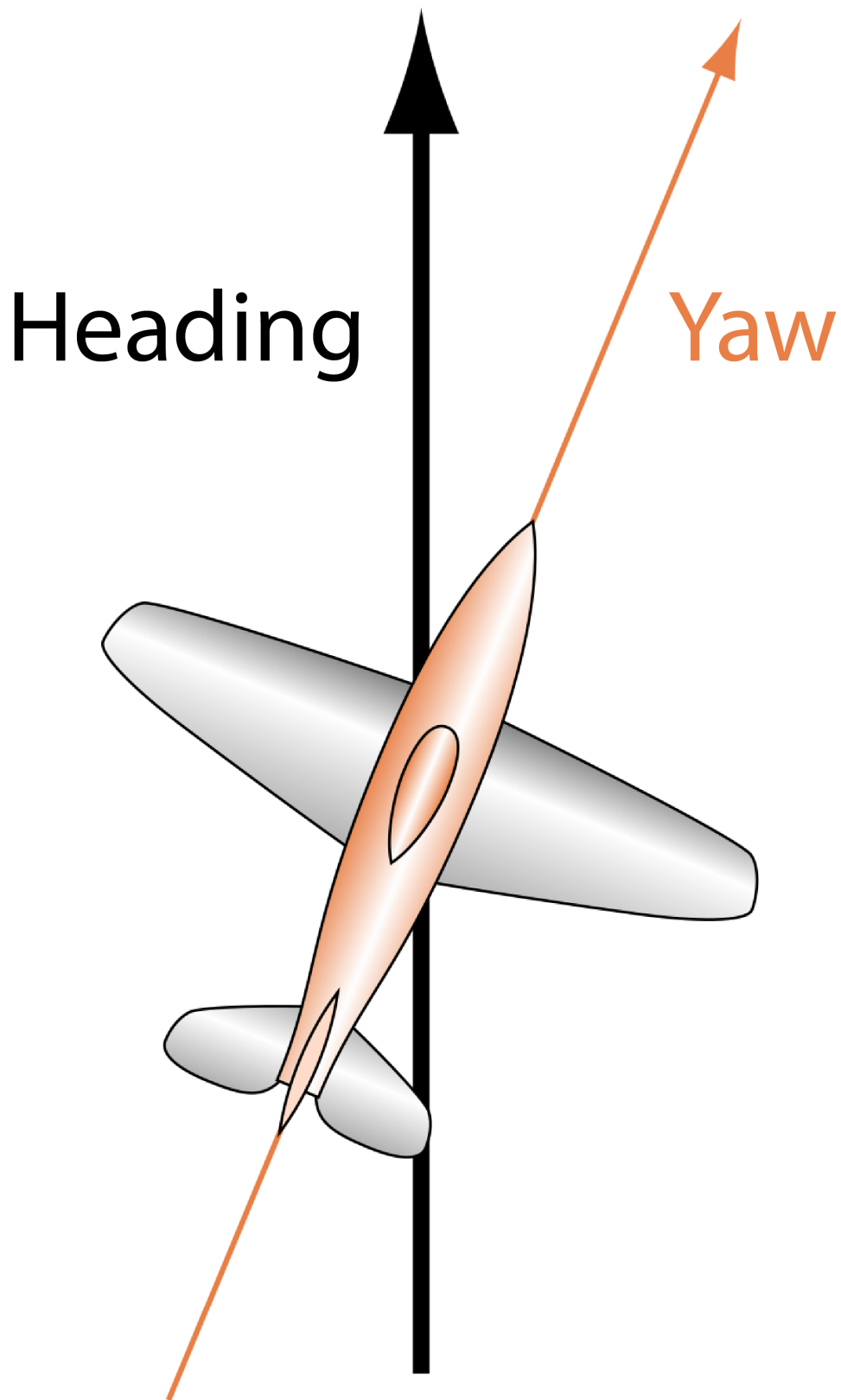

Direction names

Axes

All signs are defined according to the **international aeronautical axes convention**:

Any deflection that generates **positive rotational forces** relative to the aircraft's aerodynamic center is considered **positive**, except for the "**y**" axis (**elevator**), where downward movement is considered **negative**.

For example, when the elevator moves down, it generates a positive pitch, so the elevator is considered **positive** in the lower position. Main Actuator Rules:

Actuator	Positive	Negative
Elevator	Down	Up
Rudder	Right	Left
Right Aileron	Up	Down
Left Aileron	Down	Up
Tail Rotor	Right	Left

Additionally, rotation names are summarized in the figure below:

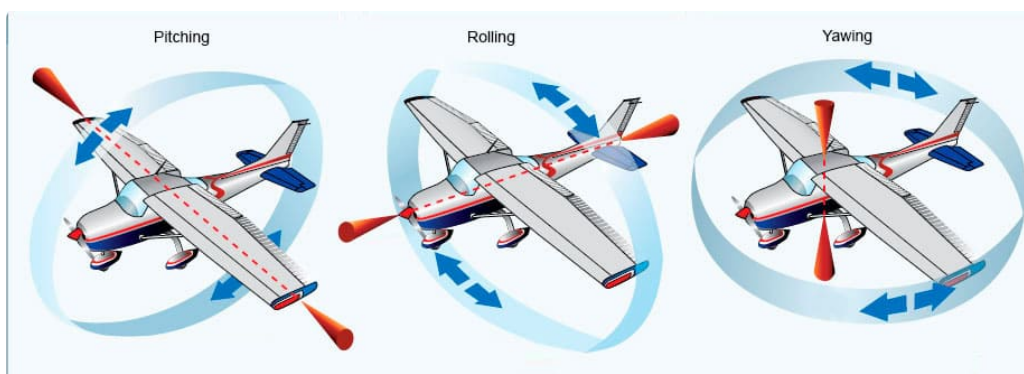

Rotation names

Core architecture

Veronte Autopilot 1x is equipped with a Dual-Core Microcontroller. Both cores, hereinafter called **Core 1 (C1)** and **Core 2 (C2)**, work together to perform information processing operations efficiently and to coordinate the activities of other system components.

It is crucial to understand the performance of C1 and C2 in order to properly handle Autopilot 1x tasks.

- **Core 1:** It presents the following operation threads.
 - **High:** 1kHz guaranteed. Hardware interrupt in charge of certain critical or high-priority tasks which must be executed with a constant and predictable frequency.

Note

There is a permitted frequency fluctuation of 1%.

- **Low:** Not guaranteed rate. In charge of non-priority tasks which tolerate non-guaranteed time consistency.
- **Core 2:** Execution rate of 400 Hz (configurable from [1x PDI Builder](#) application).

Task distribution

Tasks distribution between processors:

Core 1		Core 2
High	Low	

Core 1		Core 2
<ul style="list-style-type: none"> • Sensors reading • FTS Management • I/O management (data from peripherals to internal pre-processing queues) 	<ul style="list-style-type: none"> • Telemetry and logs management • Communication management • Files management • Additional helper tasks • SD writing 	<ul style="list-style-type: none"> • Guidance, Navigation and Control (GNC) • Mission updating • Automations management • RAM writing

A proper comprehension of how cores manage different tasks, considering the priorities and execution rates previously explained, may be valuable to avoid delays in data processing and achieving a balanced functioning of the Veronte system.

Aspects to be considered:

- **C1 and C2 information interchange:** Cores share information through the **Cross-Core queue**, hence overfilling this queue may result in late processing of data.
- **Tasks distribution between C1 threads:** If acquisition tasks take too much processing time, C1 low task may not be executed as expected.
- **C1 High interruptions:** C1 high may interrupt C1 low task execution. In this case, C1 low will continue its execution at the same point once high priority tasks are fulfilled.

Monitoring variables

Distributing resources is decisive for the proper functioning of the system. For that reason, core-related values are monitored.

Note

For further information regarding these variables, please consult their IDs in the [Lists of Variables](#) section of the present manual.

C1 is monitored by the following variables:

Core 1	
High	Low
	<ul style="list-style-type: none"> • C1 Low Frequency Fail (BIT 400) • CIO Max Time (RVar 2054) • CIO Average Time (RVar 2055) • CIO Running Frequency (RVar 2057)

Core 1	
<ul style="list-style-type: none">• Acquisition step missed (BIT 402)• CIO Hi Overload warning (BIT 403)• Acquisition Task Timestep (RVar 2047)• Acquisition Task Maximum Timestep (RVar 2048)• Acquisition Task Average CPU Ratio (RVar 2050)• Acquisition Task Maximum CPU Ratio (RVar 2051)• Acquisition Task Average Time (RVar 2052)• Acquisition Task Maximum Time (RVar 2053)• Identifier of max duration step in acquisition (UVar 399)	

C2 is monitored by the following variables:

Core 2

- GNC Fail (BIT 401)
- GNC Realtime Error (BIT 404)
- GNC Task Average CPU Ratio (RVar 2094)
- GNC Task Maximum CPU Ratio (RVar 2095)
- GNC Task Average Time (RVar 2096)
- GNC Task Maximum Time (RVar 2097)
- GNC Task Maximum Timestep (RVar 2098)
- Max Duration of Step in GNC (RVar 2099)
- GNC Timestep (RVar 2903)
- Counter for C2 system (UVar 20)

Cross-Core queue is monitored by the following variables:

Cross-Core Queue

- Cross Core Message Queue CPU Ratio (RVar [2049](#))
- Cross-Core Message Queue Usage (RVar [2056](#))

Data Transmission

Veronte Autopilot 1x uses the [Veronte Communicatin Protocol \(VCP\)](#) for its communication with other **Veronte devices** or **Veronte applications**, such as **Veronte Ops**.

Communication originates from any [COM Manager port](#) and is sent/received through any interface connected to it (e.g. USB ↔ Commgr port 0).

Autopilot 1x will send:

- 1 VCP packet per **vector telemetry**.
- 1 VCP packet of **complementary vector telemetry**; only in case a widget whose variables have not been previously added to the telemetry configuration is added in [Veronte Ops](#).

Note

Complementary vector telemetry always runs at a frequency of 10 Hz (not configurable) and variables are sent uncompressed.

- 1 VCP packet of **health status**.
- 1 VCP packet to update the **route** traced in **Veronte Ops**.

Important

A VCP message contains **11 bytes** of addresses (source and destination), CRC, header, etc., and **up to 255 bytes** of **data for telemetry vectors**.

The maximum packet size supported by **VCP** is **266 bytes**. For more information on the VCP packet, read the [Message structure](#) section of the **VCP** user manual.

Thus, it is up to the user to determine, based on its configuration, the amount of data in bytes to be sent from connected devices such as Radios, SatComs, etc., making sure that the bandwidth of the device is enough.

 **Tip**

Functional tests such as monitoring the value of the variables related to the interface used are recommended.

For example, if a radio connected to the RS232 is used for communication to the Ground Control Station (GCS), it is highly advised to monitor the variables:

- [RVar 48 - SCI-D Rx Rate \(RS232\)](#)
- [RVar 49 - SCI-D Tx Rate \(RS232\)](#)

Lists of interest

This section contains all the lists with information of interest for the user.

Activation System Error bits

The **System Error** variable is indicated by [bit number 7](#). This bit checks whether the system is running properly. If one of certain malfunctions occur, the **System Error** will be set as 0 and the FTS will be activated. Otherwise, if everything is OK, it will remain as 1.

The **System Error** is triggered and set as 0 if one of the following unwanted events happens:

- **CIO low** has a frequency lower than 10 Hz. This error is indicated with a 0 in [bit 400](#).
- **CIO high** has a frequency lower than 990 Hz. This error is indicated with a 0 in [bit 402](#).
- **GNC** is 'dead'. This event is indicated with a 0 in [bit 401](#).
- **GNC Realtime Error** because a GNC Step has been missed. This event is indicated with a 0 in [bit 404](#).
- **System Power Up Error bit**. The initial value of this bit depends on the values of the bits listed below and represents their state at power-up. This error is indicated with a 0 in [bit 12](#) if any of the following errors happens:
 - **RAM allocation** is in error state due to trying to use more memory than available. This error is indicated with a 0 in [bit 8](#).
 - **PDI files** have a wrong configuration. This is indicated by a 0 in [bit 9](#).
 - **Main Power supply A** is in error state. This error is indicated with a 0 in [bit 117](#) if any of the following errors happens:
 - **Input supply voltage** is not between 6.5 and 36 V. This voltage is measured by [RVar 400](#).
 - **Voltage received by Veronte through 5V port** is not between 4.75 and 5.25 V. This voltage is measured by [RVar 402](#).
 - **Voltage received by Veronte through 3.6V port** is not between 3.42 and 3.78V. This voltage is measured by [RVar 404](#).

- **File system manager** is in error state. This event is indicated with a 0 in [bit 6](#).
- **Core 1** has a memory overflow allocated for local variables. This error is indicated with a 0 in [bit 16](#).
- **Core 2** has a memory overflow allocated for local variables. This error is indicated with a 0 in [bit 17](#).
- Any user bit configured as **safety bit** is 0. [User bits](#) are 1200 to 1499.

Status Message variables

The variables contained in the Veronte Autopilot 1x status message are the following.

Type	ID	Name
UVar	0	Actuator Mode
UVar	1	Phase Identifier
RVar	6	Yaw
RVar	7	Pitch
RVar	8	Roll
BIT	100	Position Not Fixed
UVar	201	Current Section
UVar	204	Current patchset ID (needed for guidance display)
RVar	300	Relative Timestamp
RVar	505	North Ground Velocity
RVar	506	East Ground Velocity

Type	ID	Name
RVar	507	Down Ground Velocity
UVars	-	<p>Guidance calculation identifier (needed for guidance display).</p> <p>It can be one of these variables depending on the guidance used:</p> <ul style="list-style-type: none"> • ID 80: Detour calculation identifier • ID 81: Approach calculation identifier • ID 82: Climb calculation identifier • ID 83: Cruise calculation identifier • ID 84: Rendezvous calculation identifier • ID 85: Taxi calculation identifier • ID 86: VTOL calculation identifier

Extended Status Message variables

Information about the Veronte Autopilot 1x extended status message is contained in the following set of **bit** variables.

 **Note**

The **Extended Status Message** is only sent if one of the bits changes its value.

ID	Name
5	Power Error
6	File System Error
8	Memory allocation Error
9	PDI Error
12	System Power Up Error
14	FTS-1 Feedback (>=V4.5)
15	FTS-2 Feedback (>=V4.5)
16	Stack C1 usage FAIL
17	Stack C2 usage FAIL
49	CPU temperature

ID	Name
	above 398.15K
50	Sensors Error
51	IMU 0 Error
52	IMU 1 Error
53	Magnetometer 0 Error
73	CAN-A Error
74	CAN-B Error
87	GNSS1 Module Error
88	GNSS2 Module Error
117	Main Power Error
118	SUC Power Error
400	C1 Low Frequency Fail
401	GNC Fail
402	Acquisition step missed

ID	Name
403	CIO Hi Overload warning

List of Addresses

Every Embention device communicate with other devices/tools using its address through [VCP](#).

The following list contains all these addresses:

Address	Recognized as	Description
0	Dummy for pdi builders	Dummy for pdi builder
1	Cloud	Veronte Cloud address
2	Vlink	Address used by Veronte Link app to communicate with Veronte units
2-3	App + Address	Veronte applications addresses. App 2 is the one used by default by Veronte applications,

Address	Recognized as	Description
		although App 3 is also available
255-511	App dynamic + Address	Dynamic addresses for Veronte applications
998	Broadcast	To all devices on a network
999	Address unknown	This address can be used for a device that does not have a valid address configured
1000-1777	1x v4.0 + Address	Specific address of an Autopilot 1x with hardware version 4.0
1778-3999	1x v4.5 + Address	Specific address of an Autopilot 1x with hardware version 4.5
4000-17999	1x v4.8 + Address	Specific address of an Autopilot 1x with

Address	Recognized as	Description
		hardware version 4.8
18000-19899	1x BCS + Address	Specific address of a BCS unit
19900-19999	1x v4.7. For internal use only + Address	Specific address of an Autopilot 1x with hardware version 4.7
20000-21999	Smart Can Isolator + Address	Specific address of a Smart Can Isolator unit
30000-31999	MC01 + Address	Specific address of a MC01 unit
32000-34999	MC24 motor controller + Address	Specific address of a MC24 unit
35000-35299	MC110 motor controller + Address	Specific address of a MC110 unit
35300-39999	MC110 v2 motor controller + Address	Specific address of a MC110 v2 unit
40000-41999	CEX + Address	Specific address of a CEX with

Address	Recognized as	Description
		hardware version 1.2
42000-43999	MEX + Address	Specific address of a MEX unit
44000-49999	CEX2 + Address	Specific address of a CEX with hardware version 2.0
50000-51089	Arbiter v1.0 + Address	Specific address of an Arbiter with hardware version 1.0
51090-51999	Arbiter v1.2 + Address	Specific address of an Arbiter with hardware version 1.2
52000-59999	Arbiter v1.8 + Address	Specific address of an Arbiter with hardware version 1.8
60000-65535	Reserved + Address	Reserved addresses
65536-69631	Virtual v4.0 + Address	Specific address of a Virtual Autopilot 1x with hardware version 4.0

Address	Recognized as	Description
69632-73727	Virtual v4.5 + Address	Specific address of a Virtual Autopilot 1x with hardware version 4.5
73728-77823	Virtual v4.8 + Address	Specific address of a Virtual Autopilot 1x with hardware version 4.8

Lists of Variables

This section shows all the variables employed by **Veronte Autopilot 1x**. All of them can be read and sent through telemetry.

These variables are classified into two main groups:

- **System variables:** Non-writable by the user.
- **User variables:** Writable by the user, marked in the tables below as .

Important

Variables labeled as "**Deprecated**" are no longer used by the system.

In order to avoid system incompatibilities, deprecated variables are only written by the autopilot when migrating a configuration from a previous version in which the variable was not obsolete.

When a configuration is built from scratch, these variables must be defined by the user to be used.

Thus, users are responsible for their correct assignment.

BIT Variables

Warning

Bit Variables displayed on **Veronte Ops** labels will be shown as Red/Green depending on their state.

Red stands for **0** and **Green** for **1**, changing the name displayed accordingly to the BIT value.

ID	Name	Description
0	Always Fail	This signal is always fail - 0 for fail, 1 for OK
1	Always OK	This signal is CIO always OK - 0 for fail, 1 for OK
2	License Check Pending	License state - 0 for license check pending, 1 for license checked
3	System Not Ready to Start	System is ready to start operating - 0 for not ready, 1 for ready
4	No Writing Telemetry	Telemetry is properly sending/receiving - 0 for no, 1 for yes
5	Power ERROR	Power supply state - It will be 0

ID	Name	Description
		<p>if any of the following conditions happens:</p> <ul style="list-style-type: none"> • Bit 117 is zero (power for Veronte has a failure) • Bit 118 is zero (power for SuC has a failure)
6	File System ERROR	<p>System file manager - Dependent on File system status (UVar 96)</p> <ul style="list-style-type: none"> • 0 for Error: if File system status > 0 • 1 for running OK: if File system status == 0
7	System ERROR	<p>This bit checks whether the system is running properly. 0 for</p>

ID	Name	Description
		system error, 1 for system OK.
8	Memory allocation ERROR	RAM allocation - 0 for Error, i.e. trying to use more than available memory, 1 for memory allocation ok
9	PDI ERROR	<p>PDI files - Dependent on PDI error source (UVar 50)</p> <ul style="list-style-type: none"> • 0 for wrong PDI configuration: if PDI Error Source > 0 • 1 for running OK: if PDI Error Source == 0
10	CIO Low or C2 ERROR (Deprecated)	<p>CIO low or C2 failed. Bits 400 and 401 are recommended instead</p> <p>- 0 for CIO low or C2 failed, 1 for</p>

ID	Name	Description
		CIO high and C2 OK <div style="border-left: 2px solid orange; padding-left: 5px; background-color: #fff9c4;"> <p style="margin: 0;">Warning Deprecated variable</p> </div>
11	4x CAN Fail	For more information, check BIT Variables - 4x Software Manual
12	System Power Up ERROR	Power up - 0 for Error, 1 for OK
13	Reset and Write Disabled	Reset and non-operation PDI writes are allowed - 0 for disabled, 1 for enabled
14	FTS-1 Feedback (>=V4.5)	Flight Termination System 1, microcontroller state for hardware version 4.7 or higher - 0 for Error, 1 for running OK
15		Flight Termination System 2,

ID	Name	Description
	FTS-2 Feedback (>=V4.5)	microcontroller state for hardware version 4.7 or higher - 0 for Error, 1 for running OK
16	Stack C1 usage FAIL	0 for Fail, i.e. stack overflow of Core 1, 1 for OK
17	Stack C2 usage FAIL	0 for Fail, i.e. stack overflow of core 2, 1 for OK
18	PDI disabled	PDI Mode - 0 for disabled, 1 for enabled
 20-46	4X Bit variables	For more information, check BIT Variables - 4x Software Manual
47	4X Watchdog ERROR	<div style="border-left: 2px solid #0070C0; padding-left: 10px; background-color: #E6F2FF;"> <p>Note For version 4.7 or higher</p> </div> <p>For more information, check BIT Variables - 4x</p>

ID	Name	Description
		Software Manual
49	CPU temperature above 398.15K	CPU temperature warning - 0 for CPU temperature above 398.15K (125°C), 1 for CPU temperature below 398.15K (125°C)
50	Sensors ERROR	Sensors state - 0 for Error, 1 for running OK Selected sensors are not working or, if external sensors have been selected, they are not connected
51	IMU 0 ERROR	Sensor IMU 0 - 0 for Error, 1 for OK
52	IMU 1 ERROR	Sensor IMU 1 - 0 for Error, 1 for OK
53	Magnetometer 0 ERROR	Internal 0 Magnetometer - 0 for Error, 1 for OK

ID	Name	Description
55	Sensor-External Magnetometer (LIS3MDL)	External LIS3MDL magnetometer - 0 for Error, 1 for OK
56	Sensor-Static pressure 0	Static Pressure Sensor 0 - 0 for Error, 1 for OK
57	Sensor-Static pressure 1	Static Pressure Sensor 1 - 0 for Error, 1 for OK
58	Sensor-Dynamic pressure	Dynamic Pressure Sensor 0 - 0 for Error, 1 for OK
59	Sensor-External I2C devices ERROR	0 for Error, 1 for OK
60-64	Sensor-External I2C device 0-4 ERROR	External communication I2C device 0-4 - 0 for Error, 1 for OK
65	SCI-A Transmitting (LTE/EXT. UART)	Serial Communication Interface LTE/EXT. UART transmission - 0 for Error, 1 for OK

ID	Name	Description
66	SCI-A Receiving (LTE/ EXT. UART)	Serial Communication Interface LTE/EXT. UART reception - 0 for Error, i.e. not receiving, 1 for OK, i.e. receiving
67	SCI-B Transmitting (LOS)	Serial Communication Interface LOS transmission - 0 for Error, 1 for OK
68	SCI-B Receiving (LOS)	Serial Communication Interface LOS reception - 0 for Error, i.e. not receiving, 1 for OK, i.e. receiving
69	SCI-C Transmitting (RS485)	Serial Communication Interface RS485 transmission - 0 for Error, 1 for OK
70	SCI-C Receiving (RS485)	Serial Communication Interface RS485 reception

ID	Name	Description
		- 0 for Error, i.e. not receiving, 1 for OK, i.e. receiving
71	SCI-D Transmitting (RS232)	Serial Communication Interface RS232 transmission - 0 for Error, 1 for OK
72	SCI-D Receiving (RS232)	Serial Communication Interface RS232 reception - 0 for Error, i.e. not receiving, 1 for OK, i.e. receiving
73	CAN-A ERROR	CAN A state - 0 for Error, 1 for OK
74	CAN-B ERROR	CAN B state - 0 for Error, 1 for OK
75	CAN-A Warning	CAN A state - 0 for Warning, 1 for OK
76	CAN-B Warning	CAN B state - 0 for Warning, 1 for OK
77		

ID	Name	Description
	Vectornav GPS not fixed	0 for not fixed, 1 for fixed
78	Vectornav IMU ERROR	0 for Error, 1 for OK
79	Vectornav Mag/Press ERROR	0 for Error, 1 for OK
80	Vectornav GPS ERROR	0 for Error, 1 for OK
81	Vectornav Navigation ERROR	Navigation state - 0 for Error, 1 for OK
82	Sensor- External Magnetometer (HSCDTD008A)	External HSCDTD008A magnetometer - 0 for Error, 1 for OK
83	IMU 2 ERROR	Sensor IMU 2 - 0 for Error, 1 for OK
84	Sensor-Static pressure 2	Static Pressure Sensor 2 - 0 for Error, 1 for OK
85	Magnetometer 1 ERROR	Internal 1 Magnetometer - 0 for Error, 1 for OK

ID	Name	Description
86	Sensor- External Magnetometer (MMC5883MA)	External MMC5883MA magnetometer - 0 for Error, 1 for OK
87	GNSS1 Module ERROR	GPS module 1 state - 0 for Error, 1 for OK
88	GNSS2 Module ERROR	GPS module 2 state - 0 for Error, 1 for OK
89	Sensor- External Magnetometer (RM3100)	External RM3100 magnetometer - 0 for Error, 1 for OK
90	IMU3 ERROR	Sensor IMU 3 - 0 for Error, 1 for OK
91	Magnetometer 2 ERROR	Internal 2 Magnetometer - 0 for Error, 1 for OK
92	Magnetometer reserved	0 for Error, 1 for OK
93	SCI Expander (v4.8+)	SCI Expander for hardware version

ID	Name	Description
		4.8 or higher - 0 for Error, 1 for OK
96	SCI-A ERROR (LTE/EXT. UART)	SCI A (LTE/EXT. UART) state - 0 for Error in this port (invalid format or configuration), 1 for OK
97	SCI-B ERROR (LOS)	SCI B (LOS) state - 0 for Error in this port (invalid format or configuration), 1 for OK
98	SCI-C ERROR (RS485)	SCI C (RS485) state - 0 for Error in this port (invalid format or configuration), 1 for OK
99	SCI-D ERROR (RS232)	SCI D (RS232) state - 0 for Error in this port (invalid format or configuration), 1 for OK
100	Position not fixed	GNSS data reception - 0 for not receiving, 1

ID	Name	Description
		for receiving (Position fixed)
101	No valid SRTM at UAV position	0 for not valid, 1 for valid
102-103	CAN-A-B Receiving ERROR	CAN A-B communication - 0 for Error, i.e. not receiving, 1 for OK, i.e. receiving
104-105	Stick PPM 0-1 not detected	Stick PPM 0-1 - 0 for not detected, 1 for detected
 106	Magnetic field out of bounds (Deprecated)	0 for magnetic field out of bounds, 1 for OK Warning Deprecated variable
107	INS navigation OFF	0 for INS navigation OFF, 1 for INS navigation ON
108-109	Stick PPM 2-3 not detected	Stick PPM -3 - 0 for not detected, 1 for detected

ID	Name	Description
 110	Stick Not Detected	Stick detection - 0 for not detected, 1 for OK
111-112	CAN-A-B Transmitting ERROR	CAN signals A-B - 0 for Error, i.e. not transmitting, 1 for OK, i.e. transmitting
113	Iridium not ready	Iridium ready state - 0 for not ready, 1 for ready
114	No valid Geoid at UAV position	0 for no valid geoid at UAV position, 1 for valid geoid at UAV position
115	EKF: Condition Number ERROR	Extended Kalman Filter state - 0 for Error, 1 for OK
116	Radar Altimeter CAN-RX ERROR	Radar Altimeter Reception State - 0 for Error, 1 for OK
117	Main Power ERROR	Main power supply A. It will be 0 (indicating error state) if any of the following errors

ID	Name	Description
		<p>happen:</p> <ul style="list-style-type: none"> • Input supply voltage is not between 6.5 and 36 V. This voltage is measured by RVar 400. • Voltage received by Veronte through 5V port is not between 4.75 and 5.25 V. This voltage is measured by RVar 402. • Voltage received by Veronte through 3.6V port is not between 3.42 and 3.78V. This voltage is measured by RVar 404.
118	SUC Power ERROR	Power supply for system on microchip. It will

ID	Name	Description
		<p>be 0 (indicating error state) if any of the following errors happen:</p> <ul style="list-style-type: none"> • Voltage received by Veronte through 3.3V port is out of range. This voltage is measured by RVar 401. • Voltage received by Veronte SUC is out of range. This voltage is measured by RVar 403.
119	Not hovering guidance	Hovering guidance state - 0 if cruise guidance is not hovering, 1 if cruise guidance is hovering
120-123	Pulse 0-3 not detected	Pulse 0-3 detection - 0 for pulse not

ID	Name	Description
		detected, 1 for detected
 124-129	4X Bit variables	For more information, check BIT Variables - 4x Software Manual
130	EKF Navigation ERROR	Extended Kalman Filter navigation state - 0 for Error, 1 for OK
131	No magnetic field data	Bit to indicate if there is magnetic field in the SD - 0 for No Magnetic field data, 1 for Magnetic field data OK
132	Route not finished	0 for Route not finished, 1 for Route finished
133	Operation ERROR	0 if an operation error has occurred, 1 if no operation error has occurred
134		Atmospheric parameters have

ID	Name	Description
	Atmosphere not calibrated	not been calibrated or received via command
135	Position command not received	The system is waiting for an initial position command to begin navigation
136	Yaw not initialized via command	Initial yaw orientation has not been initialized via operator command
137	Wind Estimation Command Not Received	0 if wind estimation was not initialized by command, 1 if wind estimation was initialized by command
139	Navigation not initialized	General navigation algorithms or states are not yet fully initialized
141	EKF height not teleported	A vertical position jump (teleport) in

ID	Name	Description
		the EKF is pending or failed
142	EKF lonlat not teleported	A horizontal position jump (teleport) in the EKF is pending or failed
150	External VCP Navigation ERROR	External VCP Navigation state - 0 for Error, 1 for OK
 160	External Var Navigation ERROR	External Var Navigation state - 0 for Error, 1 for OK
170	Selected Accelerometer ERROR	Selected accelerometer - 0 for Error, 1 OK, i.e. at least one of the selected accelerometers is OK
171	Selected Gyroscope ERROR	Selected gyroscope - 0 for Error, 1 O, i.e. if at least one of the selected gyroscopes is OK

ID	Name	Description
172	Bias Accelerometer Saturated	0 for bias Saturated, 1 for OK, i.e. not saturated
173	Bias Gyroscope Saturated	0 for bias Saturated, 1 for OK, i.e. not saturated
 180	External attitude	Kind of attitude calculation - 0 for External, 1 for Internal
182	FTS Activation (>=V4.5)	Flight Termination System activation, for version 4.5 or higher - 0 for not activated, 1 for activated <div style="border-left: 2px solid purple; padding-left: 10px; background-color: #f0f0f0;"> <p>Important This bit is not a FeedbackBit, i.e., it will not be activated automatically by the system, but acts as a user bit. Therefore, for</p> </div>

ID	Name	Description
		the FTS to be activated, this bit must be included in the Safety bits list.
181	Expected Magnetic Field At UAV Position Not Valid	The expected magnetic field at the UAV's current position is not valid
183	4X Selected	Current 1x Autopilot is the one selected by the arbiter - 0 when this AP is not the selected AP, 1 when this AP is the selected one
184	Custom FTS activation	A user-defined custom Flight Termination System activation has occurred
187	Dynamic Pressure Sensors ERROR	General error detected across all dynamic pressure (airspeed) sensors

ID	Name	Description
188	Static Pressure Sensors ERROR	Static Pressure Sensors status - 0 for Error, 1 for OK
189	Magnetometer Sensors ERROR	Magnetometer Sensors status - 0 for Error, 1 for OK
190	Interneer ultrasound position status ERROR	Interneer ultrasound position status - 0 for Error, 1 for OK
191	Interneer ultrasound angle status ERROR	Interneer ultrasound angle status - 0 for Error, 1 for OK
192	4G not connected	LTE/4G cellular module (SARA) is not connected to the network
200	GNSS1 Navigation Down	GNSS1 Navigation status - 0 for GNSS Navigation Down, i.e. not used, 1 for GNSS Navigation ON, i.e. used
201	DGNSS1 Input OFF	DGNSS1 Input status - 0 for DGNSS1 Input Off,

ID	Name	Description
		i.e. neither GNSS compass nor RTK activated, 1 for DGNSS1 Input ON, i.e. one of them activated
202	DGNSS1 Navigation OFF	DGNSS1 Navigation status - 0 for DGNSS1 Navigation Off, i.e. neither GNSS compass nor RTK used, 1 for DGNSS1 Navigation ON, i.e. one of them used
203	GNSS1 Survey In OFF	GNSS1 Survey In status - 0 for GNSS1 Survey In Off, i.e. neither GNSS compass survey nor RTK OFF, 1 for GNSS1 Survey In, i.e. one of them ON
204	No DGNSS1 Float Solution	0 for no DGNSS1 Float Solution nor RTK, 1 for DGNSS1 Float Solution or RTK

ID	Name	Description
205	No DGNSS1 Fixed Solution	0 for no DGNSS1 Fixed Solution nor RTK, 1 for DGNSS1 Fixed Solution or RTK
206	DGNSS1 Relative Position Invalid	0 for invalid navigation position, 1 for valid navigation position
207	DGNSS1 not Moving baseline mode	0 for not Moving baseline mode, 1 for Moving baseline mode
210	DMA peripheral for SPIA A ERROR	DMA peripheral for SPIA A - 0 for Error, 1 for OK
211	DMA peripheral for MCBSP A ERROR	DMA peripheral for MCBSP A - 0 for Error, 1 for OK
213	Accelerometer Decimal Var Sensor 0 Error	Accuracy or variance error for accelerometer decimal variable sensor 0
214		Accuracy or variance error for

ID	Name	Description
	Accelerometer Decimal Var Sensor 1 Error	accelerometer decimal variable sensor 1
215	Gyroscope Decimal Var Sensor 0 Error	Accuracy or variance error for gyroscope decimal variable sensor 0
216	Gyroscope Decimal Var Sensor 1 Error	Accuracy or variance error for gyroscope decimal variable sensor 1
217	Magnetometer Decimal Var Sensor 0 Error	Accuracy or variance error for magnetometer decimal variable sensor 0
218	Magnetometer Decimal Var Sensor 1 Error	Accuracy or variance error for magnetometer decimal variable sensor 1
219	Static Pressure Decimal Var Sensor 0 Error	Accuracy or variance error for static pressure decimal variable sensor 0

ID	Name	Description
220	Static Pressure Decimal Var Sensor 1 Error	Accuracy or variance error for static pressure decimal variable sensor 1
221	Dynamic Pressure Decimal Var Sensor 0 Error	Accuracy or variance error for dynamic pressure decimal variable sensor 0
222	Dynamic Pressure Decimal Var Sensor 1 Error	Accuracy or variance error for dynamic pressure decimal variable sensor 1
 230-293	4X Bit variables	For more information, check BIT Variables - 4x Software Manual
300	GNSS2 Navigation Down	GNSS2 Navigation status - 0 for GNSS Navigation Down, i.e. not used, 1 for GNSS Navigation ON, i.e. used
301		

ID	Name	Description
	DGNSS2 Input OFF	DGNSS2 Input status - 0 for DGNSS2 Input Off, i.e. neither GNSS compass nor RTK activated, 1 for DGNSS2 Input ON, i.e. one of them activated
302	DGNSS2 Navigation OFF	DGNSS2 Navigation status - 0 for DGNSS2 Navigation Off, i.e. neither GNSS compass nor RTK used, 1 for DGNSS2 Navigation ON, i.e. one of them used
303	GNSS2 Survey In OFF	GNSS2 Survey In status - 0 for GNSS2 Survey In Off, i.e. neither GNSS compass survey nor RTK OFF, 1 for GNSS2 Survey In, i.e. one of them ON
304	No DGNSS2 Float Solution	0 for no DGNSS2 Float Solution nor



ID	Name	Description
		RTK, 1 for DGNSS2 Float Solution or RTK
305	No DGNSS2 Fixed Solution	0 for no DGNSS2 Fixed Solution nor RTK, 1 for DGNSS2 Fixed Solution or RTK
306	DGNSS2 Relative Position Invalid	0 for invalid navigation position, 1 for valid navigation position
307	DGNSS2 not Moving baseline mode	0 for not Moving baseline mode, 1 for Moving baseline mode
308	SCI-E Transmitting (LTE)	SCI-E Transmitting (LTE) - 0 for Error, 1 for OK
309	SCI-E Receiving (LTE)	SCI-E Receiving (LTE) - 0 for Error, i.e. not receiving, 1 for OK, i.e. receiving
310	SCI-F Transmitting (LTE Aux.)	SCI-F Transmitting (LTE Aux.) - 0 for Error, 1 for OK







ID	Name	Description
311	SCI-F Receiving (LTE Aux.)	SCI-F Receiving (LTE Aux.) - 0 for Error, i.e. not receiving, 1 for OK, i.e. receiving
312	SCI E ERROR (LTE)	SCI-E (LTE) - 0 for Error, i.e. not receiving, 1 for OK, i.e. receiving
313	SCI F ERROR (LTE Aux.)	SCI-F (LTE Aux.) - 0 for Error, i.e. not receiving, 1 for OK, i.e. receiving
329	3.3V Power Source ERROR	0 for Error, 1 for OK
330	Jetibox COMM ERROR	Jetibox is communicating properly - 0 for Error, 1 for OK
331	CEX HI-3210 ERROR	HI-3210 is working properly - 0 for Error, 1 for OK
351	Planet SATCOM connection Fail	Planet SATCOM is connected - 0 for Error, 1 for OK
370-371	Smart Can Isolator A-B	





ID	Name	Description
	Domain ERROR	0 for Error, 1 for OK
400	C1 Low Frequency Fail	<p>C1 Low Frequency - Dependent on CIO Running Frequency (RVar 2057) (C1 low frequency)</p> <ul style="list-style-type: none"> • 0 for Fail → CIO Running Frequency < 10 Hz • 1 for OK → CIO Running Frequency > 10 Hz
401	GNC Fail	<p>0 for Fail ('dead'), 1 for OK ('alive') - Dependent on Counter for C2 system (UVar 20)</p>
402	Acquisition step missed	



ID	Name	Description
		<ul style="list-style-type: none"> • 0 for Acquisition step missed → C1 hi frequency fluctuation is higher than permitted (1%). • 1 for Acquisition Task OK → C1 hi frequency fluctuation is under set limits (1%).
403	C10 Hi Overload warning	C1 Hi Overload - Dependent on Acquisition Task Maximum CPU Ratio (RVar 2051)







ID	Name	Description
		<ul style="list-style-type: none"> <li data-bbox="715 257 976 616">• 0 for Acquisition Task overload → Acquisition Task Maximum CPU Ratio > 90% <li data-bbox="715 638 976 996">• 1 for Acquisition Task usage OK → Acquisition Task Maximum CPU Ratio ≤ 90% <div data-bbox="678 1041 976 1299" style="border-left: 2px solid #0070C0; padding-left: 10px; margin-top: 10px;"> <p data-bbox="790 1070 869 1104">Note</p> <p data-bbox="734 1126 925 1265">Non-recoverable variable</p> </div>
404	GNC Realtime ERROR	



ID	Name	Description
		<ul style="list-style-type: none"> • 0 if C2 frequency < configured frequency (tolerance of 6 microseconds) • 1 if C2 frequency = configured frequency (tolerance of 6 microseconds)
405	Reserved	0 for Error, 1 for OK
480	MC01 Stepper direction output ERROR	0 for Error, 1 for OK
481	MC01 Brushless driver fault	0 for Error, 1 for OK
482	MC Hall Sensor ERROR	0 for Error, 1 for OK
 483	MC Sin/Cos Sensor ERROR	0 for Error, 1 for OK
 484	MC general health ERROR	0 for health Error, 1 for status OK

ID	Name	Description
 485	MC Current sensing ERROR	0 for Error, 1 for OK
 486	MC Phase U Current Calibration ERROR	ADC phase U calibration status - 0 for not calibrated, 1 for calibration OK
 487	MC Phase V Current Calibration ERROR	ADC phase V calibration status - 0 for not calibrated, 1 for calibration OK
 488	MC Phase W Current Calibration ERROR	ADC phase W calibration status - 0 for not calibrated, 1 for calibration OK
 489	MC Maximum Temperature ERROR	Maximum power module temperature exceeded - 0 for Error (exceeded), 1 for OK
 490	MC Phase V ERROR	Power module driver phase error reported - 0 for Error, 1 for OK







ID	Name	Description
 491	MC General Driver ERROR	Power module driver error reported - 0 for Error, 1 for OK
 492	MC Over-current AC	Current AC side limit exceeded - 0 for Error (exceeded), 1 for OK
 493	MC Over-voltage Advertisement	Over-voltage DC side limit advertisement exceeded - 0 for Error (exceeded), 1 for OK
 494	MC Over-voltage Caution	Over-voltage DC side limit caution exceeded - 0 for Error (exceeded), 1 for OK
495	MC Under-voltage Latching	Critical under-voltage DC side limit violation - 0 for Error, 1 for OK
496	MC Under-voltage ON Latching	Non critical under-voltage DC side limit violation - 0 for Error, 1 for OK









ID	Name	Description
497	MC RMS imbalance	Current AC side imbalance - 0 for Error, 1 for OK
498	MC Open DC fault	Open-circuit DC side fault - 0 for Error, 1 for OK
499	MC Over-current DC	Current DC side limit exceeded - 0 for Error (exceeded), 1 for OK
 500	Ground effect compensation variance disabled	Ground effect e2 compensation status - 0 for disabled, 1 for enabled
 501	Ground effect compensation measurement disabled	Ground effect correction limit compensation status - 0 for disabled, 1 for enabled
502	No SRTM data	Bit to indicate if there is SRTM in the SD - 0 for No SRTM data, 1 for SRTM data OK
503	No geoid data	





ID	Name	Description
		Bit to indicate if there is Geoid data in the SD - 0 for No geoid data, 1 for Geoid data OK
600	Wind Estimation OFF	0 for disabled, 1 for enabled
 700-731	Servo 0-31 Saturated	0 for Saturated, 1 for OK
 732-733	Phase U-W ERROR	0 for Error, 1 for OK
 734	HW DC link ERROR	0 for Error, 1 for OK
 735-736	HW over-current AC-DC ERROR	0 for Error, 1 for OK
 737	HW Ground Fault Detection ERROR	0 for HW Ground Fault Detection Error, 1 for HW Ground Fault Detection OK
 738	HW Power Regulator ERROR	0 for HW Power Regulator error, 1 for HW Power Regulator OK



ID	Name	Description
 739	HW trip PWM ERROR	0 for HW general error to trip PWM, 1 for HW general to trip PWM OK
 740	Disconnected HW battery	0 for Battery disconnected, 1 for Battery connected
 741	DC current calibration ERROR	0 for DC current calibration Error, 1 for DC current calibration OK
742	Estimation Position (Deprecated)	Position estimation error (Deprecated sensor/logic status)
743	Speed reference tracking ERROR	Motor Controller failed to track the commanded speed reference
744	Position Sensor ERROR	A generic error was detected in the position sensor hardware
745	SIN/COS 1 Calibration ERROR	Calibration error detected for Sin/ Cos sensor 1





ID	Name	Description
746	SIN/COS 2 Calibration ERROR	Calibration error detected for Sin/ Cos sensor 2
747	Low energy ERROR	Input energy level is too low for reliable motor controller operation
748	RPM Command Message ERROR	Error detected in the RPM command message format or reception
757	A temperature sensor error was detected	An internal VMC temperature sensor has reported an out-of-range value
758	A MOSFET de-saturation was detected	Hardware protection triggered by MOSFET de-saturation (over-current)
759	MOSFET driver is not ready	The MOSFET power driver stage is not ready for operation







ID	Name	Description
 800-815	PWM 0-15 GPIO OFF	PWM GPIO 0-15 communication State - 0 for Off, 1 for ON
 816-819	EQEP_A-I (GPIO 17-20) OFF	Input/Output State - 0 for Off, 1 for ON
820-822	RSSI LED 0-2 OFF	Received Signal Strength Indicator led state - 0 for Off, 1 for ON
 823	GPIO 5 (GPIO28) OFF	GPIO 5 Status (Low/High) - 0 for Off, 1 for ON
 824	GPIO 6 (GPIO61) OFF	GPIO 6 Status (Low/High) - 0 for Off, 1 for ON
 825	GPIO 7 (GPIO60) OFF	GPIO 7 Status (Low/High) - 0 for Off, 1 for ON
 826	GPIO 8 (GPIO59) OFF	GPIO 8 Status (Low/High) - 0 for Off, 1 for ON
 827	GPIO 9 (GPIO17) OFF	GPIO 9 Status (Low/High) - 0 for Off, 1 for ON





ID	Name	Description
 828	GPIO 10 (GPIO58) OFF	GPIO 10 Status (Low/High) - 0 for Off, 1 for ON
 829	GPIO 11 (GPIO16) OFF	GPIO 11 Status (Low/High) - 0 for Off, 1 for ON
 830	GPIO 12 (GPIO53) OFF	GPIO 12 Status (Low/High) - 0 for Off, 1 for ON
 831	GPIO 13 (GPIO20) OFF	GPIO 13 Status (Low/High) - 0 for Off, 1 for ON
 832	GPIO 14 (GPIO23) OFF	GPIO 14 Status (Low/High) - 0 for Off, 1 for ON
 833	GPIO 15 (GPIO51) OFF	GPIO 15 Status (Low/High) - 0 for Off, 1 for ON
 834	GPIO 16 (GPIO52) OFF	GPIO 16 Status (Low/High) - 0 for Off, 1 for ON
 835	GPIO 17 (GPIO49) OFF	GPIO 17 Status (Low/High) - 0 for Off, 1 for ON
 836	GPIO 18 (GPIO08) OFF	

ID	Name	Description
		GPIO 18 Status (Low/High) - 0 for Off, 1 for ON
 837	GPIO 19 (GPIO11) OFF	GPIO 19 Status (Low/High) - 0 for Off, 1 for ON
 838	GPIO 20 (GPIO10) OFF	GPIO 20 Status (Low/High) - 0 for Off, 1 for ON
 839	GPIO 21 (GPIO09) OFF	GPIO 21 Status (Low/High) - 0 for Off, 1 for ON
 900-931	Virtual GPIO 00-31 OFF	Virtual GPIO 00-31 Status (Low/High) - 0 for Off, 1 for ON
1000-1009	Simulation BIT 00-09 ERROR	0 for Error, 1 for OK
1010-1169	Custom msg 0-159 Rx ERROR	Custom message timeout - 0 for Error, 1 for OK
 1170-1171	Entrance EKF GNSS1-2 OFF	GNSS 1-2 information considered in EKF Navigation - 0 for entrance EKF GNSS OFF, 1 for ON



ID	Name	Description
		<p>EKF GNSS OFF may be because Position not fixed → EKF deactivated → INSS activated</p> <div style="border-left: 2px solid purple; padding-left: 10px; background-color: #f0f0f8;"> <p>Important This bit is not a FeedbackBit, i.e., it will not be activated automatically by the system, but acts as a user bit.</p> </div>
 1172	Entrance EKF GNSS EXT OFF	<p>External GNSS information considered in EKF Navigation - 0 for entrance EKF GNSS EXT OFF, 1 for ON</p>
 1173	Entrance EKF Internest OFF	<p>Internest information considered in EKF Navigation - 0 for entrance EKF internest OFF, 1 for ON</p>

ID	Name	Description
 1174	Entrance EKF GPSCOMPASS OFF	GNSS Compass information considered in EKF Navigation - 0 for entrance EKF GPSCOMPASS OFF, 1 for ON
 1175	Entrance EKF Magnetometer OFF	Magnetometer information considered in EKF Navigation - 0 for entrance EKF magnetometer OFF, 1 for ON
 1176	Entrance EKF Static press OFF	Static Pressure sensor information considered in EKF Navigation - 0 for entrance EKF static pressure OFF, 1 for ON
 1177	Entrance EKF Altimeter press OFF	Altimeter information considered in EKF Navigation - 0 for entrance EKF altimeter OFF, 1 for ON

ID	Name	Description
 1178	Entrance EKF Radar- altimeter press OFF	Radar Altimeter information considered in EKF Navigation - 0 for entrance EKF radar-altimeter OFF, 1 for ON
 1179	Entrance EKF DEM OFF	DEM information considered in EKF Navigation - 0 for entrance EKF DEM OFF, 1 for ON
 1183	External navigation sensor ERROR	External navigation sensor - 0 for Error, 1 for OK
 1184	External IMU 0 accelerometer ERROR	External IMU 0 accelerometer - 0 for Error, 1 for OK
 1185	External IMU 0 gyroscope ERROR	External IMU 0 gyroscope - 0 for Error, 1 for OK
 1186	External IMU 1 accelerometer ERROR	External IMU 1 accelerometer - 0 for Error, 1 for OK
 1187	External IMU 1 gyroscope ERROR	External IMU 1 gyroscope - 0 for Error, 1 for OK

ID	Name	Description
 1188	External magnetometer 0 ERROR	External magnetometer 0 - 0 for Error, 1 for OK
 1189	External magnetometer 1 ERROR	External magnetometer 1 - 0 for Error, 1 for OK
 1190-1191	Sniffer msg 0-1 Rx ERROR	Sniffer receiver message 0-1 - 0 for Error, 1 for OK
 1200-2199	User BIT 00-999 ERROR	User bit 0-999 - 0 for Error, 1 for OK
2200	BIT Dummy ERROR	Bit for configurable checks - 0 for Error, 1 for OK

Real Variables (RVar) - 32 Bits

ID	Name	Units/ Values	Description
 0	IAS (Indicated Airspeed)	m/s	Pitot-static measurement speed
 1	TAS (True Airspeed) (Deprecated)	m/s	Speed relative to the airmass in which the vehicle

ID	Name	Units/ Values	Description
			<p>is moving (IAS measurement corrected with Standard Atmosphere data)</p> <div style="border-left: 2px solid orange; padding-left: 5px; background-color: #fff9c4;"> <p>Warning Deprecated variable</p> </div>
2	GS (Ground Speed)	m/s	Horizontal speed, relative to the ground
3	Heading	rad	Direction in which the vehicle velocity vector is pointing
4	Flight Path Angle	rad	Angle between velocity vector and local horizontal line
5	Bank	rad	Angle around the Longitudinal Euler axis
6	Yaw	rad	Angle around the Vertical Euler axis
7	Pitch	rad	

ID	Name	Units/ Values	Description
			Angle around the Transverse Euler axis
8	Roll	rad	Angle around the Longitudinal Euler axis
9	Route-Guidance Tangential deviation	m	Tangential distance to the desired position (guidance)
10	Route-Guidance Horizontal deviation	m	Horizontal distance to the desired position (guidance)
11	Route-Guidance Perpendicular deviation	m	Perpendicular distance to the desired position (guidance)
12	p (Angular Velocity - X Body Axis)	rad/s	Angular velocity around longitudinal axis
13	q (Angular Velocity - Y Body Axis)	rad/s	Angular velocity around lateral axis
14	r (Angular Velocity - Z Body Axis)	rad/s	Angular velocity around vertical axis

ID	Name	Units/ Values	Description
15	Forward Acceleration - X Body Axis	m/s ²	Acceleration in the X-axis
16	Right Acceleration - Y Body Axis	m/s ²	Acceleration in the Y-axis
17	Bottom Acceleration - Z Body Axis	m/s ²	Acceleration in the Z-axis
18	RPM	rad/s (RDS)	Revolutions per minute configurable for external sensor
19	Front Ground Velocity	m/s	GV vector X component
20	Lateral Ground Velocity	m/s	GV vector Y component
21	Velocity	m/s	Velocity vector module
22	Forward Load Factor - X Body Axis	customType	G-force in X body axis
23	Right Load Factor - Y Body Axis	customType	G-force in Y body axis

ID	Name	Units/ Values	Description
24	Bottom Load Factor - Z Body Axis	customType	G-force in Z body axis
25	Tangential Acceleration	m/s ²	Absolute acceleration for tangential direction
26	Estimated air density	kg/m ³	Estimated air density at current altitude
27	Gravity at UAV's position	m/s ²	Gravity at UAV's position positive down
28	Co-Yaw	rad	Acrobatic Yaw with Body Z' axis pointing to X
29	Co-Pitch	rad	Acrobatic Pitch with Body X' axis pointing to -Z
30	Co-Roll	rad	Acrobatic Roll with Y' keeping same as Y
31	Angular Acceleration - X Body Axis	rad/s ²	Acceleration around the longitudinal axis

ID	Name	Units/ Values	Description
32	Angular Acceleration - Y Body Axis	rad/s ²	Acceleration around the lateral axis
33	Angular Acceleration - Z Body Axis	rad/s ²	Acceleration around the vertical axis
34	Body to NED Quaternion q _s	customType	First component of body to NED orientation quaternion
35	Body to NED Quaternion q _i	customType	Second component of body to NED orientation quaternion
36	Body to NED Quaternion q _j	customType	Third component of body to NED orientation quaternion
37	Body to NED Quaternion q _k	customType	Fourth component of body to NED orientation quaternion
40	RSSI	percentage	Received Signal Strength Indicator

ID	Name	Units/ Values	Description
			<div style="border-left: 2px solid orange; padding-left: 5px;"> <p>Warning Deprecated variable</p> </div>
42	SCI-A Rx Rate (LTE/EXT. UART)	bytes/s	Reception rate (in bytes per second) of 4G (hwv < 4.7) or external UART (hwv >=4.7) communications
43	SCI-A Tx Rate (LTE/EXT. UART)	bytes/s	Transmission rate (in bytes per second) of 4G (hwv < 4.7) or external UART (hwv >=4.7) communications
44	SCI-B Rx Rate (LOS)	bytes/s	Radio link reception byte rate
45	SCI-B Tx Rate (LOS)	bytes/s	Radio link transmission byte rate
46	SCI-C Rx Rate (RS485)	bytes/s	RS485 communication reception byte rate





ID	Name	Units/ Values	Description
47	SCI-C Tx Rate (RS485)	bytes/s	RS485 communication transmission byte rate
48	SCI-D Rx Rate (RS232)	bytes/s	RS232 communication reception byte rate
49	SCI-D Tx Rate (RS232)	bytes/s	RS232 communication transmission byte rate
50	CAN-A Tx Rate	pkts/s	CAN-A transmission packet rate
51	CAN-B Tx Rate	pkts/s	CAN-B transmission packet rate
52	CAN-A Tx skip Rate	pkts/s	CAN-A messages delayed because no mailbox is available for sending
53	CAN-B Tx skip Rate	pkts/s	CAN-B messages delayed because no mailbox is









ID	Name	Units/ Values	Description
			available for sending
54	CAN-FD-A Tx rate	pkts/s	Transmission frequency of messages for the CAN Flexible Data-rate A interface
55	CAN-FD-A Tx skip rate	pkts/s	Frequency of messages not sent on CAN-FD-A due to full buffers or priority
56	Yaw Rate	rad/s	Rate of change of the yaw angle
57	Pitch Rate	rad/s	Rate of change of the pitch angle
58	Roll Rate	rad/s	Rate of change of the roll angle
59-64	COM 0-5 Parse Error Rate	messages	Each COM discard packages with these frequencies. Messages might be discarded because the calculated and









ID	Name	Units/ Values	Description
			the received CRC are different
65	GNSS Absolute Time Of Week Milliseconds as Unit32	customType	Time of the week expressed with milliseconds
66	GNSS Hours in the Current Day	customType	Elapsed hours in the current day
67	GNSS Minutes in the Current Hour	customType	Elapsed minutes in the current hour
68	GNSS Seconds in the Current Minute	customType	Elapsed seconds in the current minute
70	CAN-A Rx rate	pkts/s	Reception frequency of incoming packets on the CAN-A bus
71	CAN-A Rx skip rate	pkts/s	Frequency of incoming CAN-A messages ignored or dropped by the system
72	CAN-B Rx rate	pkts/s	Reception frequency of



ID	Name	Units/ Values	Description
			incoming packets on the CAN-B bus
73	CAN-B Rx skip rate	pkts/s	Frequency of incoming CAN-B messages ignored or dropped by the system
74	CAN-FD-A Rx rate	pkts/s	Reception frequency of packets for the CAN Flexible Data-rate A interface
75	CAN-FD-A Rx skip rate	pkts/s	Frequency of incoming CAN-FD-A messages ignored or dropped
80	Estimated gyro bias x	rad/s	Gyro bias estimated during IMU calibration
81	Estimated gyro bias y	rad/s	Gyro bias estimated during IMU calibration
82	Estimated gyro bias z	rad/s	Gyro bias estimated during IMU calibration

ID	Name	Units/ Values	Description
83	Estimated accelerometer bias x	m/s ²	Accelerometer bias estimated during IMU calibration
84	Estimated accelerometer bias y	m/s ²	Accelerometer bias estimated during IMU calibration
85	Estimated accelerometer bias z	m/s ²	Accelerometer bias estimated during IMU calibration
90	SCI-E Rx Rate (LTE)	bytes/s	Reception rate (in bytes per seconds) of the first channel (port0) of the SCI expander (hww >=4.7)
91	SCI-E Tx Rate (LTE)	bytes/s	Transmission rate (in bytes per seconds) of the first channel (port0) of the SCI expander (hww >=4.7)
92	SCI-F Rx Rate (LTE Aux.)	bytes/s	Reception rate (in bytes per







ID	Name	Units/ Values	Description
			seconds) of the second channel (port1) of the SCI expander (hww ≥ 4.7)
93	SCI-F Tx Rate (LTE Aux.)	bytes/s	Transmission rate (in bytes per seconds) of the second channel (port1) of the SCI expander (hww ≥ 4.7)
 100	Desired IAS (Indicated Airspeed)	m/s	Commanded IAS from guidance
 101	Desired TAS (True Airspeed)	m/s	Commanded TAS from guidance
 102	Desired GS (Ground Speed)	m/s	Commanded GS from guidance
 103	Desired Heading	rad	Commanded Heading from guidance
 104	Desired Flight Path Angle	rad	Commanded Flight Path Angle from guidance







ID	Name	Units/ Values	Description
 105	Desired Bank	rad	Commanded Bank from guidance
 106	Desired Yaw	rad	Commanded Yaw from guidance
 107	Desired Pitch	rad	Commanded Pitch from guidance
 108	Desired Roll	rad	Commanded Roll from guidance
 112	Desired p (Angular Velocity - X Body Axis)	rad/s	Commanded angular velocity around longitudinal axis
 113	Desired q (Angular Velocity - Y Body Axis)	rad/s	Commanded angular velocity around lateral axis
 114	Desired r (Angular Velocity - Z Body Axis)	rad/s	Commanded angular velocity around vertical axis
 115	Desired Forward Acceleration - X Body Axis	m/s ²	Commanded Forward Acceleration from guidance







ID	Name	Units/ Values	Description
 116	Desired Right Acceleration - Y Body Axis	m/s ²	Commanded Right Acceleration from guidance
 117	Desired Bottom Acceleration - Z Body Axis	m/s ²	Commanded Bottom Acceleration from guidance
 118	Desired RPM	rad/s	Commanded RPM from guidance
 119	Desired Front Ground Velocity	m/s	Commanded Front GV from guidance
 120	Desired Lateral Ground Velocity	m/s	Commanded Lateral GV from guidance
 121	Desired Velocity	m/s	Commanded Velocity from guidance
 122	Desired Forward Load Factor - X Body Axis	customType	Commanded Forward Load Factor from guidance
 123	Desired Right Load Factor - Y Body Axis	customType	Commanded Right Load Factor from guidance

ID	Name	Units/ Values	Description
 124	Desired Bottom Load Factor - Z Body Axis	customType	Commanded Bottom Load Factor from guidance
 125	Desired Tangential Acceleration	m/s ²	Commanded Tangential Acceleration from guidance
 126	Energy Rate Error	customType	Rate of change of the Total System Energy
 127	Energy Distribution Error	customType	Distribution of system energy between kinetical and geopotential energy
 128	Desired Co- Yaw	rad	Commanded co- yaw from guidance
 129	Desired Co- Pitch	rad	Commanded co- pitch from guidance
 130	Desired Co- Roll	rad	Commanded co- roll from guidance
134		rad	Target heading relative to the airflow









ID	Name	Units/ Values	Description
	Desired Aerodynamic Heading		commanded by the guidance system
135	Aerodynamic Heading	rad	Current orientation of the vehicle relative to the wind direction
136	Aerodynamic Heading Error	rad	Difference between the desired and actual aerodynamic heading
137	Desired Aerodynamic Flight Path Angle	rad	Target vertical angle of the flight path relative to the airmass
138	Aerodynamic Flight Path Angle	rad	Actual vertical angle of the velocity vector relative to the airmass
139	Aerodynamic Flight Path Angle Error	rad	Difference between the commanded and actual aerodynamic flight path angle









ID	Name	Units/ Values	Description
 140	Climbing Initial Heading	rad	Heading in climbing phase (start of the route)
 141	Approach Initial Heading	rad	Heading in approach phase (end of the route)
 142	Headwind Direction	rad	Wind direction estimation
 143	Tailwind Direction	rad	Angle of the vector that would correspond to the opposite of the Headwind vector
 144	Runway Direction	rad	Runway angle
 145	Elevation of current route	rad	Elevation of tangent to current route at its closest point to desired position
 146	Azimuth of current route	rad	Azimuth of tangent to current route at its closest point to desired position





ID	Name	Units/ Values	Description
 147	Distance to closest obstacle	m	Signed distance to closest obstacle (negative means inside)
 148	Distance of obstacle repulsion	m	Distance at which the obstacles have an effect in the guidance
 200	Desired North Ground Velocity	m/s	Commanded North (NED Coordinates system) GV from guidance
 201	Desired East Ground Velocity	m/s	Commanded East (NED Coordinates system) GV from guidance
 202	Desired Down Ground Velocity	m/s	Commanded Down (NED Coordinates system) GV from guidance
 203	Desired 2D MSL (Height Above Mean Sea Level)	m	Commanded MSL from guidance in 2D height mode

ID	Name	Units/ Values	Description
 204	Desired 2D AGL (Above Ground Level) - Height	m	Commanded AGL from guidance in 2D height mode
 205	Desired 2D WGS84 Elevation (Height Over The Ellipsoid)	m	Commanded WGS84 Elevation from guidance in 2D height mode
 206	Desired Longitude	rad	Commanded Longitude from guidance
 207	Desired Latitude	rad	Commanded Latitude from guidance
 208	Desired WGS84 Elevation (Height Over The Ellipsoid)	m	Commanded WGS84 Elevation from guidance
 209	Desired MSL (Height Above Mean Sea Level) - Altitude	m	Commanded MSL Altitude from guidance
 210	Desired AGL (Above	m	

ID	Name	Units/ Values	Description
	Ground Level) - Height		Commanded AGL Altitude from guidance
211	Time to Waypoint	seg	Estimated time remaining to reach the next active waypoint
212	Expected North Magnetic Field	T	Predicted North component of the Earth's magnetic field at current UAV position
213	Expected East Magnetic Field	T	Predicted East component of the Earth's magnetic field at current UAV position
214	Expected Down Magnetic Field	T	Predicted vertical (Down) component of the Earth's magnetic field
 250	Guidance North Position Error	m	Difference from Desired and actual north position
		m	Difference from Desired and



ID	Name	Units/ Values	Description
 251	Guidance East Position Error		actual east position
 252	Guidance Down Position Error	m	Difference from Desired and actual down position
 253	Guidance PID North Desired Velocity	m/s	Difference from Desired and actual PID north velocity
 254	Guidance PID East Desired Velocity	m/s	Difference from Desired and actual PID east velocity
 255	Guidance PID Down Desired Velocity	m/s	Difference from Desired and actual PID down velocity
 256	Desired Velocity X Body Axis	m/s	Commanded velocity in X-axis from guidance
 257	Desired Velocity Y Body Axis	m/s	Commanded velocity in Y-axis from guidance
 258	Desired Velocity Z Body Axis	m/s	Commanded velocity in Z-axis from guidance

ID	Name	Units/ Values	Description
 259	External Yaw	rad	Yaw from external navigation source
 260	External Pitch	rad	Pitch from external navigation source
 261	External Roll	rad	Roll from external navigation source
 262	External Roll Rate	rad/s	Roll rate from external navigation source
 263	External Pitch Rate	rad/s	Pitch rate from external navigation source
 264	External Yaw Rate	rad/s	Yaw rate from external navigation source
 265	External Velocity North	m/s	Velocity North from external navigation source
 266	External Velocity East	m/s	Velocity East from external navigation source
 267	External Velocity Down	m/s	Velocity Down from external navigation source

ID	Name	Units/ Values	Description
 268	External Acceleration x Body Axis	m/s ²	Acceleration x body axis from external navigation source
 269	External Acceleration y Body Axis	m/s ²	Acceleration y body axis from external navigation source
 270	External Acceleration z Body Axis	m/s ²	Acceleration z body axis from external navigation source
 271	External GNSS Time of Week	s	GNSS Time of week from external navigation source
300	Relative Timestamp	s	Time spent since power-on of the system
301	Used Memory Space (Deprecated)	byte	SD used memory space Warning Deprecated variable
302		byte	SD free memory space

ID	Name	Units/ Values	Description
	Free Memory Space (Deprecated)		<div style="background-color: #fff9c4; padding: 5px; border: 1px solid #ccc;"> <p style="margin: 0;">Warning Deprecated variable</p> </div>
 303	Dynamic Pressure (Deprecated)	Pa	Physical measurement from Pitot (dynamic pressure) <div style="background-color: #fff9c4; padding: 5px; border: 1px solid #ccc;"> <p style="margin: 0;">Warning Deprecated variable</p> </div>
 304	Static Pressure (Deprecated)	Pa	Physical measurement from Pitot (static pressure) <div style="background-color: #fff9c4; padding: 5px; border: 1px solid #ccc;"> <p style="margin: 0;">Warning Deprecated variable</p> </div>
305	Internal Temperature	K	Physical measurement from internal sensors
307	Accelerometer - X Body Axis	m/s ²	

ID	Name	Units/ Values	Description
			Accelerometer measurement for X axis
308	Accelerometer - Y Body Axis	m/s ²	Accelerometer measurement for Y axis
309	Accelerometer - Z Body Axis	m/s ²	Accelerometer measurement for Z axis
310	Gyroscope - X Body Axis	rad/s	Gyroscope measurement for X axis
311	Gyroscope - Y Body Axis	rad/s	Gyroscope measurement for Y axis
312	Gyroscope - Z Body Axis	rad/s	Gyroscope measurement for Z axis
 313	Magnetometer - X Body Axis	T	Magnetometer measurement for X axis Warning Deprecated variable
		T	

ID	Name	Units/ Values	Description
 314	Magnetometer - Y Body Axis		Magnetometer measurement for Y axis <div style="border-left: 2px solid orange; padding-left: 5px;">Warning Deprecated variable</div>
 315	Magnetometer - Z Body Axis	T	Magnetometer measurement for Z axis <div style="border-left: 2px solid orange; padding-left: 5px;">Warning Deprecated variable</div>
317	ADC 0	volt	Voltage measured at the Analog-to-Digital Converter input channel 0
318	ADC 1	volt	Voltage measured at the Analog-to-Digital Converter input channel 1
319	ADC 2	volt	Voltage measured at the Analog-to-Digital Converter input channel 2
320	ADC 3	volt	

ID	Name	Units/ Values	Description
			Voltage measured at the Analog-to-Digital Converter input channel 3
321	ADC 4	volt	Voltage measured at the Analog-to-Digital Converter input channel 4
322	Magnetometer 0 Raw X in SI	T	Internal 0 Magnetometer raw measurement for X axis
323	Magnetometer 0 Raw Y in SI	T	Internal 0 Magnetometer raw measurement for Y axis
324	Magnetometer 0 Raw Z in SI	T	Internal 0 Magnetometer raw measurement for Z axis
325	Magnetometer 0 Temperature	K	Internal 0 Magnetometer temperature
326	External LIS3MDL Magnetometer Raw X in SI	T	External LIS3MDL Magnetometer

ID	Name	Units/ Values	Description
			raw measurement for X axis
327	External LIS3MDL Magnetometer Raw Y in SI	T	External LIS3MDL Magnetometer raw measurement for Y axis
328	External LIS3MDL magnetometer raw Z in SI	T	External LIS3MDL Magnetometer raw measurement for Z axis
329	External LIS3MDL magnetometer temperature	K	External LIS3MDL Magnetometer temperature
330	IMU 0 Raw Accelerometer X Measurement	m/s ²	IMU 0 raw accelerometer x measurement
331	IMU 0 Raw Accelerometer Y Measurement	m/s ²	IMU 0 raw accelerometer y measurement
332	IMU 0 Raw Accelerometer	m/s ²	IMU 0 raw accelerometer z measurement

ID	Name	Units/ Values	Description
	Z Measurement		
333	IMU 0 Raw Gyroscope X Measurement	rad/s	IMU 0 raw gyroscope x measurement
334	IMU 0 Raw Gyroscope Y Measurement	rad/s	IMU 0 raw gyroscope y measurement
335	IMU 0 Raw Gyroscope Z Measurement	rad/s	IMU 0 raw gyroscope z measurement
336	IMU 0 temperature measurement	K	IMU 0 temperature measurement
337	IMU 1 Raw Accelerometer X Measurement	m/s ²	IMU 1 raw accelerometer x measurement
338	IMU 1 Raw Accelerometer Y Measurement	m/s ²	IMU 1 raw accelerometer y measurement
339	IMU 1 Raw Accelerometer Z Measurement	m/s ²	IMU 1 raw accelerometer z measurement

ID	Name	Units/ Values	Description
340	IMU 1 Raw Gyroscope X Measurement	rad/s	IMU 1 raw gyroscope x measurement
341	IMU 1 Raw Gyroscope Y Measurement	rad/s	IMU 1 raw gyroscope y measurement
342	IMU 1 Raw Gyroscope Z Measurement	rad/s	IMU 1 raw gyroscope z measurement
343	IMU 1 temperature Measurement	K	IMU 1 temperature measurement
344	Static Pressure Sensor 1 Raw Measurement	Pa	Static pressure sensor 1 raw measurement
345	Static Pressure Sensor 1 Temperature	K	Static pressure sensor 1 temperature
346	Dynamic Pressure Sensor Raw Measurement	Pa	Dynamic pressure sensor 1 raw measurement
347	Dynamic Pressure Sensor Temperature	K	Dynamic pressure sensor 1 temperature

ID	Name	Units/ Values	Description
348	Static Pressure Sensor 0 Raw Measurement	Pa	Static pressure sensor 0 raw measurement
349	Static Pressure Sensor 0 Temperature	K	Static pressure sensor 0 temperature
350	Vectornav Message Frequency	Hz	External navigation source VectorNav sends messages with this frequency
351	Vectornav Raw Acc X Measurement	m/s ²	Raw accelerometer X measurement from external navigation source VectorNav
352	Vectornav Raw Acc Y Measurement	m/s ²	Raw accelerometer Y measurement from external navigation source VectorNav
353	Vectornav Raw Acc Z Measurement	m/s ²	Raw accelerometer Z measurement from external

ID	Name	Units/ Values	Description
			navigation source VectorNav
354	Vectornav Raw Gyr X Measurement	rad/s	Raw gyroscope X measurement from external navigation source VectorNav
355	Vectornav Raw Gyr Y Measurement	rad/s	Raw gyroscope Y measurement from external navigation source VectorNav
356	Vectornav Raw Gyr Z Measurement	rad/s	Raw gyroscope Z measurement from external navigation source VectorNav
357	External HSCDTD008A Magnetometer Raw X in SI	T	External HSCDTD008A Magnetometer raw measurement for X axis
358	External HSCDTD008A Magnetometer Raw Y in SI	T	External HSCDTD008A Magnetometer raw measurement for Y axis

ID	Name	Units/ Values	Description
359	External HSCDTD008A Magnetometer Raw Z in SI	T	External HSCDTD008A Magnetometer raw measurement for Z axis
360	External HSCDTD008A Magnetometer Temperature	K	External HSCDTD008A Magnetometer temperature
361	IMU 2 Raw Accelerometer X Measurement	m/s ²	IMU 2 raw accelerometer x measurement
362	IMU 2 Raw Accelerometer Y Measurement	m/s ²	IMU 2 raw accelerometer y measurement
363	IMU 2 Raw Accelerometer Z Measurement	m/s ²	IMU 2 raw accelerometer z measurement
364	IMU 2 Raw Gyroscope X Measurement	rad/s	IMU 2 raw gyroscope x measurement
365	IMU 2 Raw Gyroscope Y Measurement	rad/s	IMU 2 raw gyroscope y measurement

ID	Name	Units/ Values	Description
366	IMU 2 Raw Gyroscope Z Measurement	rad/s	IMU 2 raw gyroscope z measurement
367	IMU 2 Temperature Measurement	K	IMU 2 temperature measurement
368	Static Pressure Sensor 2 Raw Measurement	Pa	Static pressure sensor 2 raw measurement
369	Static Pressure Sensor 2 Temperature	K	Static pressure sensor 2 temperature
370	Magnetometer 1 Raw Measure X Converted to SI	T	Internal 1 Magnetometer raw measurement for X axis converted to SI
371	Magnetometer 1 Raw Measure Y Converted to SI	T	Internal 1 Magnetometer raw measurement for Y axis converted to SI
372	Magnetometer 1 Raw Measure Z Converted to SI	T	Internal 1 Magnetometer raw measurement for Z axis converted to SI

ID	Name	Units/ Values	Description
373	Magnetometer 1 Temperature	K	Internal 1 Magnetometer temperature
374	External Magnetometer MMC5883MA Raw Measure X Converted to SI	T	External MMC5883MA Magnetometer raw measurement for X axis converted to SI
375	External Magnetometer MMC5883MA Raw Measure Y Converted to SI	T	External MMC5883MA Magnetometer raw measurement for Y axis converted to SI
376	External Magnetometer MMC5883MA Raw Measure Z Converted to SI	T	External MMC5883MA Magnetometer raw measurement for Z axis converted to SI
377	External Magnetometer MMC5883MA Temperature	K	External MMC5883MA Magnetometer temperature
378	External Magnetometer RM3100 Raw	T	External RM3100 Magnetometer

ID	Name	Units/ Values	Description
	Measure X Converted to SI		raw measurement for X axis converted to SI
379	External Magnetometer RM3100 Raw Measure Y Converted to SI	T	External RM3100 Magnetometer raw measurement for Y axis converted to SI
380	External Magnetometer RM3100 Raw Measure Z Converted to SI	T	External RM3100 Magnetometer raw measurement for Z axis converted to SI
386	IMU 3 Raw Accelerometer X Measurement	m/s ²	IMU 3 raw accelerometer x measurement
387	IMU 3 Raw Accelerometer Y Measurement	m/s ²	IMU 3 raw accelerometer y measurement
388	IMU 3 Raw Accelerometer Z Measurement	m/s ²	IMU 3 raw accelerometer z measurement

ID	Name	Units/ Values	Description
389	IMU 3 Raw Gyroscope X Measurement	rad/s	IMU 3 raw gyroscope x measurement
390	IMU 3 Raw Gyroscope Y Measurement	rad/s	IMU 3 raw gyroscope y measurement
391	IMU 3 Raw Gyroscope Z Measurement	rad/s	IMU 3 raw gyroscope z measurement
392	IMU 3 Temperature Measurement	K	IMU 3 temperature measurement
393	Magnetometer 2 Raw Measure X Converted to SI	T	Internal 2 Magnetometer raw measurement for X axis converted to SI
394	Magnetometer 2 Raw Measure Y Converted to SI	T	Internal 2 Magnetometer raw measurement for Y axis converted to SI
395	Magnetometer 2 Raw Measure Z Converted to SI	T	Internal 2 Magnetometer raw measurement for Z axis converted to SI

ID	Name	Units/ Values	Description
400	Power Input	V	Voltage received by Veronte
401	Power Comicro 3.3V	V	Voltage received by Veronte through 3.3V port
402	Power 5V	V	Voltage received by Veronte through 5V port
403	SUC Power Input	V	Voltage received by Veronte SUC
404	Power 3.6V	V	Voltage received by Veronte through 3.6V port
405	CPU Temperature	K	Internal computer temperature
406	External IMU 0 raw accelerometer x measurement	m/s ²	Saves the measurements of this external sensor in raw form, as received from the custom messages
407	External IMU 0 raw accelerometer	m/s ²	Saves the measurements of this external sensor in raw form, as received

ID	Name	Units/ Values	Description
	y measurement		from the custom messages
408	External IMU 0 raw accelerometer z measurement	m/s ²	Saves the measurements of this external sensor in raw form, as received from the custom messages
409	External IMU 0 raw gyroscope x measurement	m/s ²	Saves the measurements of this external sensor in raw form, as received from the custom messages
410	External IMU 0 raw gyroscope y measurement	m/s ²	Saves the measurements of this external sensor in raw form, as received from the custom messages
411	External IMU 0 raw gyroscope z measurement	m/s ²	Saves the measurements of this external sensor in raw form, as received

ID	Name	Units/ Values	Description
			from the custom messages
412	External IMU 0 temperature measurement	K	Saves the temperatures of this external sensor in raw form, as received from custom messages
413	External IMU 1 raw accelerometer x measurement	m/s ²	Saves the measurements of this external sensor in raw form, as received from the custom messages
414	External IMU 1 raw accelerometer y measurement	m/s ²	Saves the measurements of this external sensor in raw form, as received from the custom messages
415	External IMU 1 raw accelerometer z measurement	m/s ²	Saves the measurements of this external sensor in raw form, as received

ID	Name	Units/ Values	Description
			from the custom messages
416	External IMU 1 raw gyroscope x measurement	m/s ²	Saves the measurements of this external sensor in raw form, as received from the custom messages
417	External IMU 1 raw gyroscope y measurement	m/s ²	Saves the measurements of this external sensor in raw form, as received from the custom messages
418	External IMU 1 raw gyroscope z measurement	m/s ²	Saves the measurements of this external sensor in raw form, as received from the custom messages
419	External IMU 1 temperature measurement	K	Saves the temperatures of this external sensor in raw form, as received

ID	Name	Units/ Values	Description
			from custom messages
420	External magnetometer 0 raw measurement X	m/s ²	Saves the measurements of this external sensor in raw form, as received from the custom messages
421	External magnetometer 0 raw measurement Y	m/s ²	Saves the measurements of this external sensor in raw form, as received from the custom messages
422	External magnetometer 0 raw measurement Z	m/s ²	Saves the measurements of this external sensor in raw form, as received from the custom messages
423	External magnetometer 0 temperature	K	Saves the temperatures of this external sensor in raw form, as received



ID	Name	Units/ Values	Description
			from custom messages
424	External magnetometer 1 raw measurement X	m/s ²	Saves the measurements of this external sensor in raw form, as received from the custom messages
425	External magnetometer 1 raw measurement Y	m/s ²	Saves the measurements of this external sensor in raw form, as received from the custom messages
426	External magnetometer 1 raw measurement Z	m/s ²	Saves the measurements of this external sensor in raw form, as received from the custom messages
427	External magnetometer 1 temperature	K	Saves the temperatures of this external sensor in raw form, as received



ID	Name	Units/ Values	Description
			from custom messages
428	External navigation yaw	rad	External navigation yaw
429	External navigation pitch	rad	External navigation pitch
430	External navigation roll	rad	External navigation roll
431	External navigation p	rad/s	External navigation p (angular speed in x body axis)
432	External navigation q	rad/s	External navigation q (angular speed in y body axis)
433	External navigation r	rad/s	External navigation r (angular speed in z body axis)
434	External navigation north velocity	m/s	External navigation north velocity
435		m/s	



ID	Name	Units/ Values	Description
	External navigation east velocity		External navigation east velocity
436	External navigation down velocity	m/s	External navigation down velocity
437	External navigation x-body acceleration	m/s ²	External navigation x-body acceleration
438	External navigation y-body acceleration	m/s ²	External navigation y-body acceleration
439	External navigation z-body acceleration	m/s ²	External navigation z-body acceleration
500	Longitude	rad	East-West geographic coordinate
501	Latitude	rad	North-South geographic coordinate
502	WGS84 Elevation	m	Elevation over WGS84 reference frame

ID	Name	Units/ Values	Description
	(Height Over the Ellipsoid)		
503	MSL (Height Above Mean Sea Level) - Altitude	m	Altitude over the Mean Sea Level
504	AGL (Above Ground Level) - Height	m	Height Above Ground Level - Dependent on external sensors or own models with considerable error
505	North Ground Velocity	m/s	Ground Velocity component in the North direction (NED Coordinates system)
506	East Ground Velocity	m/s	Ground Velocity component in the East direction (NED Coordinates system)
507	Down Ground Velocity	m/s	Ground Velocity component in the resultant axis from North-East

ID	Name	Units/ Values	Description
			(NED Coordinates system)
508	Sensor IAS (Indicated Air Speed)	m/s	Pitot-static measurement speed
509	Angle of Attack - AoA	rad	Angle between reference body line and flow direction vector
510	Sideslip	rad	Angle between the flow direction vector and the longitudinal axis of the vehicle
511	GNSS1 MSL	m	Mean sea level (MSL) measurement provided by GPS 1
512	GNSS1 AGL	m	Above ground level (AGL level) measurement provided by GPS 1
513	GNSS2 MSL	m	Mean sea level (MSL) measurement







ID	Name	Units/ Values	Description
			provided by GPS 2
514	GNSS2 AGL	m	Above ground level (AGL level) measurement provided by GPS 2
 551	Sagetech MXS - Longitude decimal part	degree	Sagetech variable, used by block to parse variables for GPS Navigation Data Message <div style="background-color: #fff9c4; padding: 5px; border-left: 2px solid #ffc107;"> <p style="margin: 0;">Warning Variable for internal use</p> </div>
 552	Sagetech MXS - Longitude fractional part	degree	Sagetech variable, used by block to parse variables for GPS Navigation Data Message <div style="background-color: #fff9c4; padding: 5px; border-left: 2px solid #ffc107;"> <p style="margin: 0;">Warning Variable for internal use</p> </div>

ID	Name	Units/ Values	Description
 553	Sagotech MXS - Latitude decimal part	degree	<p>Sagotech variable, used by block to parse variables for GPS Navigation Data Message</p> <div data-bbox="906 703 1203 904" style="background-color: #fff9c4; border-left: 2px solid #ffc107; padding: 5px;"> <p>Warning Variable for internal use</p> </div>
 554	Sagotech MXS - Latitude fractional part	degree	<p>Sagotech variable, used by block to parse variables for GPS Navigation Data Message</p> <div data-bbox="906 1330 1203 1532" style="background-color: #fff9c4; border-left: 2px solid #ffc107; padding: 5px;"> <p>Warning Variable for internal use</p> </div>
 555	Sagotech MXS - Ground speed	m/s	<p>Sagotech variable, used by block to parse variables for GPS Navigation Data Message</p>



ID	Name	Units/ Values	Description
			<p>Warning Variable for internal use</p>
 556	Sagetech MXS - Ground track	degree	<p>Sagetech variable, used by block to parse variables for GPS Navigation Data Message</p> <p>Warning Variable for internal use</p>
 560	ADS-B Out / Squawk	-	<p>ADS-B Squawk code, 4 digits that allow the operator to inform about its status</p>
600-603	Temperature 0-3	K	<p>Variables to be configured with external temperature sensors</p> <p>Warning Deprecated variables</p>

ID	Name	Units/ Values	Description
610	North Position EKF Variance	m ²	North position Extended Kalman Filter variance
611	East Position EKF Variance	m ²	East position Extended Kalman Filter variance
612	Down Position EKF Variance	m ²	Position variance component in the resultant axis from North-East
613	North Velocity EKF Variance	m ² /s ²	North velocity Extended Kalman Filter variance
614	East Velocity EKF Variance	m ² /s ²	East velocity Extended Kalman Filter variance
615	Down Velocity EKF Variance	m ² /s ²	Velocity variance component in the resultant axis from North-East
616	North Misalignment EKF Variance	rad ²	North misalignment Extended Kalman Filter variance
617		rad ²	East misalignment







ID	Name	Units/ Values	Description
	East Misalignment EKF Variance		Extended Kalman Filter variance
618	Down Misalignment EKF Variance	rad ²	Down misalignment Extended Kalman Filter variance
619	X Body Gyroscope Bias EKF Variance	rad ² /s ²	X body gyroscope bias Extended Kalman Filter variance
620	Y Body Gyroscope Bias EKF Variance	rad ² /s ²	Y body gyroscope bias Extended Kalman Filter variance
621	Z Body Gyroscope Bias EKF Variance	rad ² /s ²	Z body gyroscope bias Extended Kalman Filter variance
622	X Body Accelerometer Bias EKF Variance	m ² /s ⁴	X body accelerometer bias Extended Kalman Filter variance
623	Y Body Accelerometer	m ² /s ⁴	Y body accelerometer bias Extended



ID	Name	Units/ Values	Description
	Bias EKF Variance		Kalman Filter variance
624	Z Body Accelerometer Bias EKF Variance	m^2/s^4	Z body accelerometer bias Extended Kalman Filter variance
 650	Gimbal Command Yaw	customType	Yaw sent to the gimbal
 651	Gimbal Command Pitch	customType	Pitch sent to the gimbal
 652	Gimbal Stick Yaw	customType	Yaw received from the joystick controlling the gimbal
 653	Gimbal Stick Pitch	customType	Pitch received from the joystick controlling the gimbal
 654	Gimbal Pitch Correction 0	customType	Correction calculated by the gimbal for the pitch control 0
 655	Gimbal Pitch Correction 1	customType	Correction calculated by the

ID	Name	Units/ Values	Description
			gimbal for the pitch control 1
 656	Gimbal Old Joint 0	customType	Auxiliar variable 0 for Gimbal control configuration
 657	Gimbal Old Joint 1	customType	Auxiliar variable 1 for Gimbal control configuration
 658	Cos (Gimbal Yaw)	customType	Auxiliar variable 0 for Gimbal control configuration
 659	Sin (Gimbal Yaw)	customType	Auxiliar variable 1 for Gimbal control configuration
 660	Gimbal Yaw Radian	customType	Auxiliar variable for Gimbal control configuration
 661	Veronte Gimbal Yaw Output	customType	Yaw value the gimbal is sending as output
 662	Veronte Gimbal Pitch Output	customType	Pitch value the gimbal is sending as output
 663	Gimbal Phi(z)	customType	Auxiliar variable phi for Gimbal

ID	Name	Units/ Values	Description
			control configuration
 664	Gimbal Theta(y)	customType	Auxiliar variable theta for Gimbal control configuration
 665	Gimbal Psi(x)	customType	Auxiliar variable psi for Gimbal control configuration
 666	Veronte Gimbal Roll Output (Degrees)	customType	Roll value the gimbal is sending as output
700-705	RPM 0-5	rad/s	Angular speed associated to pulse captured 0-5
750	Selected Controller Time Step	s	PID selected time step
751	Selected Controller Derivative Filtered Error	customType	PID selected derivative filtered error
752	Selected Controller	customType	

ID	Name	Units/ Values	Description
	Proportional Action		PID selected proportional action
753	Selected Controller Derivative Action	customType	PID selected derivative action
754	Selected Controller Integral Input	customType	PID selected integral input
755	Selected Controller Integral Action	customType	PID selected integral action
756	Selected Controller Anti-windup Input	customType	PID selected anti-windup input
757	Selected Controller Derivative Error	customType	PID selected derivative error
800-823	PWM 0-23	customType	Pulse Width Modulation signal 0-23
 900-915	Stick Input r0 - r15	customType	Raw stick measurement r0-r15

ID	Name	Units/ Values	Description
 950-981	Stick Input s0 - s31	customType	Warning Deprecated variables
 1000-1031	Stick Input y0 - y31	customType	Servo position commanded stick y0-y31
 1050-1069	Control Output u0-u19 Before Servo Saturation	customType	Commanded control output before saturation correction
 1100-1104	Lidar 0-4 Distance	m	Variable configurable for Lidar distances 0-4
 1105-1109	External Range Sensor 0-4 Measure	m	Variable configurable for external range sensors
 1200	Route- Guidance Distance	m	Shortest distance to desired path (perpendicular distance)
 1201	Radar AGL (Above Ground Level) - Height	m	Radar altimeter measure

ID	Name	Units/ Values	Description
 1202	Radar Speed Down	m/s	Radar speed
 1203	External Rotation for Follow Route	rad	Relative vector rotation when using Follow Route
1204	Time to Impact with Obstacles	s	Time calculated with Distance to Obstacle and travel speed
1300-1309	Timer 0-9	s	Configurable timers for automations
1320-1321	CEX/MEX ADC 3.3V Input 0-1	V	CEX/MEX ADC 3.3 V inputs 0 and 1
1322-1323	CEX/MEX ADC 5.0V Input 0-1	V	CEX/MEX ADC 5.0 V inputs 0 and 1
1324-1325	CEX/MEX ADC 12.0V Input 0-1	V	CEX/MEX ADC 12.0 V inputs 0 and 1
1326-1327	CEX/MEX ADC 36.0V Input 0-1	V	CEX/MEX ADC 36.0 V inputs 0 and 1
1328-1329	CEX/MEX ADC vIn 0-1	V	

ID	Name	Units/ Values	Description
			CEX/MEX External power supplies 0 and 1
1330	CEX/MEX PCB Temperature	K	CEX/MEX PCB Temperature (from ADC input)
1331	CEX/MEX ADC HW Version	V	Hardware version of CEX/MEX ADC
 1350-1369	4X Real variables	-	For more information, check Real Variables - 4x Software Manual
1400	Velocity - X Body Axis	m/s	Velocity on X-axis
1401	Velocity - Y Body Axis	m/s	Velocity on Y-axis
1402	Velocity - Z Body Axis	m/s	Velocity on Z-axis
1403	Estimated Dynamic Pressure	Pa	Dynamic pressure sensor raw measurement
1404	Barometric Pressure at	Pa	Introduced value for QNH

ID	Name	Units/ Values	Description
	Sea Level (QNH)		
1450-1453	Captured Pulse 0-3	customType	Input values from pulses
1483	External navigation sensor frequency	Hz	External navigation sensor frequency
1484	External IMU 0 accelerometer reception frequency	Hz	Reception frequencies of measurements from External IMU 0 accelerometer
1485	External IMU 0 gyroscope reception frequency	Hz	Reception frequencies of measurements from External IMU 0 gyroscope
1486	External IMU 1 accelerometer reception frequency	Hz	Reception frequencies of measurements from External IMU 1 accelerometer
1487	External IMU 1 gyroscope reception frequency	Hz	Reception frequencies of measurements

ID	Name	Units/ Values	Description
			from External IMU 1 gyroscope
1488-1489	External magnetometer 0-1 reception frequency	Hz	Reception frequencies of measurements from External magnetometer 0-1
1490	Interneet Raw X Distance	m	Raw measurements for X-axis interneet distance
1491	Interneet Raw Y Distance	m	Raw measurements for Y-axis interneet distance
1492	Interneet Raw Z Distance	m	Raw measurements for Z-axis interneet distance
1493	Interneet Raw Angle	rad	Raw measurements for interneet angle
1494	Interneet Raw XY standard Deviation	m	Raw measurements for XY axis interneet

ID	Name	Units/ Values	Description
			standard deviation
1495	Interneest Raw Z standard Deviation	m	Raw measurements for Z-axis interneest standard deviation
1496	Interneest Raw Angle standard Deviation	rad	Raw measurements for interneest angle standard deviation
1497	Interneest Position Update Frequency	Hz	Frequency to update interneest position
1500	GNSS1 Absolute Time of Week	s	Data from GNSS1 module: Time of week
1501	GNSS1 ECEF Position X	m	Data from GNSS1 module: ECEF (Earth-Centered Earth-Fixed coordinate system) X position

ID	Name	Units/ Values	Description
1502	GNSS1 ECEF Position Y	m	Data from GNSS1 module: ECEF (Earth-Centered Earth-Fixed coordinate system) Y position
1503	GNSS1 ECEF Position Z	m	Data from GNSS1 module: ECEF (Earth-Centered Earth-Fixed coordinate system) Z position
1504	GNSS1 Longitude	rad	Data from GNSS1 module: Longitude
1505	GNSS1 Latitude	rad	Data from GNSS1 module: Latitude
1506	GNSS1 Height Above Ellipsoid (WGS84)	m	Data from GNSS1 module: Height Above Ellipsoid (WGS84)
1509	GNSS1 PDOP (Dilution of Precision of Position)	customType	Data from GNSS1 module: PDOP - Relation between user position

ID	Name	Units/ Values	Description
			error and satellite position error
1510	GNSS1 Accuracy	m	Data from GNSS1 module: Accuracy
1511	GNSS1 Horizontal Accuracy Estimate	m	Data from GNSS1 module: Horizontal accuracy
1512	GNSS1 Vertical Accuracy Estimate	m	Data from GNSS1 module: Vertical accuracy
1513	GNSS1 Velocity North	m/s	Data from GNSS1 module: Velocity in North direction (NED Coordinates system)
1514	GNSS1 Velocity East	m/s	Data from GNSS1 module: Velocity in East direction (NED Coordinates system)
1515	GNSS1 Velocity Down	m/s	Data from GNSS1 module: Velocity in Down direction (NED Coordinates system)

ID	Name	Units/ Values	Description
1516	GNSS1 Speed Accuracy Estimate	m/s	Data from GNSS1 module: Speed accuracy
1517	GNSS1 Related Base Longitude	rad	Data from GNSS1 module: RTK Base longitude
1518	GNSS1 Related Base Latitude	rad	Data from GNSS1 module: RTK Base latitude
1519	GNSS1 Related Base WGS84 Altitude	m	Data from GNSS1 module: RTK Base WGS84 altitude
1520	GNSS1 Related Base to Rover Azimuth	rad	Data from GNSS1 module: RTK Base-Rover vector azimuth (Spherical coordinates system)
1521	GNSS1 Related Base to Rover Elevation	rad	Data from GNSS1 module: RTK Base-Rover vector elevation (Spherical coordinates system)

ID	Name	Units/ Values	Description
1522	GNSS1 Related Base to Rover Distance	m	Data from GNSS1 module: RTK Base-Rover vector distance (Spherical coordinates system)
1523	GNSS1 Related Base to Rover Accuracy	m	Data from GNSS1 module: RTK Base-Rover vector accuracy
1524	GNSS1 Survey in Accuracy	m	Data from GNSS1 module: RTK Base accuracy when base knows it is fixed in a particular position
1525	GNSS1 Related Base to Rover North	m	Data from GNSS1 module: RTK Base-Rover vector North (NED Coordinate system)
1526	GNSS1 Related Base to Rover East	m	Data from GNSS1 module: RTK Base-Rover vector East (NED Coordinate system)





ID	Name	Units/ Values	Description
1527	GNSS1 Related Base to Rover Down	m	Data from GNSS1 module: RTK Base-Rover vector Down (NED Coordinate system)
1528	GNSS1 Position Frequency	Hz	Data from GNSS1 module: Position frequency
1529	GNSS1 Jamming Indicator	%	Jamming indicator from U-Blox device 1 for GNSS
1600	GNSS2 Absolute Time of Week	s	Data from GNSS2 module: Time of week
1601	GNSS2 ECEF Position X	m	Data from GNSS2 module: ECEF (Earth-Centered Earth-Fixed coordinate system) X position
1602	GNSS2 ECEF Position Y	m	Data from GNSS2 module: ECEF (Earth-Centered Earth-Fixed coordinate







ID	Name	Units/ Values	Description
			system) Y position
1603	GNSS2 ECEF Position Z	m	Data from GNSS2 module: ECEF (Earth-Centered Earth-Fixed coordinate system) Z position
1604	GNSS2 Longitude	rad	Data from GNSS2 module: Longitude
1605	GNSS2 Latitude	rad	Data from GNSS2 module: Latitude
1606	GNSS2 Height Above Ellipsoid (WGS84)	m	Data from GNSS2 module: Height Above Ellipsoid (WGS84)
1609	GNSS2 PDOP (Dilution of Precision of Position)	customType	Data from GNSS2 module: PDOP - Relation between user position error and satellite position error
1610	GNSS2 Accuracy	m	Data from GNSS2 module: Accuracy
1611		m	







ID	Name	Units/ Values	Description
	GNSS2 Horizontal Accuracy Estimate		Data from GNSS2 module: Horizontal accuracy
1612	GNSS2 Vertical Accuracy Estimate	m	Data from GNSS2 module: Vertical accuracy
1613	GNSS2 Velocity North	m/s	Data from GNSS2 module: Velocity in North direction (NED Coordinates system)
1614	GNSS2 Velocity East	m/s	Data from GNSS2 module: Velocity in East direction (NED Coordinates system)
1615	GNSS2 Velocity Down	m/s	Data from GNSS2 module: Velocity in Down direction (NED Coordinates system)
1616	GNSS2 Speed Accuracy Estimate	m/s	Data from GNSS2 module: Speed accuracy
1617		rad	







ID	Name	Units/ Values	Description
	GNSS2 Related Base Longitude		Data from GNSS2 module: RTK Base longitude
1618	GNSS2 Related Base Latitude	rad	Data from GNSS2 module: RTK Base latitude
1619	GNSS2 Related Base WGS84 Altitude	m	Data from GNSS2 module: RTK Base WGS84 Altitude
1620	GNSS2 Related Base to Rover Azimuth	rad	Data from GNSS2 module: RTK Base-Rover vector azimuth (Spherical Coordinates system)
1621	GNSS2 Related Base to Rover Elevation	rad	Data from GNSS2 module: RTK Base-Rover vector elevation (Spherical Coordinates system)
1622	GNSS2 Related Base to Rover Distance	m	Data from GNSS2 module: RTK Base-Rover vector distance (Spherical







ID	Name	Units/ Values	Description
			Coordinates system)
1623	GNSS2 Related Base to Rover Accuracy	m	Data from GNSS2 module: RTK Base-Rover vector accuracy
1624	GNSS2 Survey in Accuracy	m	Data from GNSS2 module: RTK Base accuracy when base knows it is fixed in a particular position
1625	GNSS2 Related Base to Rover North	m	Data from GNSS2 module: RTK Base-Rover vector North (NED Coordinate system)
1626	GNSS2 Related Base to Rover East	m	Data from GNSS2 module: RTK Base-Rover vector East (NED Coordinate system)
1627	GNSS2 Related Base to Rover Down	m	Data from GNSS2 module: RTK Base-Rover vector Down (NED







ID	Name	Units/ Values	Description
			Coordinate system)
1628	GNSS2 Position Frequency	H	Data from GNSS2 module: Position frequency
1629	GNSS2 Jamming Indicator	%	Jamming indicator from U-Blox device 2 for GNSS
 1700-1731	Actuator Output s0 - s31	customType	Configurable variable from actuator outputs to be transformed by the system
1771	Commanded PDS	customType	PWM command signal for the Power Distribution System actuators
 1800	Distance to Object of Interest 0	m	Spherical coordinate to object of interest 0: distance
 1801	Azimuth to Object of Interest 0	rad	Spherical coordinate to object of interest 0: azimuth
 1802		rad	Spherical coordinate to







ID	Name	Units/ Values	Description
	Elevation to Object of Interest 0		object of interest 0: elevation
 1803	Distance to Object of Interest 1	m	Spherical coordinate to object of interest 1: distance
 1804	Azimuth to Object of Interest 1	rad	Spherical coordinate to object of interest 1: azimuth
 1805	Elevation to Object of Interest 1	rad	Spherical coordinate to object of interest 1: elevation
 1806	Distance to Object of Interest 2	m	Spherical coordinate to object of interest 2: distance
 1807	Azimuth to Object of Interest 2	rad	Spherical coordinate to object of interest 2: azimuth
 1808	Elevation to Object of Interest 2	rad	Spherical coordinate to object of interest 2: elevation







ID	Name	Units/ Values	Description
 1809	Distance to Object of Interest 3	m	Spherical coordinate to object of interest 3: distance
 1810	Azimuth to Object of Interest 3	rad	Spherical coordinate to object of interest 3: azimuth
 1811	Elevation to Object of Interest 3	rad	Spherical coordinate to object of interest 3: elevation
 1812	Distance to Object of Interest 4	m	Spherical coordinate to object of interest 4: distance
 1813	Azimuth to Object of Interest 4	rad	Spherical coordinate to object of interest 4: azimuth
 1814	Elevation to Object of Interest 4	rad	Spherical coordinate to object of interest 4: elevation
 1815	Distance to Object of Interest 5	m	Spherical coordinate to







ID	Name	Units/ Values	Description
			object of interest 5: distance
 1816	Azimuth to Object of Interest 5	rad	Spherical coordinate to object of interest 5: azimuth
 1817	Elevation to Object of Interest 5	rad	Spherical coordinate to object of interest 5: elevation
 1818	Distance to Object of Interest 6	m	Spherical coordinate to object of interest 6: distance
 1819	Azimuth to Object of Interest 6	rad	Spherical coordinate to object of interest 6: azimuth
 1820	Elevation to Object of Interest 6	rad	Spherical coordinate to object of interest 6: elevation
 1821	Distance to Object of Interest 7	m	Spherical coordinate to object of interest 7: distance
		rad	







ID	Name	Units/ Values	Description
 1822	Azimuth to Object of Interest 7		Spherical coordinate to object of interest 7: azimuth
 1823	Elevation to Object of Interest 7	rad	Spherical coordinate to object of interest 7: elevation
 1824	Distance to Object of Interest 8	m	Spherical coordinate to object of interest 8: distance
 1825	Azimuth to Object of Interest 8	rad	Spherical coordinate to object of interest 8: azimuth
 1826	Elevation to Object of Interest 8	rad	Spherical coordinate to object of interest 8: elevation
 1827	Distance to Object of Interest 9	m	Spherical coordinate to object of interest 9: distance
 1828	Azimuth to Object of Interest 9	rad	Spherical coordinate to







ID	Name	Units/ Values	Description
			object of interest 9: azimuth
 1829	Elevation to Object of Interest 9	rad	Spherical coordinate to object of interest 9: elevation
 1830	Distance to Object of Interest 10	m	Spherical coordinate to object of interest 10: distance
 1831	Azimuth to Object of Interest 10	rad	Spherical coordinate to object of interest 10: azimuth
 1832	Elevation to Object of Interest 10	rad	Spherical coordinate to object of interest 10: elevation
 1833	Distance to Object of Interest 11	m	Spherical coordinate to object of interest 11: distance
 1834	Azimuth to Object of Interest 11	rad	Spherical coordinate to object of interest 11: azimuth
		rad	







ID	Name	Units/ Values	Description
 1835	Elevation to Object of Interest 11		Spherical coordinate to object of interest 11: elevation
 1836	Distance to Object of Interest 12	m	Spherical coordinate to object of interest 12: distance
 1837	Azimuth to Object of Interest 12	rad	Spherical coordinate to object of interest 12: azimuth
 1838	Elevation to Object of Interest 12	rad	Spherical coordinate to object of interest 12: elevation
 1839	Distance to Object of Interest 13	m	Spherical coordinate to object of interest 13: distance
 1840	Azimuth to Object of Interest 13	rad	Spherical coordinate to object of interest 13: azimuth
 1841	Elevation to Object of Interest 13	rad	Spherical coordinate to







ID	Name	Units/ Values	Description
			object of interest 13: elevation
 1842	Distance to Object of Interest 14	m	Spherical coordinate to object of interest 14: distance
 1843	Azimuth to Object of Interest 14	rad	Spherical coordinate to object of interest 14: azimuth
 1844	Elevation to Object of Interest 14	rad	Spherical coordinate to object of interest 14: elevation
 1845	Distance to Object of Interest 15	m	Spherical coordinate to object of interest 15: distance
 1846	Azimuth to Object of Interest 15	rad	Spherical coordinate to object of interest 15: azimuth
 1847	Elevation to Object of Interest 15	rad	Spherical coordinate to object of interest 15: elevation
		m	







ID	Name	Units/ Values	Description
 1848	Distance to Object of Interest 16		Spherical coordinate to object of interest 16: distance
 1849	Azimuth to Object of Interest 16	rad	Spherical coordinate to object of interest 16: azimuth
 1850	Elevation to Object of Interest 16	rad	Spherical coordinate to object of interest 16: elevation
 1851	Distance to Object of Interest 17	m	Spherical coordinate to object of interest 17: distance
 1852	Azimuth to Object of Interest 17	rad	Spherical coordinate to object of interest 17: azimuth
 1853	Elevation to Object of Interest 17	rad	Spherical coordinate to object of interest 17: elevation
 1854	Distance to Object of Interest 18	m	Spherical coordinate to







ID	Name	Units/ Values	Description
			object of interest 18: distance
 1855	Azimuth to Object of Interest 18	rad	Spherical coordinate to object of interest 18: azimuth
 1856	Elevation to Object of Interest 18	rad	Spherical coordinate to object of interest 18: elevation
 1857	Distance to Object of Interest 19	m	Spherical coordinate to object of interest 19: distance
 1858	Azimuth to Object of Interest 19	rad	Spherical coordinate to object of interest 19: azimuth
 1859	Elevation to Object of Interest 19	rad	Spherical coordinate to object of interest 19: elevation
 1860	Distance to Object of Interest 20	m	Spherical coordinate to object of interest 20: distance
		rad	



ID	Name	Units/ Values	Description
 1861	Azimuth to Object of Interest 20		Spherical coordinate to object of interest 20: azimuth
 1862	Elevation to Object of Interest 20	rad	Spherical coordinate to object of interest 20: elevation
 1863	Distance to Object of Interest 21	m	Spherical coordinate to object of interest 21: distance
 1864	Azimuth to Object of Interest 21	rad	Spherical coordinate to object of interest 21: azimuth
 1865	Elevation to Object of Interest 21	rad	Spherical coordinate to object of interest 21: elevation
 1866	Distance to Object of Interest 22	m	Spherical coordinate to object of interest 22: distance
 1867	Azimuth to Object of Interest 22	rad	Spherical coordinate to

ID	Name	Units/ Values	Description
			object of interest 22: azimuth
 1868	Elevation to Object of Interest 22	rad	Spherical coordinate to object of interest 22: elevation
 1869	Distance to Object of Interest 23	m	Spherical coordinate to object of interest 23: distance
 1870	Azimuth to Object of Interest 23	rad	Spherical coordinate to object of interest 23: azimuth
 1871	Elevation to Object of Interest 23	rad	Spherical coordinate to object of interest 23: elevation
 1872	Distance to Object of Interest 24	m	Spherical coordinate to object of interest 24: distance
 1873	Azimuth to Object of Interest 24	rad	Spherical coordinate to object of interest 24: azimuth
		rad	

ID	Name	Units/ Values	Description
 1874	Elevation to Object of Interest 24		Spherical coordinate to object of interest 24: elevation
 1875	Distance to Object of Interest 25	m	Spherical coordinate to object of interest 25: distance
 1876	Azimuth to Object of Interest 25	rad	Spherical coordinate to object of interest 25: azimuth
 1877	Elevation to Object of Interest 25	rad	Spherical coordinate to object of interest 25: elevation
 1878	Distance to Object of Interest 26	m	Spherical coordinate to object of interest 26: distance
 1879	Azimuth to Object of Interest 26	rad	Spherical coordinate to object of interest 26: azimuth
 1880	Elevation to Object of Interest 26	rad	Spherical coordinate to

ID	Name	Units/ Values	Description
			object of interest 26: elevation
 1881	Distance to Object of Interest 27	m	Spherical coordinate to object of interest 27: distance
 1882	Azimuth to Object of Interest 27	rad	Spherical coordinate to object of interest 27: azimuth
 1883	Elevation to Object of Interest 27	rad	Spherical coordinate to object of interest 27: elevation
 1884	Distance to Object of Interest 28	m	Spherical coordinate to object of interest 28: distance
 1885	Azimuth to Object of Interest 28	rad	Spherical coordinate to object of interest 28: azimuth
 1886	Elevation to Object of Interest 28	rad	Spherical coordinate to object of interest 28: elevation
		m	

ID	Name	Units/ Values	Description
 1887	Distance to Object of Interest 29		Spherical coordinate to object of interest 29: distance
 1888	Azimuth to Object of Interest 29	rad	Spherical coordinate to object of interest 29: azimuth
 1889	Elevation to Object of Interest 29	rad	Spherical coordinate to object of interest 29: elevation
 1890	Distance to Object of Interest 30	m	Spherical coordinate to object of interest 30: distance
 1891	Azimuth to Object of Interest 30	rad	Spherical coordinate to object of interest 30: azimuth
 1892	Elevation to Object of Interest 30	rad	Spherical coordinate to object of interest 30: elevation
 1893	Distance to Object of Interest 31	m	Spherical coordinate to

ID	Name	Units/ Values	Description
			object of interest 31: distance
 1894	Azimuth to Object of Interest 31	rad	Spherical coordinate to object of interest 31: azimuth
 1895	Elevation to Object of Interest 31	rad	Spherical coordinate to object of interest 31: elevation
2000	RX Packet Error Rate (on board)	decimal	Value rating RX packets and expected RX packets, given as % error
2001	TX Packet Error Rate (on board)	decimal	Value rating TX packets and expected TX packets, given as % error
2002	Computed RX pkt/s Used for RX PER	messages	Packages per second received to the UAV configured in communication statistics
2003		messages	RX packages per second received

ID	Name	Units/ Values	Description
	Remote RX pkt/s Used for TX PER		and computed through communications
2004	Computed TX pkt/s Used for TX PER	messages	Packages per second transmitted to the UAV configured in communication statistics
2005	Remote TX pkt/s Used for RX PER	messages	TX packages per second received and computed through communications
 2019	Stick RX Rate	Hz	Number of stick messages received per second
2020	Position Fix Time	s	Time spend with GNSS without losing fix
2040-2042	Tunnel Producer Receive Frequency 0-2	Hz	Tunnel producer 0-2 receives data at this frequency
2043-2045	Tunnel Consumer	Hz	



ID	Name	Units/ Values	Description
	Send Frequency 0-2		Tunnel consumer 0-2 receives data at this frequency
2046	Max Duration of Step in CIO	s	Longest time duration from a step in CIO
2047	Acquisition Task Timestep	s	Average period to execute the acquisition thread
2048	Acquisition Task Maximum Timestep	s	Maximum period to execute the acquisition thread
2049	Cross Core Message Queue CPU Ratio	percentage	% of time of CPU that CIO waits for inter-core communications queue to be emptied
2050	Acquisition Task Average CPU Ratio	percentage	Average % of CPU time spent in the acquisition thread
2051	Acquisition Task Maximum CPU Ratio	percentage	Maximum % of CPU time spent in the acquisition thread
2052		s	Average time for acquisition thread









ID	Name	Units/ Values	Description
	Acquisition Task Average Time		
2053	Acquisition Task Maximum Time	s	Maximum time for acquisition thread
2054	CIO Max Time	s	Maximum time of CIO thread
2055	CIO Average Time	s	Average and Maximum time of CIO thread
2056	Cross-Core Message Queue Usage	%	Percentage of communication employed between both microprocessors
2057	CIO Running Frequency	Hz	C1 low running frequency
2058	MC CIO Min Running Frequency	Hz	Minimum assured frequency of low priority task Note Only for MC
2092	CPU2 Low priority	Hz	Current running frequency of the









ID	Name	Units/ Values	Description
	current frequency		CPU2 low priority tasks
2093	CPU2 Low priority min frequency	Hz	Minimum recorded frequency of the CPU2 low priority tasks
2094	GNC Task Average CPU Ratio	percentage	Average % of CPU time of GNC task
2095	GNC Task Maximum CPU Ratio	percentage	Maximum % of CPU time of GNC task
2096	GNC Task Average Time	s	Average time spent on GNC task
2097	GNC Task Maximum Time	s	Maximum time spent on GNC task
2098	GNC Task Maximum Timestep	s	Maximum execution period for GNC task
2099	Max Duration of Step in GNC	s	Maximum duration of one step in GNC
2100		rad/s	







ID	Name	Units/ Values	Description
	Gyroscope Based on Accelerometer - X Body Axis		Gyroscope measurements obtained from accelerometer X- axis data
2101	Gyroscope Based on Accelerometer - Y Body Axis	rad/s	Gyroscope measurements obtained from accelerometer Y- axis data
2102	Gyroscope Based on Accelerometer - Z Body Axis	rad/s	Gyroscope measurements obtained from accelerometer Z- axis data
2103	Acceleration North	m/s ²	Acceleration in the North direction (NED Coordinates System)
2104	Acceleration East	m/s ²	Acceleration in the East direction (NED Coordinates System)
2105	Acceleration Down	m/s ²	Acceleration in the Down direction (NED









ID	Name	Units/ Values	Description
			Coordinates System)
2112	Estimated Dem	m	Altitude given by the estimated Digital Elevation Model
2200	Curve Length Covered	m	Total distance from current mission length covered
2201	Curve Length	m	Total distance from current mission length
2202	Curve Length Pending	m	Total distance from current mission length not covered yet
2203	Curve Parameter Covered	customType	Total length covered from current mission according to parameter selected
2204	Curve Parameter Range	customType	Total length from current mission according to









ID	Name	Units/ Values	Description
			parameter selected
2205	Curve Parameter Pending	customType	Total length from current mission to be covered according to parameter selected yet
2206	Curve Horizontal Curvature	customType	Horizontal curvature of the current curve
 2300-2302	Joint 0-2 of Gimbal 0	rad	Variables for Gimbal 0 configuration - Angles sent to gimbal as Yaw (0), Pitch (1) and Roll (2)
 2303-2305	Joint 0-2 of Gimbal 1	rad	Variables for Gimbal 1 configuration - Angles sent to gimbal as Yaw (0), Pitch (1) and Roll (2)
 2330	Control Loop Period	s	MC control loop period







ID	Name	Units/ Values	Description
 2331	Control Loop Maximum Period	s	MC maximum control loop period
 2332	Control Loop Duration	s	MC control loop average execution time
 2333	MC Control Loop Maximum Duration	s	MC control loop maximum average execution time
 2334	Control Loop CPU Usage Ratio	%	CPU usage ratio
 2335	MC Control Loop Maximum CPU Usage Ratio	%	MC maximum CPU usage ratio
 2336-2338	MC U-V-W Phase Current	A	MC U-V-W phase current
 2339	MC Electrical Angle	rad	MC electrical angle
 2340	MC01 Mechanical Angle	rad	MC01 mechanical angle
		rad/s	





ID	Name	Units/ Values	Description
 2341	MC Mechanical Angular Speed		MC mechanical angular speed
 2342	MC01 Desired Mechanical Angle	rad	MC01 desired mechanical angle
 2343	MC01 Position Controller Output	rad/s	MC01 position PDI output
 2344	MC Desired Mechanical Angular Speed	rad/s	MC desired mechanical angular speed
 2345	MC Desired Mechanical Angular Speed After Speed Limiter	rad/s	MC desired mechanical angular speed after speed limiter
 2346	MC Speed Controller Output	A	MC speed controller output
 2347-2348	MC Alpha-Beta Current	A	MC alpha and beta current after Clarke transformation
 2349-2350	MC Actual Direct Current	A	MC actual direct current



ID	Name	Units/ Values	Description
 2351	MC Desired Direct Current	A	MC desired direct current
 2352	MC Desired Quadrature Current	A	MC desired quadrature current
 2353	MC Direct Voltage From Controller Output	V	MC direct voltage from controller output
 2354	MC Quadrature Voltage From Controller Output	V	MC quadrature voltage from controller output
 2355-2356	MC Alpha - Beta Voltage From Current Controller Output	V	MC Alpha - Beta voltage from current controller output
 2357-2358	MC01 Desired Clarke Alpha-Beta current	customType	MC01 desired Clarke currents
 2359-2361	MC01 U-V-W Phase Space Vector Generator Output	customType	MC01 phase time constants





ID	Name	Units/ Values	Description
 2362-2364	MC U-V-W Phase PWM Duty Cycle	percentage	MC U-V-W Phase PWM duty cycle
 2365	MC01 Encoder Raw Angle	rad	MC01 encoder raw measured angle
 2366	MC01 Stepper Output Frequency	Hz	MC01 stepper output frequency
 2367	MC Mechanical Angle Error	rad	MC mechanical angle error
 2368-2370	MC U-V-W Phase BEMF	V	MC U-V-W phase electromechanical force
 2371	MC Input Current DC side	A	MC input current DC side
 2372	MC Input Normalized Command Speed	customType	MC input normalized command speed
 2373-2374	MC ADC in 0-1	V	System reserved variables
		K	

ID	Name	Units/ Values	Description
 2375	MC Logic Board Temperature		MC logic board temperature
 2376	MC Power Module Temperature	K	MC IGBT filtered temperature
 2377	MC Motor Temperature	K	MC Motor temperature
 2378	MC Input Voltage DC side	V	MC DC bus voltage
 2379-2380	MC U-V Phase Hall current sensor	customType	System reserved variables
 2381	MC Virtual and estimator angle difference	rad	MC Angle offset value from estimated and commanded angle to close control loop
 2382	MC Low speed estimator angle	rad	MC Low speed observer estimated angle
 2383	MC High speed estimator angle	rad	MC High speed observer estimated angle

ID	Name	Units/ Values	Description
 2384	MC Low speed estimator speed	rad/s	MC Low speed observer estimated mechanical speed
 2385	MC High speed estimator speed	rad/s	MC High speed observer estimated mechanical speed
2386	String DC current	A	Direct current measured in the motor string/ power line
 2400-2419	Control Output u0-19	customType	Control output 0-19 after servo saturation
 2450-2469	Inner Controller Output 0-19	customType	Inner controller output 0-19
 2500-2519	Stick Input u0-u19	customType	Intermediate values from stick used for arcade mode
 2600-2619	Stick Input d0-d19	customType	Intermediate values from stick used for arcade mode - delta values

ID	Name	Units/ Values	Description
2700-2739	Operation Variable 00-39	customType	Configurable values used in different guidances - Position or values or vectors
 2800	Wind Velocity North	m/s	Wind velocity vector pointing North direction (NED Coordinate system)
 2801	Wind Velocity East	m/s	Wind velocity vector pointing East direction (NED Coordinate system)
 2802	Wind Velocity Down	m/s	Wind velocity vector pointing Down direction (NED Coordinate system)
 2803	Wind Velocity Estimation Uncertainty (Element 0-0) (Deprecated)	m/s	0-0 element from covariance matrix in wind estimation



ID	Name	Units/ Values	Description
			<p>Warning Deprecated variable</p>
 2804	Wind Velocity Estimation Uncertainty (Element 1-0) (Deprecated)	m/s	1-0 element from covariance matrix in wind estimation <p>Warning Deprecated variable</p>
 2805	Wind Velocity Estimation Uncertainty (Element 2-0) (Deprecated)	m/s	2-0 element from covariance matrix in wind estimation <p>Warning Deprecated variable</p>
 2806	Wind Velocity Estimation Uncertainty (Element 0-1) (Deprecated)	m/s	0-1 element from covariance matrix in wind estimation <p>Warning Deprecated variable</p>

ID	Name	Units/ Values	Description
 2807	Wind Velocity Estimation Uncertainty (Element 1-1) (Deprecated)	m/s	1-1 element from covariance matrix in wind estimation <div style="background-color: #fff9c4; padding: 5px; border: 1px solid #ccc;"> <p style="margin: 0;">Warning Deprecated variable</p> </div>
 2808	Wind Velocity Estimation Uncertainty (Element 2-1) (Deprecated)	m/s	2-1 element from covariance matrix in wind estimation <div style="background-color: #fff9c4; padding: 5px; border: 1px solid #ccc;"> <p style="margin: 0;">Warning Deprecated variable</p> </div>
 2809	Wind Velocity Estimation Uncertainty (Element 0-2) (Deprecated)	m/s	0-2 element from covariance matrix in wind estimation <div style="background-color: #fff9c4; padding: 5px; border: 1px solid #ccc;"> <p style="margin: 0;">Warning Deprecated variable</p> </div>
 2810	Wind Velocity Estimation Uncertainty	m/s	1-2 element from covariance matrix in wind

ID	Name	Units/ Values	Description
	(Element 1-2) (Deprecated)		estimation Warning Deprecated variable
 2811	Wind Velocity Estimation Uncertainty (Element 2-2) (Deprecated)	m/s	2-2 element from covariance matrix in wind estimation Warning Deprecated variable
 2812	Wind Azimuth Angle (Deprecated)	degree	Wind estimated azimuth Warning Deprecated variable
 2813	Wind Velocity in North-East plane (Deprecated)	m/s	Wind velocity norm xy in North- East plane Warning Deprecated variable

ID	Name	Units/ Values	Description
 2814	Head wind velocity North	m/s	Head wind velocity North
 2815	Head wind velocity East	m/s	Head wind velocity East
 2816	Head wind velocity Down	m/s	Head wind velocity Down
2830-2893	Setup real 00-63	customType	Setup variable 00-63
 2900	MSL Right from Actual QNH and Pressure Measurement	m	Mean Sea Level obtained from Actual QNH and current Pressure Measurement
 2901	MSL for ISA and Pressure Measurement	m	Mean Sea Level calculated for ISO International Standard Atmosphere and Pressure Measurement
2902	Time Since Entering Current Phase	s	Time-lapse considered since entering the current phase
2903	GNC Timestep	s	Task execution period from GNC

ID	Name	Units/ Values	Description
2904	Total Flight Time	s	Time-lapse since the vehicle finished Standby <div style="border-left: 2px solid orange; padding-left: 5px; background-color: #fff9c4;"> Warning Deprecated variable </div>
2905	Total Flight Distance	m	Distance covered by the vehicle in all mission length <div style="border-left: 2px solid orange; padding-left: 5px; background-color: #fff9c4;"> Warning Deprecated variable </div>
2906	Reception Frequency of Simulated Navigation Data	Hz	Frequency at which the system receives Simulation Navigation Data
2907	Reception Frequency of External Navigation Data	Hz	Frequency at which the system receives External Navigation Data
2908-2928	Time in Phase 0-20	s	Time-lapse spent by the vehicle within phase 0-20

ID	Name	Units/ Values	Description
 3000-3031	Simulation Variable 0-31	customType	Variables used for Simulation data
 3100-4099	User Variable 00-999 (Real - 32 Bits)	customType	Free variables for the user to use
4100	Zero	customType	Constant value 0
4101	Rvar Disabled	customType	Disabled variable

Integer Variables (UVar) - 16 Bits

ID	Name	Description
0	Actuator Mode	Index pointing to the flight mode in use
1	Phase Identifier	Index pointing to the active phase
2	Internal ADC 0	Internal ADC pin Warning Variable for internal use
3-7	ADC 0-4	Direct reading of ADC pins
8-18	Internal ADC 1-11	Internal ADC pin

ID	Name	Description
		<p>Warning Variable for internal use</p>
 19	Current envelope (deprecated)	<p>Index pointing to the used envelope</p> <p>Warning Deprecated variable</p>
20	Counter for C2 system	C2 counter to monitor if Core 2 is alive
21	Total memory for blocks allocation (low part)	<p>Total words available for blocks (low part). It is stored in two parts because the size can be a number up to 32 bits, but the uvars are stored in variables of 16, so to get the true size the user would have to put together both the low and the high part.</p>

ID	Name	Description
		<p>Note</p> <p>1 word = 2 bytes</p>
22	Total memory for blocks allocation (high part)	<p>Total words available for blocks (high part). It is stored in two parts because the size can be a number up to 32 bits, but the uvars are stored in variables of 16, so to get the true size the user would have to put together both the low and the high part.</p> <p>Note</p> <p>1 word = 2 bytes</p>
23	Memory used for blocks allocation (low part)	<p>Words used for blocks in allocator (low part). It is stored in two parts because the size can be a number up to 32</p>

ID	Name	Description
		<p>bits, but the uvars are stored in variables of 16, so to get the true size the user would have to put together both the low and the high part.</p> <div data-bbox="671 790 997 994" style="border-left: 2px solid #0070C0; background-color: #E6F2FF; padding: 5px;"> <p>Note 1 word = 2 bytes</p> </div>
24	Memory used for blocks allocation (high part)	<p>Words used for blocks in allocator (high part). It is stored in two parts because the size can be a number up to 32 bits, but the uvars are stored in variables of 16, so to get the true size the user would have to put together both the low and the high part.</p>

ID	Name	Description
		<p style="text-align: center;">Note</p> <p style="text-align: center;">1 word = 2 bytes</p>
25	SRTM source at UAV's position	<p>Index for the SRTM source type:</p> <ul style="list-style-type: none"> • 0: Processing • 1: Invalid • 2: 90-meter resolution in equator • 3: 30-meter resolution in equator
26	Stanag Flight Termination Mode	<p>Specific mode for flight termination according to STANAG standards</p>
50	PDI error source	<p>Index for PDI error source identification. For further information, consult the List of PDI errors</p>
51	Operation error source	<p>Index for operation error source identification</p>

ID	Name	Description
53	4X Veronte ID	<p>ID of this AP in a redundant (0-3) to compare with the selected CAP.</p> <p>For more information, check Integer Variables - 4x Software Manual</p>
54	4X Veronte CAP	<p>Current Autopilot 1x selected.</p> <p>For more information, check Integer Variables - 4x Software Manual</p>
 55-75	4X Integer variables	<p>For more information, check Integer Variables - 4x Software Manual</p>
80	Detour calculation identifier	Counter of number of times a route change has been calculated
81	Approach calculation identifier	Counter of number of times Approach guidance has been calculated

ID	Name	Description
82	Climb calculation identifier	Counter of number of times Climb guidance has been calculated
83	Cruise calculation identifier	Counter of number of times Cruise guidance has been calculated
84	Rendezvous calculation identifier	Counter of number of times Rendezvous guidance has been calculated
85	Taxi calculation identifier	Counter of number of times Taxi guidance has been calculated
86	VTOL calculation identifier	Counter of number of times VTOL guidance has been calculated
90	Version Major	Major software version
91	Version Minor	Minor software version
92	Version Revision	Revision software version

ID	Name	Description
93	UAV address (hight)	Higher part of the UAV system address
94	UAV address (low)	Lower part of the UAV system address
95	UAV address	UAV address
96	File system status	State error for DFS2 FS For further information, consult the List of File System Errors
97	Number of registered partitions on DFS2 File System	Number of registered partitions on DFS2 File System
100	GNSS1 Number of Satellites Used in Solution	Number of satellites used in solution
101-102	GNSS1 rejected- accepted RTCM 1005	Number of RTCM rejected by wrong CRC - correctly received by Ublox 1005

ID	Name	Description
103-104	GNSS1 rejected- accepted RTCM 1077	Number of RTCM rejected by wrong CRC - correctly received by Ublox 1077
105-106	GNSS1 rejected- accepted RTCM 1087	Number of RTCM rejected by wrong CRC - correctly received by Ublox 1087
107-108	GNSS1 rejected- accepted RTCM 1127	Number of RTCM rejected by wrong CRC - correctly received by Ublox 1127
109-110	GNSS1 rejected- accepted RTCM 1230	Number of RTCM rejected by wrong CRC - correctly received by Ublox 1230
111-112	GNSS1 rejected- accepted RTCM 4072	Number of RTCM rejected by wrong CRC - correctly received by Ublox 4072
113	GNSS1 rejected RTCM unknown type	Number of RTCM unknown rejected by wrong CRC

ID	Name	Description
114	GNSS1 week	GNSS1 week
115	GNSS1 Jamming Status	<p>Output from GPS 1 jamming/interference monitor:</p> <ul style="list-style-type: none"> • 0 = unknown or feature disabled • 1 = ok ⇒ no significant jamming • 2 = warning ⇒ interference visible but fix Ok • 3 = critical ⇒ interference visible and no fix
116	GNSS1 Spoofing detection state	GNSS1 Spoofing detection state
117	Total number of Uvars used by GPS	Total number of Uvars used by GPS
150	GNSS2 Number of	

ID	Name	Description
	Satellites Used in Solution	Number of Satellites Used in Solution
151-152	GNSS2 rejected-accepted RTCM 1005	Number of RTCM rejected by wrong CRC - correctly received by Ublox 1005
153-154	GNSS2 rejected-accepted RTCM 1077	Number of RTCM rejected by wrong CRC - correctly received by Ublox 1077
155-156	GNSS2 rejected-accepted RTCM 1087	Number of RTCM rejected by wrong CRC - correctly received by Ublox 1087
157-158	GNSS2 rejected-accepted RTCM 1127	Number of RTCM rejected by wrong CRC - correctly received by Ublox 1127
159-160	GNSS2 rejected-accepted RTCM 1230	Number of RTCM rejected by wrong CRC - correctly received by Ublox 1230



ID	Name	Description
161-162	GNSS2 rejected-accepted RTCM 4072	Number of RTCM rejected by wrong CRC - correctly received by Ublox 4072
163	GNSS2 rejected RTCM unknown type	Number of RTCM unknown rejected by wrong CRC
164	GNSS2 week	GNSS2 week
165	GNSS2 Jamming Status	<p>Output from GPS 2 jamming/interference monitor:</p> <ul style="list-style-type: none"> • 0 = unknown or feature disabled • 1 = ok ⇒ no significant jamming • 2 = warning ⇒ interference visible but fix Ok • 3 = critical ⇒ interference visible and no fix
166		

ID	Name	Description
	GNSS2 Spoofing detection state	GNSS2 Spoofing detection state
200	Radar Altimeter State	Index for the radar altimeter state
201	Current Section	ID of current patch being executed by the autopilot
202	Last Achieved Section	ID of last patch completed by the autopilot
203	Track Stage	Index of type of tracked route: <ul style="list-style-type: none"> • 0: No route • 1: Route from mission • 2: Commanded route
204	Current patchset ID	Index showing the patchset:

ID	Name	Description
		<ul style="list-style-type: none"> • 0: Approach • 1: Climb • 2: Route • 3: Taxi • 4: VTOL • 5: Rendezvous • 6: Detour
205	Amount of laps done	Number of laps completed on the route
310-311	Iridium sent-received	Number of packets successfully sent/received
312	Number of UDP packets sent	Total count of UDP telemetry packets transmitted by the system
313	Number of UDP packets received	Total count of UDP packets successfully received
314	Number of UDP packets received but discarded	Count of UDP packets dropped due to errors or buffer issues
315	Number of packets lost	Packets lost in internal communication

ID	Name	Description
	when sending from C1 to CM	between Core 1 and Communications Module
316	Number of packets lost on send from C1 to CM	Internal port transmission loss count from Core 1 to Communications Module
396	Error code for IMU 3	Diagnostic error code generated by the third Inertial Measurement Unit
397	External navigation sensor status	External navigation sensor status
398	VectorNav Mode	Index showing external source VectorNav mode
399	Identifier of max duration step in acquisition	Identifier of maximum duration step in CIO <div data-bbox="671 1704 997 1912" style="background-color: #fff9c4; border: 1px solid #ccc; padding: 5px; margin-top: 10px;"> <p style="text-align: center;">Warning Variable for internal use</p> </div>
400	Interneer raw status	Interneer raw status

ID	Name	Description
401	Navigation source	<p>Index pointing to the primary navigation source:</p> <ul style="list-style-type: none"> • 1: Internal navigation (Extended Kalman Filter) • 2: Simulated navigation (IRX source) • 3: External navigation using VCP (IRX source) • 4: External navigation using dedicated variables • 5: External navigation from Vectornav VN-300 • 6: External sensor navigation
402	Raw position source identifier	GPS identifier selected as main
	Selected static pressure	Static pressure sensor selection



ID	Name	Description
 403	sensor (Deprecated)	<div style="background-color: #fff9c4; padding: 5px; border: 1px solid #ccc;"> <p style="text-align: center;">Warning Deprecated variable</p> </div>
 404	Selected dynamic pressure sensor (Deprecated)	Dynamic pressure sensor selection
405	Selected primary accelerometer (deprecated)	Primary accelerometer selection <div style="background-color: #fff9c4; padding: 5px; border: 1px solid #ccc;"> <p style="text-align: center;">Warning Deprecated variable</p> </div>
406	Selected primary gyroscope (deprecated)	Primary gyroscope selection <div style="background-color: #fff9c4; padding: 5px; border: 1px solid #ccc;"> <p style="text-align: center;">Warning Deprecated variable</p> </div>
 409	Selected magnetometer (Deprecated)	Magnetometer selection

ID	Name	Description
		<p style="text-align: center;">Warning Deprecated variable</p>
410	Selected stick priority table	Stick priority table selection
425	Identifier of max duration step in GNC	Step with maximum duration
426	Group of user bits selected for CBIT	<p>Index pointing to the selected list of safety bits.</p> <p>This is the group of user bits selected to be computed with system CBIT.</p>
441	Serial to CAN 0 frames dropped	Frames lost during serial data encapsulation into CAN 0 bus
442	Serial to CAN 1 frames dropped	Frames lost during serial data encapsulation into CAN 1 bus
443	Serial to CAN 2 frames dropped	Frames lost during serial data encapsulation into CAN 2 bus

ID	Name	Description
444	Serial to CAN 3 frames dropped	Frames lost during serial data encapsulation into CAN 3 bus
445	Serial to CAN 4 frames dropped	Frames lost during serial data encapsulation into CAN 4 bus
446	Serial to CAN 5 frames dropped	Frames lost during serial data encapsulation into CAN 5 bus
447	CAN-FD Tx errors	Transmission error count for the CAN Flexible Data-rate bus
448	CAN-FD Rx errors	Reception error count for the CAN Flexible Data-rate bus
449	Configured system errors that had triggered	Bitarray containing the errors that can trigger the System Error.
450	CAN-A Tx errors	CAN A communication errors in transmission

ID	Name	Description
451	CAN-A Rx errors	CAN A communication errors in reception
452	CAN-B Tx errors	CAN B communication errors in transmission
453	CAN-B Rx errors	CAN B communication errors in reception
454-459	CAN to Serial 0-5 frames dropped	Lost messages during CAN to Serial transformations
460-461	First-Last file Periodic log	First-Last file of the periodic log
462-463	First-Last file Event log	First-Last file of the event log
464-465	First-Last file Fast log	First-Last file of the fast log
466	First file RAM log	Identifier of the first log file stored in RAM memory
467	Last file RAM log	Identifier of the latest log file stored in RAM memory

ID	Name	Description
480-485	COM0-5 packet discarded	Discarded packets at COM 0-5
490	Number of moving obstacles detected	Number of moving obstacles detected
491-492	Veronte static cfg CRC(no Operation) of files (Higher- Lower 16 bits)	Veronte static cfg CRC (no Op.) of files
493-494	Veronte static cfg CRC(no Operation) of memory (Higher-Lower 16 bits)	Veronte static cfg CRC (no Op.) of memory
495-496	Global configuration state (crc) of files-memory (Higher-Lower 16 bits)	Global configuration state (crc) of files and memory
497	Config manager status (flash / sd /	Configuration manager status



ID	Name	Description
	maintenance mode)	
498-499	Global configuration state (crc) of files-memory	Global configuration state (crc) of files and memory
 550-557	Reserved 0-7	System reserved variables for Gimbal
600-615	PPM channel 0-15 output	CEX PPM channel outputs
620	Jetibox max successfully parsed message	<div style="background-color: #e0f2f1; padding: 10px; border-left: 3px solid #00796b;"> <p style="text-align: center;">Note CEX variable</p> </div>
700	Planet Satcom connection Status	Planet Satcom connection Status
701	Planet Satcom signal strength	Planet Satcom signal strength
 710	ADS-B OUT - Squawk Code	<p>ADS-B Squawk code, 4 digits that allow the operator to inform about its status.</p> <p>This variable is closely related to</p>

ID	Name	Description
		<p>the management of communications between transponders and Veronte Autopilot 1x.</p> <div style="border-left: 2px solid orange; padding-left: 10px; margin-top: 10px;"> <p>Warning</p> <ul style="list-style-type: none"> • Deprecated variable • If the user modifies this variable, it is not guaranteed that the transponder will continue to function correctly </div>
 711	ADS-B OUT - ICAO	<p>ADS-B ICAO, 4 ASCII characters assigned by aircraft authority as an identifier.</p> <p>This variable is closely related to the management of communications between transponders and Veronte Autopilot</p>

ID	Name	Description
		<p>1x.</p> <div style="background-color: #fff9c4; padding: 10px; border-left: 2px solid #ffc107;"> <p>Warning</p> <ul style="list-style-type: none"> • Deprecated variable • If the user modifies this variable, it is not guaranteed that the transponder will continue to function correctly </div>
 712	ADS-B OUT - Ident	<p>Index indicating whether the identification is enabled or disabled.</p> <p>This is the identification of the UAV at the request of ATC.</p> <p>This variable is closely related to the management of communications between transponders and Veronte Autopilot</p>

ID	Name	Description
		<p>1x.</p> <div style="background-color: #fff9c4; border-left: 2px solid #ffc107; padding-left: 10px;"> <p>Warning</p> <ul style="list-style-type: none"> • Deprecated variable • If the user modifies this variable, it is not guaranteed that the transponder will continue to function correctly </div>
 713	ADS-B OUT - Mode	<p>Index of ADS-B mode: IN, OUT or BOTH.</p> <p>This variable is closely related to the management of communications between transponders and Veronte Autopilot</p> <p>1x.</p>

ID	Name	Description
		<p>Warning</p> <ul style="list-style-type: none"> • Deprecated variable • If the user modifies this variable, it is not guaranteed that the transponder will continue to function correctly
 714-721	ADS-B OUT - Call sign 0-7	ADS-B Call sign, 9 ASCII characters used by the operator to be identified during communication. These variables are closely related to the management of communications between transponders and Veronte Autopilot 1x.

ID	Name	Description
		<p>Warning</p> <ul style="list-style-type: none"> • Deprecated variables • If the user modifies these variables, it is not guaranteed that the transponder will continue to function correctly
 730	Ping1090 - Sequence number (Deprecated)	<p>Warning</p> <p>Deprecated variable</p>
 741	Sagetech MXS - Hemisphere data status (Deprecated)	Sagetech variable, used by block to parse variables for GPS Navigation Data Message.

ID	Name	Description
		<p>Warning</p> <ul style="list-style-type: none"> • Variable for internal use (custom message for transponder) • If the user modifies this variable, it is not guaranteed that the transponder will continue to function correctly
 742	Sagetech MXS - Ground track (Deprecated)	Sagetech variable, used by block to parse variables for GPS Navigation Data Message.

ID	Name	Description
		<p>Warning</p> <ul style="list-style-type: none"> • Variable for internal use (custom message for transponder) • If the user modifies this variable, it is not guaranteed that the transponder will continue to function correctly
 743	Sagetech MXS - Air speed (Deprecated)	Sagetech variable, used by block to parse variables for GPS Navigation Data Message.

ID	Name	Description
		<p>Warning</p> <ul style="list-style-type: none"> • Variable for internal use (custom message for transponder) • If the user modifies this variable, it is not guaranteed that the transponder will continue to function correctly
 750	ADS-B Out / ICAO High	<p>ADS-B ICAO, 4 ASCII characters assigned by aircraft authority as an identifier.</p> <p>This variable is closely related to the management of communications between transponders and Veronte Autopilot 1x.</p>

ID	Name	Description
		<p>Warning</p> <ul style="list-style-type: none"> • Variable for internal use (custom message for transponder) • If the user modifies this variable, it is not guaranteed that the transponder will continue to function correctly
 751	ADS-B Out / ICAO Low	ADS-B ICAO, 4 ASCII characters assigned by aircraft authority as an identifier. This variable is closely related to the management of communications between transponders and Veronte Autopilot 1x.

ID	Name	Description
		<p>Warning</p> <ul style="list-style-type: none"> • Variable for internal use (custom message for transponder) • If the user modifies this variable, it is not guaranteed that the transponder will continue to function correctly
 752	ADS-B Out / Emitter Type	<p>Type/category of ADS-B emitter. This variable is closely related to the management of communications between transponders and Veronte Autopilot 1x.</p>

ID	Name	Description
		<p>Warning</p> <ul style="list-style-type: none"> • Variable for internal use (custom message for transponder) • If the user modifies this variable, it is not guaranteed that the transponder will continue to function correctly
 753-760	ADS-B Out / Call Sign 0-7	<p>ADS-B Call sign, 9 ASCII characters used by operator to be identified during communication.</p> <p>This variable is closely related to the management of communications between transponders and Veronte Autopilot 1x.</p>



ID	Name	Description
		<p>Warning</p> <ul style="list-style-type: none"> • Variabled for internal use (custom message for transponder) • If the user modifies these variables, it is not guaranteed that the transponder will continue to function correctly
 761	ADS-B Out / Type	Model of ADS-B transponder. This variable is closely related to the management of communications between transponders and Veronte Autopilot 1x.



ID	Name	Description
		<p>Warning</p> <ul style="list-style-type: none"> • Variable for internal use (custom message for transponder) • If the user modifies this variable, it is not guaranteed that the transponder will continue to function correctly
 762	ADS-B Out / Control	<p>Index of ADS-B control: OFF, ADS-B IN, ADS-B OUT or BOTH (ADS-B IN and OUT).</p> <p>This variable is closely related to the management of communications between transponders and Veronte Autopilot 1x.</p>

ID	Name	Description
		<p>Warning</p> <ul style="list-style-type: none"> • Variable for internal use (custom message for transponder) • If the user modifies this variable, it is not guaranteed that the transponder will continue to function correctly
 763	ADS-B Out / Squawk	<p>ADS-B Squawk code, 4 digits that allow the operator to inform about its status.</p> <p>This variable is closely related to the management of communications between transponders and Veronte Autopilot 1x.</p>

ID	Name	Description
		<p>Warning</p> <ul style="list-style-type: none"> • Variable for internal use (custom message for transponder) • If the user modifies this variable, it is not guaranteed that the transponder will continue to function correctly
 764	ADS-B Out / Ident	<p>Index indicating whether the identification is enabled or disabled.</p> <p>This is the identification of the UAV at the request of ATC.</p> <p>This variable is closely related to the management of communications between transponders and</p>

ID	Name	Description
		<p>Veronte Autopilot 1x.</p> <div style="background-color: #fff9c4; padding: 10px; border: 1px solid #ccc;"> <p>Warning</p> <ul style="list-style-type: none"> • Variable for internal use (custom message for transponder) • If the user modifies this variable, it is not guaranteed that the transponder will continue to function correctly </div>
 765	ADS-B Out / Custom	<p>Variable for internal use for ADS-B Out. This variable is closely related to the management of communications between transponders and Veronte Autopilot 1x.</p>

ID	Name	Description
		<p>Warning</p> <ul style="list-style-type: none"> • Variable for internal use (custom message for transponder) • If the user modifies this variable, it is not guaranteed that the transponder will continue to function correctly
 800	MC Fault Id	<p>Index of the MC error</p> <p>Warning Deprecated variable</p>
 801	MC Input Control Mode	<p>Index of the MC control input mode:</p>

ID	Name	Description
		<ul style="list-style-type: none"> • 1: PPM • 2: CAN • 3: both modes active (CAN priority)
 802	MC Actual Control Machine State	State of motor controller: <ul style="list-style-type: none"> • 0: Motor stop and driver disabled • 1: Calibration of ADC reading • 2: Initial alignment procedure • 3: Open loop procedure • 4: Speed mode
 900-909	Simulation variable 00-09	Variables used for simulation data
 1000-1999	User Variable 00-999 (Unsigned Integer - 16 bits)	Free variables for user
2000	Uvar Disabled	Disabled variable
2001	Zero	

ID	Name	Description
		Variable with constant 0 value

Features Variables - 64 Bits

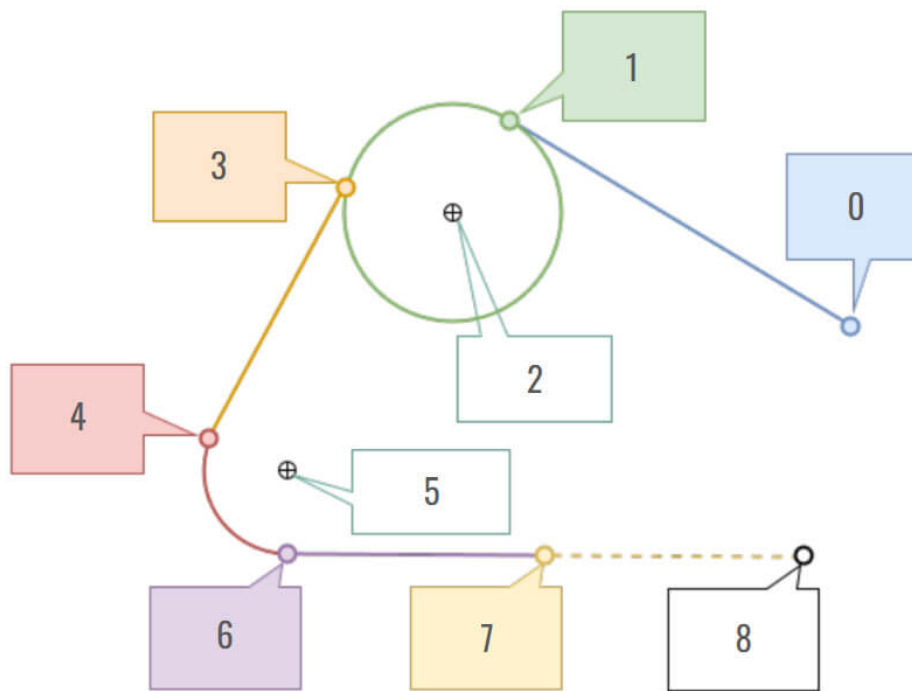

Landing route - Features variables

ID	Name	Form	Units	Description
0	Approach Initial Point	[lon, lat, height]	[rad, rad, m]	Landing Guidance Variable. Point 0 in Landing capture .
1	Approach Loiter Start	[lon, lat, height]	[rad, rad, m]	Landing Guidance Variable. Point 1 in

ID	Name	Form	Units	Description
				Landing capture.
2	Approach Loiter Center	[lon, lat, height]	[rad, rad, m]	Landing Guidance Variable. Point 2 in Landing capture.
3	Approach Loiter Finish	[lon, lat, height]	[rad, rad, m]	Landing Guidance Variable. Point 3 in Landing capture.
4	Approach Headturn Start	[lon, lat, height]	[rad, rad, m]	Landing Guidance Variable. Point 4 in Landing capture.
5	Approach Headturn Center	[lon, lat, height]	[rad, rad, m]	Landing Guidance Variable. Point 5 in Landing capture.
6	Approach Headturn Finish	[lon, lat, height]	[rad, rad, m]	Landing Guidance Variable. Point 6 in

ID	Name	Form	Units	Description
				Landing capture.
7	Approach Touch Point	[lon, lat, height]	[rad, rad, m]	Landing Guidance Variable. Point 7 in Landing capture.
8	Approach Runway End	[lon, lat, height]	[rad, rad, m]	Landing Guidance Variable. Point 8 in Landing capture.

 **Note**

For further information regarding Landing guidance, please refer to [Landing - Guidance blocks](#) of **Block Programs** section of the **1x PDI Builder** user manual.

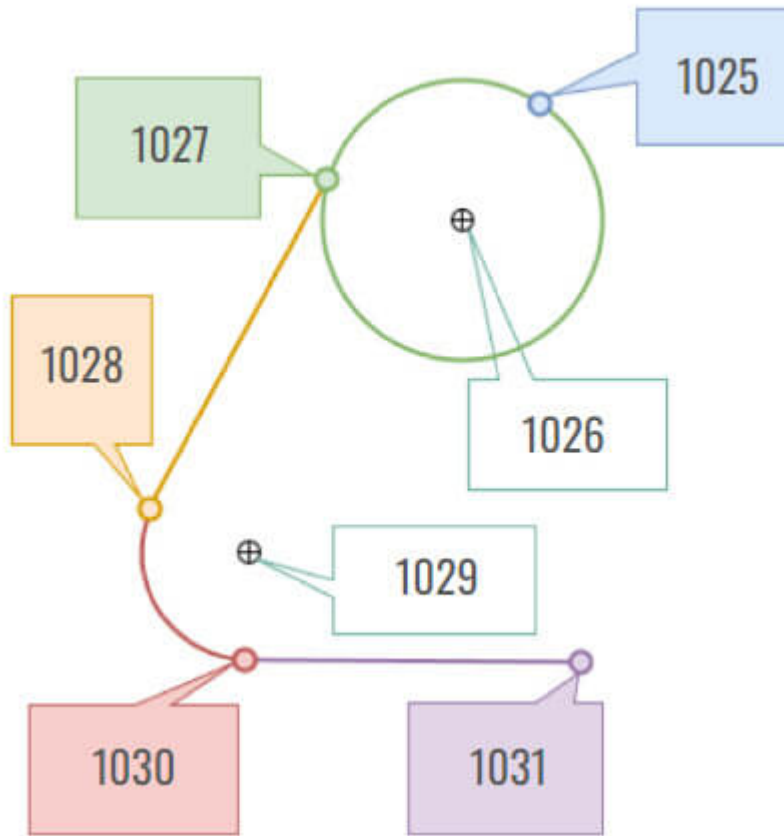

Climbing route - Features variables

ID	Name	Form	Units	Description
1025	Climb First Loiter Point	[lon, lat, height]	[rad, rad, m]	Climbing Guidance Variable. Point 1025 in Climbing capture .
1026	Climb Loiter Center	[lon, lat, height]	[rad, rad, m]	Climbing Guidance Variable. Point 1026 in Climbing capture .

ID	Name	Form	Units	Description
1027	Climb Start Loiter	[lon, lat, height]	[rad, rad, m]	Climbing Guidance Variable. Point 1027 in Climbing capture .
1028	Climb Finish Headturn	[lon, lat, height]	[rad, rad, m]	Climbing Guidance Variable. Point 1028 in Climbing capture .
1029	Climb Headturn Center	[lon, lat, height]	[rad, rad, m]	Climbing Guidance Variable. Point 1029 in Climbing capture .
1030	Climb Start Headturn	[lon, lat, height]	[rad, rad, m]	Climbing Guidance Variable. Point 1030 in Climbing capture .
1031	Climb Initial Point	[lon, lat, height]	[rad, rad, m]	Climbing Guidance Variable. Point 1031 in Climbing capture .

Note

For further information regarding Climbing guidance, please refer to [Climb - Guidance blocks](#) of **Block Programs** section of the **1x PDI Builder** user manual.

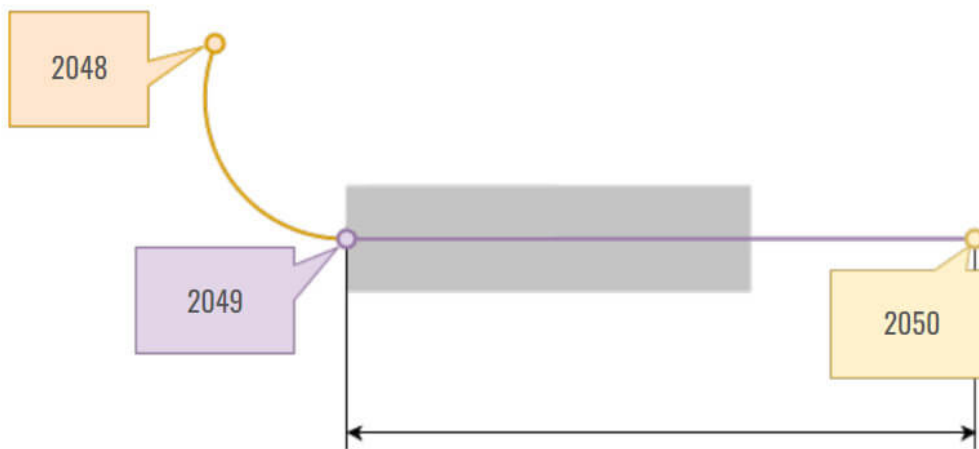

Taxi route - Features variables

ID	Name	Form	Units	Description
2048	Taxi Initial Point	[lon, lat, height]	[rad, rad, m]	Taxi Guidance Variable. Point 2048 in Taxi capture .
2049	Taxi Runway First Point	[lon, lat, height]	[rad, rad, m]	Taxi Guidance Variable. Point 2049

ID	Name	Form	Units	Description
				in Taxi capture .
2050	Taxi Runway Final Point	[lon, lat, height]	[rad, rad, m]	Taxi Guidance Variable. Point 2050 in Taxi capture .

Note

For further information regarding Taxi guidance, please refer to [Taxi - Guidance blocks](#) of **Block Programs** section of the **1x PDI Builder** user manual.

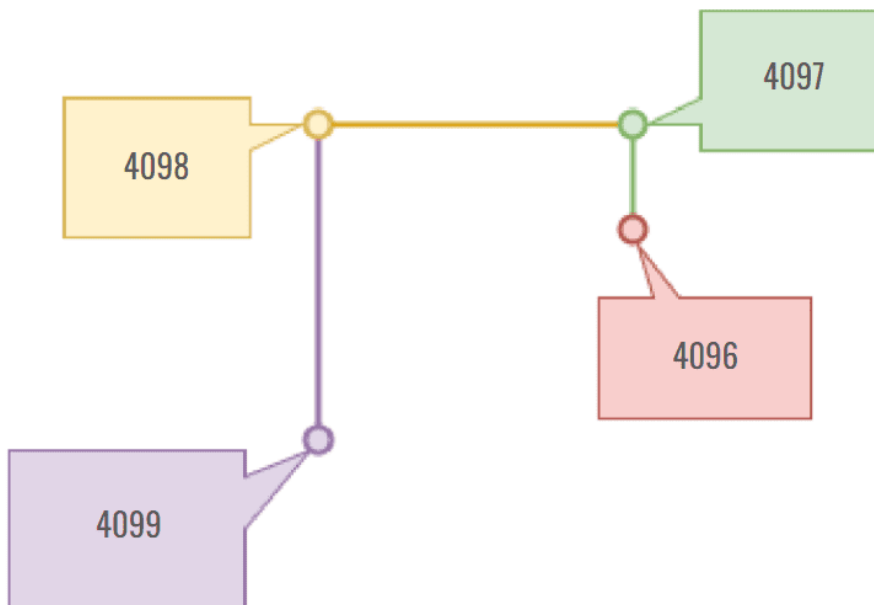

VTOL route - Features variables

ID	Name	Form	Units	Description
4096	Vtol 00	[lon, lat, height]	[rad, rad, m]	VTOL Initial point. Point 4096 in VTOL route capture .
4097	Vtol 01	[lon, lat, height]	[rad, rad, m]	VTOL Translate Start. Point 4097 in VTOL route capture .
4098	Vtol 02	[lon, lat, height]	[rad, rad, m]	VTOL Translate End. Point 4098 in VTOL route capture .
4099	Vtol 03	[lon, lat, height]	[rad, rad, m]	VTOL End point. Point 4099 in VTOL route capture .

 **Note**

For further information regarding VTOL guidance, please refer to [VTOL - Guidance blocks](#) of **Block Programs** section of the **1x PDI Builder** user manual.

ID	Name	Form	Units	Description
3072	Regvars 00	[lon, lat, height]	[rad, rad, m]	Regvar Feature Variable.
5120 - 5124	Detour 00 - 04	[lon, lat, height]	[rad, rad, m]	Detour Feature Variables.
6144	Runway Loiter	[lon, lat, height]	[rad, rad, m]	Runway Guidance Variable.
6145	Runway Touch Point	[lon, lat, height]	[rad, rad, m]	Runway Guidance Variable.
6146	Runway End Position	[lon, lat, height]	[rad, rad, m]	Runway Guidance Variable.
7168 - 7169	Gimbal Pointing 00 - 01	[lon, lat, height]	[rad, rad, m]	Gimbal Pointing.
8192	UAV position	[lon, lat, height]	[rad, rad, m]	UAV position.
8193	Current phase	[lon, lat, height]	[rad, rad, m]	Current phase.
8194				Desired position.

ID	Name	Form	Units	Description
	Desired position	[lon, lat, height]	[rad, rad, m]	
8195	Value used when invalid ID is tried	[lon, lat, height]	[rad, rad, m]	Auxiliar feature - Not valid for users.
8196	Track position	[lon, lat, height]	[rad, rad, m]	Closer point in route to the current desired position.
8197	Operator position	[lon, lat, height]	[rad, rad, m]	Operator position.
8198	Start waypoint in current route	[lon, lat, height]	[rad, rad, m]	Start waypoint in current route.
8199	End waypoint in current route	[lon, lat, height]	[rad, rad, m]	End waypoint in current route.
9216 - 9235	Phase 00 - 19	[lon, lat, height]	[rad, rad, m]	Phase.
10240 - 10247	Inflight Reference Point 00 - 07	[lon, lat, height]	[rad, rad, m]	Absolute or relative reference position useful during mission.
11264 - 11327	Obstacle Sensor 00 - 63	[lon, lat, height]	[rad, rad, m]	Obstacle Sensor.

ID	Name	Form	Units	Description
12288	Rendezvous 00	[lon, lat, height]	[rad, rad, m]	Start point. For further information, please refer to Rendezvous - Guidance blocks of Block Programs section of the 1x PDI Builder user manual.
12289	Rendezvous 01	[lon, lat, height]	[rad, rad, m]	Rendezvous relative point. For further information, please refer to Rendezvous - Guidance blocks of Block Programs section of the 1x PDI Builder user manual.
12290	Rendezvous 02	[lon, lat, height]	[rad, rad, m]	Docking relative point. For further information, please refer to Rendezvous - Guidance blocks of Block Programs section of the 1x PDI Builder user manual.
13312 - 13327	Moving Obstacles 00 - 15	[lon, lat, height]	[rad, rad, m]	Moving Obstacle.
				1x PDI Builder allows the configuration of up to 6

ID	Name	Form	Units	Description
14336 - 14353	Fixed runway features 00 - 17	[lon, lat, height]	[rad, rad, m]	<p>runways.</p> <p>Each runway has 3 main points, Initial point, End point, and Loiter Center, which are repeated every three IDs.</p> <p>E.g. Initial point for Runway 0 is 14336, for Runway 1 is 14339, for Runway 2 is 14342, etc.</p>
15360 - 15371	Fixed spot features 00 - 11	[lon, lat, height]	[rad, rad, m]	<p>1x PDI Builder allows the configuration of up to 6 spots.</p> <p>Each spot has 2 main points, Spot coordinates and Loiter Center, which are repeated every two IDs.</p> <p>E.g. Spot coordinates for Spot 0 is 15360, for Spot 1 is 15362, for Spot 2 is 15364, etc.</p>
28672 - 28703	Moving Objects 00 - 31	[lon, lat, height]	[rad, rad, m]	Moving Objects.

ID	Name	Form	Units	Description
29696 - 30207	Waypoint 00 - 511	[lon, lat, height]	[rad, rad, m]	Route waypoints.
30720 - 30987	Volume vertex 00 - 267	[lon, lat, height]	[rad, rad, m]	Volume vertices.

Navigation Variables

The following variables of the **Autopilot 1x** take part in the **navigation** performance.

Type	ID	Name
Bit Variables	101	No valid SRTM at UAV position
	114	No valid Geoid at UAV position
Real Variables	2	GS (Ground Speed)
	3	Heading
	4	Flight Path Angle
	5	Bank
	6	Yaw
	7	Pitch
	8	Roll

Type	ID	Name
	12	p (Angular Velocity - X Body Axis)
	13	q (Angular Velocity - Y Body Axis)
	14	r (Angular Velocity - Z Body Axis)
	15	Forward Acceleration - X Body Axis
	16	Right Acceleration - Y Body Axis
	17	Bottom Acceleration - Z Body Axis
	18	RPM
	19	Front Ground Velocity
	20	Lateral Ground Velocity
	21	Velocity
	12	Forward Load Factor - X Body Axis
	23	Right Load Factor - Y Body Axis
	24	

Type	ID	Name
		Bottom Load Factor - Z Body Axis
	25	Tangential Acceleration
	26	Estimated air density
	27	Gravity at UAV's position
	28	Co-Yaw
	29	Co-Pitch
	30	Co-Roll
	31	Angular Acceleration - X Body Axis
	32	Angular Acceleration - Y Body Axis
	33	Angular Acceleration - Z Body Axis
	34	Body to NED Quaternion q_s
	35	Body to NED Quaternion q_i
	36	Body to NED Quaternion q_j
	37	

Type	ID	Name
		Body to NED Quaternion qk
	56	Yaw Rate
	57	Pitch Rate
	58	Roll Rate
	80	Estimated gyro bias x
	81	Estimated gyro bias y
	82	Estimated gyro bias z
	83	Estimated accelerometer bias x
	84	Estimated accelerometer bias y
	85	Estimated accelerometer bias z
	500	Longitude
	501	Latitude
	502	WGS84 Elevation (Height Over the Ellipsoid)
	503	

Type	ID	Name
		MSL (Height Above Mean Sea Level) - Altitude
	504	AGL (Above Ground Level) - Height
	505	North Ground Velocity
	506	East Ground Velocity
	507	Down Ground Velocity
	1400	Velocity - X Body Axis
	1401	Velocity - Y Body Axis
	1402	Velocity - Z Body Axis
	2103	Acceleration North
	2104	Acceleration East
	2105	Acceleration Down
Integer Variable	25	SRTM source at UAV's position
Feature Variable	8192	UAV position

List of PDI Errors

The following table explains the list of possible errors from Veronte applications.

Note

The decimal value of the PDI Error Source (UVar 50) represents the PDI error ID listed in the following table.

Code	Nº	Explanation
err_ok	0	No errors detected
err_gpio	1	GPIOs function configuration
err_odt_pool_sz	2	Incorrect pool size in on-demand telemetry
err_telemetry_alloc	3	Could not allocate new telemetry vector
err_patch_type	4	Incorrect patch type
err_patch_needs_next	5	Selected type of patch needs a next
err_max_poly_evt	6	Maximum limit of polygon events reached
err_channelmgr	10	Channel manager configuration
err_blk_cmp_pdi	11	Incorrect deserialization of compiled block data
err_blk_cmp	12	Incorrect output in compiled block

Code	Nº	Explanation
err_blk_cmp_desc	13	Invalid pin description in compiled block
err_sara	15	SARA sim type oor.
err_vblk_sensrtm	16	Block for SRTM sensor
err_arcx	23	Arcade axis set of options.
err_msg8_consumer_hi	24	Custom message consumer cannot be used in HI unless it is an external sensor
err_can_consumer_hi	25	CAN Custom message consumer cannot be used in HI unless it is an external sensor
err_modes	27	Stick configuration modes
err_blkekfstp	41	Static pressure to EKF adapter block
err_gnss_blocks	45	GNSS constellations configuration (more than allowed)
err_cansuite_gpio	47	CAN suite gpio
err_vrng	48	Range sensors
err_fmset	50	Custom message set
err_pwm	54	Pwm configuration
err_sniffer	63	Sniffer wires configuration

Code	Nº	Explanation
err_sniffer_read_only	64	Read-only variable selected in sniffer
err_fmsgc_read_only	65	Read-only variable selected in serial message consumer
err_canmsgc_read_only	66	Read-only variable selected in CAN message consumer
err_vref_read_only	67	Read-only vref variable
err_obstacle	68	Incorrect type of obstacle.
err_obsense	69	Obstacle sensing mode or type oor.
err_marks	71	Incorrect type of mark.
err_ext_nav_sen	72	Incorrect external navigation sensor configuration.
err_fmsg_p	74	Custom message producers msg id oor.
err_fmsg_c	75	Custom message consumers process parser oor.
err_fmsgcan_c	76	CAN custom msg consumer msg id oor.
err_telem	77	Telemetry configuration
err_fmsg_p_sz	78	Custom message producer occupancy is higher than allowed
err_fmsg_c_sz	79	

Code	Nº	Explanation
		Custom message consumer occupancy is higher than allowed
err_sci	81	SCI config error
err_events	82	Invalid event
err_actions	83	Actmgr - List of actions.
err_evact	84	Actmgr - List of related events and actions.
err_cmd_not_allowed	85	Commands not allowed
err_xpc_can_in	87	XPC for CAN messages input filters size ok
err_xpc_can_out	88	XPC for CAN messages output filters size ok
err_xpc_can_ser	89	XPC for CAN messages serialtoCAN size ok
err_xpc_can_gpio	90	XPC for CAN messages virtual gpios size ok
err_xpc_can_map	91	XPC for CAN messages and check their priority and connections.
err_xpc_u8_map	92	XPC for u8 messages and check their priority and connections.
err_internest	93	Internest version in rage
err_internest1	94	

Code	Nº	Explanation
		Internest max_range_vbase in rage
err_internest2	95	Internest max_range_vexplore in rage
err_gravity_ext	96	Incorrect gravity extractor for AHRS configuration
err_u8pkrsarray_size	97	Incorrect size for U8pkrsarray
err_ecap	101	Capture.
err_cappulse	116	ECAP pulse consumers
err_i2cdevs	117	I2C external devices
err_lossy_resize	120	Lossy resize error
err_rvector_resize	121	Rvector resize error
err_asciiparser	122	ASCII parser invalid configuration
err_telemetry_exceeded	123	Telemetry size exceeded
err_hi_3210_rx_tout	154	HI-3210 rx cannot be configured
err_hi_3210_tx_tout	155	HI-3210 tx cannot be configured
err_arbiter_cfg	156	Arbiter production configurable invalid
err_can_arbiter_cfg	157	CAN Arbiter configuration has not consistency with production file or/and it is invalid

Code	Nº	Explanation
err_cmd_rdvzset	176	Rendezvous command base_yaw oor
err_cmd_taxiget	183	Taxi guidance request command.
err_cmd_gtrack1	188	Invalid detour command
err_cmd_gtrack2	189	Invalid guidance block configuration.
err_cmd_speed	192	Cruise speed command
err_cmd_gtrack	193	Invalid detour command
err_cmd_gtrkset	194	Track request command
err_cmd_stksrcr	208	Get stick raw channels from selected source
err_cmd_vtolset	212	VTOL request command
err_ini_nok	213	Cannot change to a phase different from INI with System BIT not OK and out of PDI mode
err_cmd_nav	215	Navigation command
err_cmd_gpio	218	GPIO command
err_cmd_gpio1	219	GPIO command
err_cmd_gpio2	220	GPIO command
err_cmd_gpio3	221	GPIO command
err_cmd_phase	222	

Code	Nº	Explanation
		Commanded phase is out of range
err_cmd_gimbal1	224	Gimbal commands
err_cmd_gimbal	225	Gimbal commands
err_cmd_var	235	Variable set command
err_reset	239	Reset CPU IRX
err_acc2filt	257	Internal 2 (IMU) Accelerometer filter
err_imu3_filter	258	Internal 3 (IMU) filter not in range [0,6]
err_imu3_filter_bw	259	Internal 3 (IMU) filter not compatible with Bandwidth limit
err_imu3_delta	260	Internal 3 (IMU) invalid rate limit
err_imu2_delta	261	Internal 2 (IMU) invalid rate limit
err_cansuite_in	288	CAN suite producer for veronte
err_cansuite_out	289	CAN suite consumer for veronte
err_cfg_can	290	CAN cfg
err_resize_can_cex	291	CEX CAN cfg
err_resize_can_commex	292	COMMEX CAN cfg
err_jeti_and_lift	293	Trying to configure jeti and lift (not enough memory)

Code	Nº	Explanation
err_relf	500	Tried to set feature relative to invalid feature, or set relative an "absolute-only" feature
err_jid	501	Invalid feature
err_canid	502	Invalid CAN id
err_cfgid_mode0	503	Invalid Cfgid PDI (number of PDIs does not match)
err_cfgid_mode1	504	Invalid Cfgid PDI mode
err_cmd_mgr	505	Expected command size does not match
err_cmd_mgr1	506	Expected command size does not match
err_cancfg	507	Invalid CAN configuration
err_decimator	508	Invalid decimator
err_sci_cfg	509	Invalid SCI configuration
err_field1	510	Maximum ID of real variable exceeded
err_field2	511	Maximum ID of user variable exceeded
err_field3	512	Maximum ID of bit variable exceeded
err_field4	513	Maximum number of decimals for real variable exceeded

Code	Nº	Explanation
err_field5	514	Overflow for real variable detected
err_field6	515	Incorrect CRC field
err_field7	516	Field matcher number of bits outside range
err_field8	517	Field maximum skippable bits exceeded
err_field9	518	Maximum ID of real variable saved as string exceeded
err_field10	519	Field type out of range
err_flogic	520	Invalid event composition (Flogic)
err_flogic1	521	Invalid event composition (Flogic)
err_flogic2	522	Invalid event composition type
err_fref	523	Invalid type of position reference
err_irxtable	524	Invalid 3Dtable mode or vector is non-decreasing
err_limit	525	Invalid limit event type
err_lsm6ds3_cfg	526	Accelerometer/Gyroscope settings outside range
err_pdi_ver	527	Incompatible PDI version, there are some PDI files in Veronte

Code	Nº	Explanation
		from a different version. Try migrating offline and uploading a complete migrated configuration
err_rvarsensor	528	Id for Rvar out of range for Rvarsensor
err_stickrawtrans0	529	K value in stick outside range [-100, 100] or 0
err_stickrawtrans1	530	Maximum value read from stick for Configured range exceeded [4095]
err_stickrawtrans2	531	Maximum value read from stick for Raw stick trim exceeded [4095]
err_stickrawtrans3	532	Invalid transformation type for stick
err_inc_counter	533	Invalid ID for incremental counter
err_stickcfg3	536	Invalid destination of stick device data
err_tllhcompressed	537	Longitude/Latitude outside range [-pi, pi]/[-0.5pi, 0.5pi]
err_tunpatchset0	538	Patch selected as first has not been enabled
err_tunpatchset1	539	Patch selected as next has not been enabled

Code	Nº	Explanation
err_tunpatchset2	540	Patch type does not exist
err_tunpatchset3	541	The route cannot have two consecutive patches of type point
err_tunpatchset4	542	Patchtype orthodrome has not been enabled
err_tunpatchset5	543	Patchtype arc has not been enabled
err_tunpatchset6	544	Patchtype ellipse has not been enabled
err_tunpatchset8	546	No patchtype has been enabled
err_Ubxcfgnav5	547	Dynmodel out of range or incorrect UTC time
err_Ubxcfgnavx5	548	Maximum acceptable AssistNow Autonomous orbit error outside range [5, 1000]
err_Ubxcfgport	549	Port (for Ubx?) is neither SPI nor SCI
err_Ubxcfgrate	550	Invalid Ublox configuration rate
err_Ubxcfgsbas	551	Maximum number of SBAS prioritized tracking channels exceeded [3]
err_atunarray0	552	Invalid Tunarray index

Code	Nº	Explanation
err_atunarray1	553	Invalid Tunarray size
err_Ubxcfgtmode3	554	Error in receiver mode, neither enabled nor disabled
err_Uclk	555	Invalid chrono event
err_Uvarsensor	556	Id for Uvar out of range for Uvarsensor, or desired frequency too low (<1Hz)
err_Uclkmgr	557	Maximum number of event user chronos exceeded
err_varinit0	558	Maximum array size exceeded on initial values for user variables
err_varinit1	559	Initialized variable is unwritable
err_vref0	560	Maximum ID of Rvar variable exceeded in Vref
err_vref1	561	Maximum ID of Uvar variable exceeded in Vref
err_vref2	562	Maximum ID of Bvar variable exceeded in Vref
err_vref3	563	Invalid type of variable in Vref
err_xclkcfg0	564	Period time non positive in event
err_xclkcfg1	565	Invalid period mode
err_xclkcfg2	566	Chrono position direction not correctly normalized

Code	Nº	Explanation
err_xclkcfg3	567	Invalid type of chrono
err_blk_batch	570	Maximum allowed block nesting depth exceeded [6] or incorrect number of inputs/outputs for block Patch
err_blk_ifelse	571	Error in the connections for block if/else
err_blk_switch	572	Error in the connections for block switch
err_blk_switch0	573	Invalid switch/ifelse/phase block configuration
err_blkmgr	574	Invalid block manager configuration
err_pinmux	576	Invalid switch/ifelse/phase block output configuration
err_blk_switchmap	577	Invalid mapping to cases in switch/phase block
err_accellimit	579	Envelope's falling or rising edge is out of accepted limits
err_polygrp	581	Index of polygon for group outside of range
err_polygon	582	Less than 3 polygon vertices
err_circle	583	Circle radius is less than or equal to 0

Code	Nº	Explanation
err_height	584	Height type is neither relative nor absolute
err_heightabs	585	Invalid absolute height type
err_rwy	586	Invalid runway preferred type
err_driver	588	Problem in Driver block configuration
err_mwk	592	Gyroscope measurement error
err_opinctrl	593	Invalid PID controller input type
err_pid	594	Invalid PID integral configuration (tau must be ≥ 0)
err_prediction	595	Error in the Model Prediction Control algorithm. Prediction Horizon out of range or zero diagonal matrix R
err_sysid	596	Error ID for given pdi check
err_tsched	597	Error ID for given pdi check
err_dwma	598	Error ID for given pdi check
err_iir	599	Error ID for given pdi check
err_butterworth	600	Error ID for given pdi check
err_usre2	601	Error incorrect user sensor variance
err_ubxcfgtp5	603	Ublox time pulse configuration

Code	Nº	Explanation
err_cfgmgr_load_secure	604	Error loading secure mode
err_cfgmgr_finit	605	Error PDI files
err_cfgmgr_timeout	606	Error; timeout while loading PDIs
err_invalidrotmat	607	Invalid rotation matrix (cannot be inverted)
err_flyto_setup	608	Error in fly to waypoint action
err_vblk_apsel	609	Invalid block AP selection configuration, channel exceeds maximum number
err_vblk_arcade_bounce	610	Error in the connections for block Arcade Bounce
err_vblk_arcade_extend	611	Error in the connections for block Arcade Extend
err_vblk_btor	612	Error in the connections for bool to real block
err_vblk_bound	613	Error in the connections for block Bound
err_rldcfg0	614	Invalid dynamic pressure EKF entrance configuration
err_ubx_tout0	616	Could not receive ACKs from UBlox
err_ubx_tout1	617	Could not receive polling from Ublox

Code	Nº	Explanation
err_ubx_nack	618	A Ublox configuration message was rejected by a Ublox device (GNSS)
err_guid_pid	619	Invalid type of guidance controller
err_cmd_leg	620	Guidance uses an invalid runway or site
err_mixarray	622	Error in mixarray construction (possibly there is not enough RAM memory to store all the blocks)
err_xrtable	623	Invalid number of entries for XrTable
err_blk_varset	624	Block trying to write in an invalid variable, possibly the selected variable is not user writable
err_tuntrait	625	Error trying to resize an array out of its maximum size
err_asuite	626	Selected dynamic pressure sensor is not valid in this hardware version
err_xpcmap	627	Invalid producer/consumer in I/O connections
err_blk_arraysplit	628	Invalid block: array of less than 2 elements cannot be split

Code	Nº	Explanation
err_blk_array	629	Bundle block error, it must have more than one input and the input sizes must be one
err_vblk_varget	630	Invalid ID for block Read Real
err_vblk_vec_ops	631	Error in either; Vector: Add, Subtract, Cross product or Matrix rotation
err_autotune	633	Invalid maximum duration of autotuning process or invalid number of stages for FFT
err_vblk_azeld1	634	Error in the connections for block azeld -> xyz
err_vblk_azeld	635	Error in the connections for block xyz -> azeld
err_vblk_dot	636	Error in the connections for block Dot Product
err_vblk_enctrl	637	Error in the connections for block Energy Control or invalid conversion factor from speed difference to desired acceleration
err_vblk_bnxb1	638	Error in the connections for block(s) AND/OR
err_vblk_r1xr1	639	Error in the connections for block
err_vblk_r2xr1	640	

Code	Nº	Explanation
		Error in the connections for block x+y or invalid subfunction for the block
err_vblk_rnrxr1	641	Error in the connections for block(s) Multiply/Add Elements/ Norm or invalid subfunction for the block(s)
err_vblk_iir	642	Error in the connections for block IIR Filter or invalid parameters for the transfer function
err_vblk_kmultvec	643	Error in the connections for block Scale
err_vblk_manual	644	Error in the connections for block Manual or invalid stick control channel
err_vblk_minmax	645	Error in the connections for block(s) Min/Max
err_vblk_mix	646	Error in the connections for block MIX or invalid mix control channel
err_vblk_movern	647	Error in the connections for block MIX Move
err_vblk_not	648	Error in the connections for block NOT
err_vblk_phase	649	Default case does not exist for block Phase Switch

Code	Nº	Explanation
err_vblk_tsched	651	Error in the connections for block T-Sched PID
err_vblk_pid	652	Invalid configuration or connection of a PID block
err_vblk_poly	653	Error in the connections for block Polynomial
err_vblk_posset	654	Error in the connections for block Write Feature or Fid is not user writable
err_vblk_predictive	655	Error in the connections for block Predictive Control or number of elements for numerator/denominator unmatched to the expected input size
err_vblk_ramp	656	Error in the connections for block Ramp or rise time/settling time less than (or equal to) 0
err_vblk_matvec	657	Error in the connections for block Linear Transformation or matrix size unmatched to the expected input size
err_vblk_rtable3d	658	Error in the connections for block 3D Table Interpolation
err_vblk_rtob	659	Error in the connections for block Real to Bool
err_vblk_rtou	660	

Code	Nº	Explanation
		Error in the connections for block Real to Integer
err_vblk_runwrap	661	Error in the connections for block [-pi,pi] Unwrap
err_vblk_utor	662	Error in the connections for block Integer to Real
err_vblk_relthis	663	Error in the connections for block Relative Vector
err_cancfg1	664	Number of mailboxes dedicated to rx exceeds maximum [32] or the filter applied to mailbox subset exceeds maximum filter id
err_stickvar_cfg	665	Decimate time is higher than the minimum period or number of stick virtual inputs exceeds maximum configured for block Virtual stick
err_vblk_gimbal	666	Error in the connections for block Gimbal
err_vblk_hysteresis	667	Error in the connections for block Hysteresis
err_vblk_arctrim	668	Error in the connections for block Arc Trim or control vector unmatched to expected size
err_blockprog	669	

Code	Nº	Explanation
		Incomplete set of LSB bits or with bit holes for execution mask or slot is not within the mask
err_vblk_n2b	670	Error in the connections for block NED to Body/Body to NED
err_vblk_pwm	671	Error in the connections for block PWM or PWM id exceeds maximum
err_vblk_stick	672	Error in stick block, connections, dimensions of matrices or stick sources could be wrong
err_vblk_u2s	673	Error in actuator block, connections or dimensions of matrices could be wrong
err_vblk_interp	674	Error in vector interpolation block, connections or sizes could be wrong, also the points in the table must be sorted in increasing order of x
err_vblk_ratelim	678	Error in the connections for block Rate limiter
err_vblk_clock	679	Unable to reset the clock timer in block Clock
err_vblk_mult_varget	680	Unable to initialize output vector or invalid variable id in block Read Multiple Reals

Code	Nº	Explanation
err_vblk_mult_varset	681	Error in the connections for block Write Multiple Bits/Write Multiple Reals or input vector different from input variables or variable not user writable
err_vblk_pid_static	682	Unable to subscribe autotune in block PID
err_vblk_quatctrl	683	Set of configurable variables cannot be 0 or outside their range in block Quaternion Control
err_vblk_senstp	685	Error in pressure sensor block, could be that the selected pressure sensor is invalid in the current hardware or that the configured variance is negative or zero
err_vblk_sengnss	686	Error for block GNSS sensor
err_vblk_ekfpos	687	Error for block EKF position
err_vblk_ekfvel	688	Error for block EKF Velocity
err_vblk_ekfmis	689	Error for block EKF Misalignment
err_vblk_drnmis	690	Error for block EKF GNSS compass
err_vblk_senrel	691	Error for block Relative position (Sensors)

Code	Nº	Explanation
err_vblk_ekfdem	692	Error for block EKF Terrain Height
err_vblk_senmag	693	Error in magnetometer sensor block, the selected might be invalid in your current hardware or the configured variance is negative or zero
err_mdg_gain	694	Error for block Madgwick Gain Computer
err_vblk_senalt	696	Error for block Altimeter
err_vblk_ekfalt	697	Error for block EKF Altitude
err_vblk_ekfvdn	698	Error for block EKF Velocity Down
err_vblk_nav	699	Error for block Navigation
err_e2acc	700	Error for variance increment due to high acceleration
err_vblk_ekfsplit	701	Error for block EKF Split
err_vblk_fft	703	Error ID for block FFT
err_vblk_ecu	705	Error ID for block ECU control
err_vblk_fuzzy	706	Error ID for block Fuzzy Logic Controller
err_vblk_guidance	707	Input of guidance block could not be connected
err_vblk_sysid	709	Error ID for block System Identification

Code	Nº	Explanation
err_cex_pwm	710	Error ID for CEX pwm arbitration, src ID greater than pulses array
err_cex_esc_tm	711	Error ID for CEX ESC period
err_cex_mcu_tm	712	Error ID for CEX MCU period
err_vblk_climb	713	Incorrect climb block operation
err_vblk_leg	714	Incorrect leg block operation
err_flyto	715	Incorrect fly to command (non-existing patch)
err_vblk_approach	716	Incorrect approach block operation
err_vblk_yawing	717	Incorrect yawing block configuration
err_vblk_siggen	718	Incorrect signal generation configuration
err_vblk_pnav	719	Incorrect PNAV guidance configuration
err_vblk_genex	720	Incorrect GENEX guidance configuration
err_vblk_modpnav	721	Incorrect ModPNAV guidance configuration
err_blk_lib	722	Incorrect library
err_vblk_ewma	723	Incorrect EWMA block configuration

Code	Nº	Explanation
err_uarray_resize	724	Incorrect uarray resize
err_oprvar	725	Incorrect operation/setup rvar configuration
err_block_const	726	Error in block const
err_block_posget	727	Error in block posget
err_block_pnavbase	728	Error in block pnav base
err_block_arcade0	729	Error in block arcade0
err_unescape	730	Error in escape itport
err_initial_alignment	731	The internal AHRS or EKF navigation estimation algorithm could not compute an initial orientation. Try commanding an initial yaw or adding an automation to do so
err_fft_block_disable	732	The FFT block is temporarily disabled in this version
err_vblk_acclim	733	Error in block acceleration limiter
err_ewma_avgvar	734	Error in EWMA average/variance time constants
err_sensor_fusion	735	Time constants for sensor fusion algorithm are incorrect
err_oprng	736	Error in operation range configuration

Code	Nº	Explanation
err_oprng_check	737	Error in operation range check
err_vgeoref	738	Error in vgeoref configuration
err_notch_filter	739	Incorrect notch filter parameters
err_notch_frequency	740	Incorrect notch filter frequency
err_geoid_version	741	Incorrect geoid version in SD
err_vblk_integrator	742	Error in the connections for block Integrator
err_vblk_derivative	743	Error in the connections for block Derivative
err_wrapper_ref	744	Incorrect envelope range (minimum must be less or equal than maximum)
err_sensor_fusion_sel	745	Selected gyroscopes or accelerometers are invalid in this hardware or the default sensor is not active
err_volume_id	746	Incorrect volume identifier
err_fload_missing	747	Detected missing file at fload blocking
err_hi_3210_rx_cfg	748	Incorrect HI-3210 RX configuration
err_mixer	749	

Code	Nº	Explanation
		Incorrect mixer block configuration or it does not fit in memory
err_scheduler_data	750	Incorrect data size for scheduler block
err_asc	751	Incorrect configuration of ASC block
err_scheduler	752	Incorrect configuration of scheduler block
err_aacg	753	Incorrect data size for mixer block
err_mat2quat	754	Incorrect input to matrix to quaternion block
err_quat2mat	755	Incorrect input to quaternion to matrix
err_wrench_frame	756	Incorrect inputs to the wrench frame block
err_ffc_3d_block	757	Incorrect configuration of ffc3d block
err_srv_def_limits	758	A default position is not within X limits for servo actuator
err_pfield_file	759	Error in loading the saved fields
err_vblk_wind	760	Invalid configuration for wind estimation block

Code	Nº	Explanation
err_vblk_senqinf	761	Invalid configuration for dynamic pressure sensor block
err_vblk_code_size	762	External code block: Size greater than maximum allowed (64KW)
err_vblk_code_empty	763	External code block empty. No code has been loaded
err_vblk_code_ptr	764	External code block: Invalid pointer detected
err_vblk_code_inputs	765	External code block: Inputs read error
err_vblk_code_outputs	766	External code block: Outputs write error
err_vblk_ekfadapter	767	Incorrect configuration in custom EKF adapter
err_vblk_compiledsil	768	Tried to use the compiled code block on a SIL configuration
err_event_log	770	Invalid Event-Driven Log Fields configuration
err_onboard_log	771	Invalid On-Board Low Rate Log Fields configuration
err_fast_log	772	Invalid Fast Log Fields configuration
err_updt_magfield	773	Magnetic field's partition not updated correctly

Code	Nº	Explanation
err_updt_geoid	774	Geoid's partition not updated correctly
err_op_var_def_val	775	Operation variable default value outside of range
err_arbitration	10000	Error ID for Arbitration cfg
err_arbitration_can	10001	Error ID for Arbitration_can cfg
err_arbitration_can1	10002	Error ID for Arbitration_can cfg
err_arb_cfg0	10003	Error ID for Arb cfg preferred ap oor
err_arb_cfg1	10004	Error ID for Arb cfg method oor(out of range)
err_arb_cfg2	10005	Error ID for Arb cfg tmin oor
err_arb_cfg3	10006	Error ID for Arb cfg hysteresis oor
err_ap_nvars	10007	Error ID for Autopilot nvars oor
err_apcfg_nvars	10008	Error ID for Autopilot cfg nvars oor
err_jetibox	10009	Error ID for sci identifier of Jetibox cfg oor
err_jetibox_fmsgcmd	10010	Error ID for jetibox fmsg cmd oor
err_arb_init_time	10011	Error ID for Arbiter Power Init Time less than 0
err_arb_varcfg	10013	

Code	Nº	Explanation
		Incorrect arbiter variable configuration
err_hs_base_can_id	15000	High speed telemetry invalid Base CAN Id
err_hs_tm_nvars	15001	High speed telemetry number of variables too big
err_vmc_motor	20000	Motor cfg is not valid
err_vmc_control_mode	20001	Control mode is invalid
err_vmc_encoder_nbits	20002	Number of bits for encoder is invalid
err_mc_vmotor	20003	Virtual motor cfg invalid
err_mc_smo	20004	Slide Mode Observer cfg invalid
err_mc_control	20005	Control cfg invalid
err_mc_fault_detection	20006	Invalid fault detection limits
err_mangle_rate	20007	Invalid filter time constant
err_low_pll	20008	Invalid cut-off frequency
err_mc_main	20009	Invalid real time frequency
err_range_check	20010	Invalid range definition
err_ext_sens	20011	Invalid external sensor configuration
err_press_dev	20012	

Code	Nº	Explanation
		Invalid pressure sensor configuration
err_press_dps310	20014	Invalid pressure sensor Internal 2 configuration
err_press_hsc	20015	Invalid pressure sensor Internal 0 configuration
err_press_ms56	20016	Invalid pressure sensor Internal 1 configuration
err_invalid_cal_table	20017	Invalid number of entries in calibration table
err_mag_lis3mdl	20018	Invalid magnetometer LIS3MDL configuration
err_mag_hscdtd	20019	Invalid magnetometer HSCDTD008A configuration
err_mag_mmc5883ma	20020	Invalid magnetometer MMC5883MA configuration
err_mag_rm3100	20021	Invalid magnetometer RM3100 configuration
err_ex_ussa76_cmd	20022	Invalid period of external USSA76 command
err_cfgmr_length	31999	Unexpected size of PDI or command
err_check_test	65535	Error ID for given pdi check

List of File System Errors

Integer variable File system status (UVar 96) represents several **DFS2 FS-related error states**, as each of its 16 bits indicates a specific error condition.

BIT	15	14	13	12	11	10	9	8	7	6	5	4	3	2	1	0
STATUS		0/1	0/1	0/1	0/1	0/1	0/1	0/1	0/1	0/1	0/1	0/1	0/1	0/1	0/1	0/1

File system status

Below is a list of potential error conditions associated with each bit:

ID	Error description
0	Index sector is not correct (1 if not correct - 0 if correct)
1	Error initializing SD (1 if not correct - 0 if correct)
2	Num partition bigger than allowed (1 if bigger - 0 if not)
3	No more descriptor available (1 if not available - 0 if available)
4	The descriptor of a file was not correct (CRC failed) (1 if fail - 0 if not)
5	The new descriptor couldn't be created (1 if not created - 0 if created)
6	Error updating the file size (1 if error updating - 0 if no error)
7	Error formatting because of system description size (1 if error formatting - 0 if not)

ID	Error description
8	Error formatting driver not initialized (1 if error formatting - 0 if not)
9	Error formatting maximum partition number overpassed (1 if error formatting - 0 if not)
10	Error formatting not able to write index sector (1 if error formatting - 0 if not)
11	Error formatting partition not enabled (1 if error formatting - 0 if not)
12	Error writing the index for the log controller (1 if error formatting - 0 if not)
13	File was destroyed but was not closed or had pending requests (1 if not closed or pending requests - 0 if closed or had no pending requests)
14	Unable to read a sector (1 if unable - 0 if able)

Firmware Changelog

This section presents the changes between firmware versions of Veronte Autopilot 1x.

8.2

This section presents the changes between the previous firmware version of Veronte Autopilot 1x, **v.7.8.18**, and this firmware version, **8.2**. For further details, please consult the [Service Bulletin nº 00026](#).

Added

- Extended support for DRx

Step by step

This section explains the main steps to be followed to create a new **PDI configuration** that adapts the Veronte Autopilot 1x performance to the aircraft and mission requirements. The process followed from the creation of a configuration until it is operated in flight with Veronte Autopilot 1x is divided into 2 phases:

1. **Create a configuration** that suits the expected performance of the aircraft and validate it.

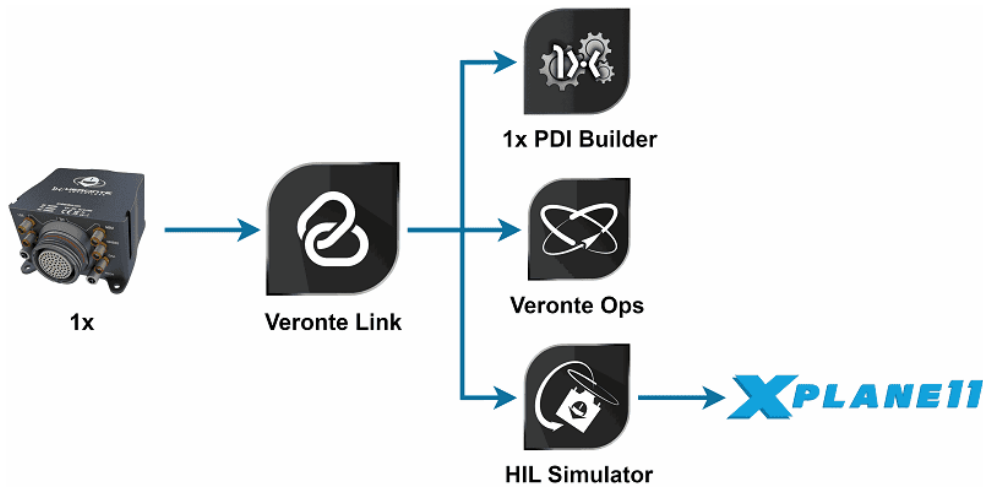
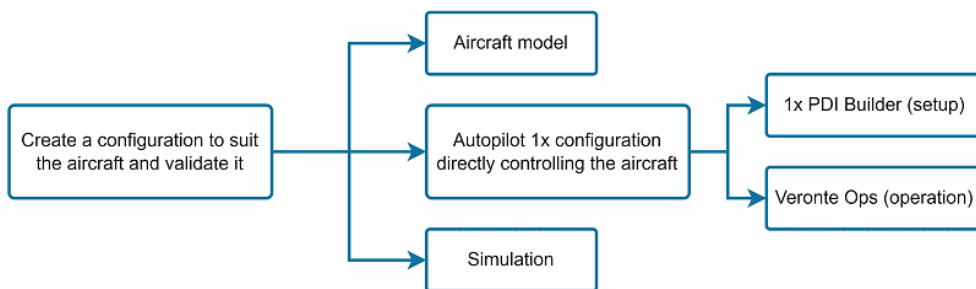

2. **Real operation**

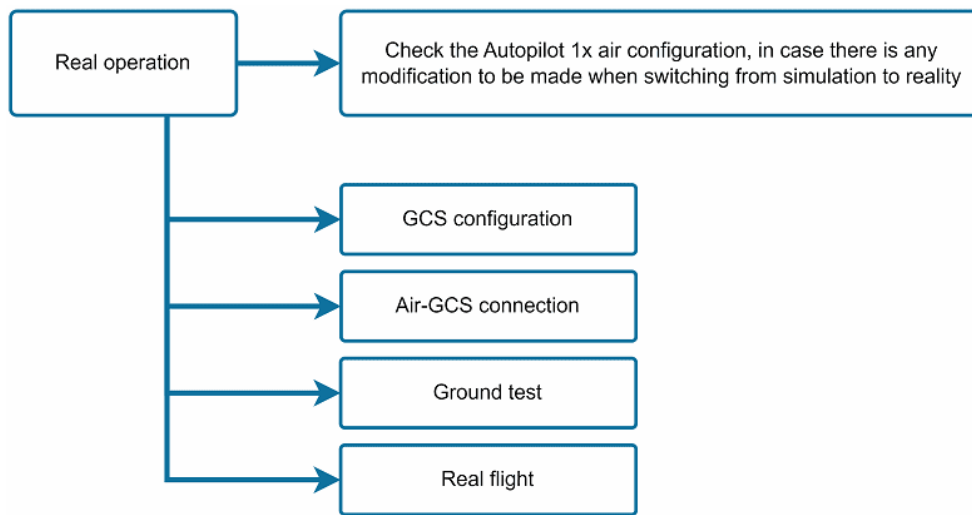

All Kinds of Vehicle

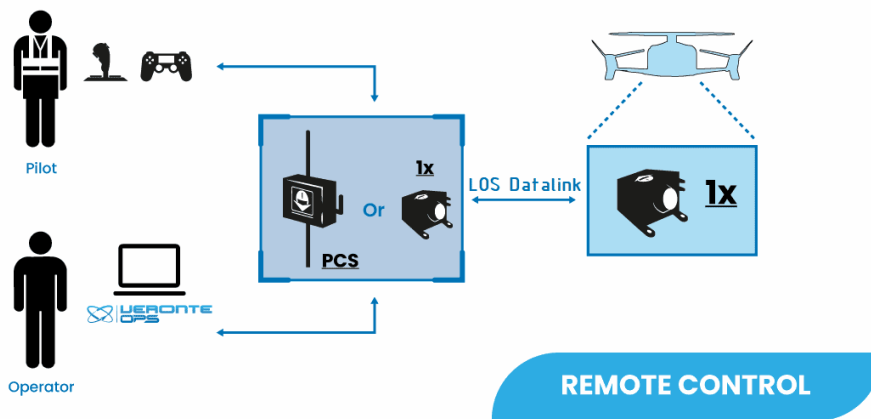

VTOL

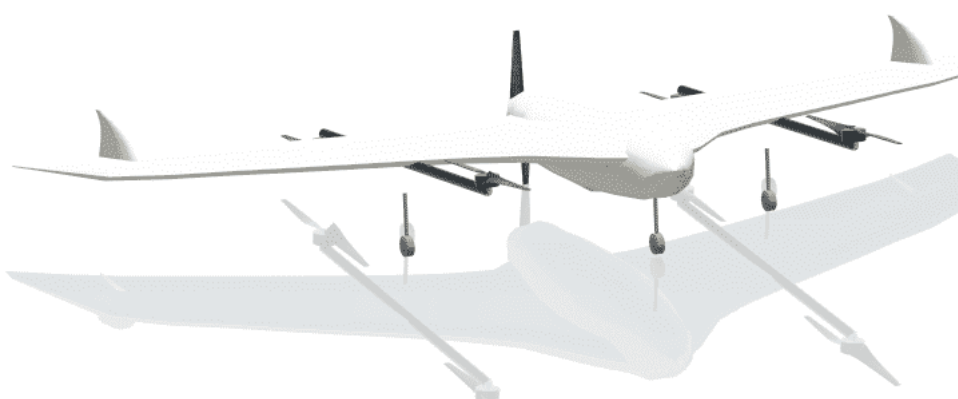

Follow the steps described in each one of the following sections to be able to:

- Adapt a basic Veronte Autopilot 1x configuration to a VTOL aircraft ⇒ [1x Air configuration](#).

- Perform HIL simulations to validate the aircraft model and configuration ⇒ [Simulation](#).
- Create the Ground Control Station (GCS) configuration that will be part of the standard operation layout ⇒ [1x GCS configuration](#).
- Establish the communication/connection between both parts of the standard operation layout, the GCS and Autopilot 1x in the VTOL ⇒ [Air-GCS connection](#).
- Ground test to check that all system and electronics work and behave correctly before flight.
- Real operation.

However, first it is necessary to define some aspects of the aircraft model to be taken into account when adjusting the configuration to the expected performance of the aircraft.

Aircraft specifications

This section defines the main geometrical and operational specifications of the Embention VTOL aircraft.

All Kinds of Vehicle

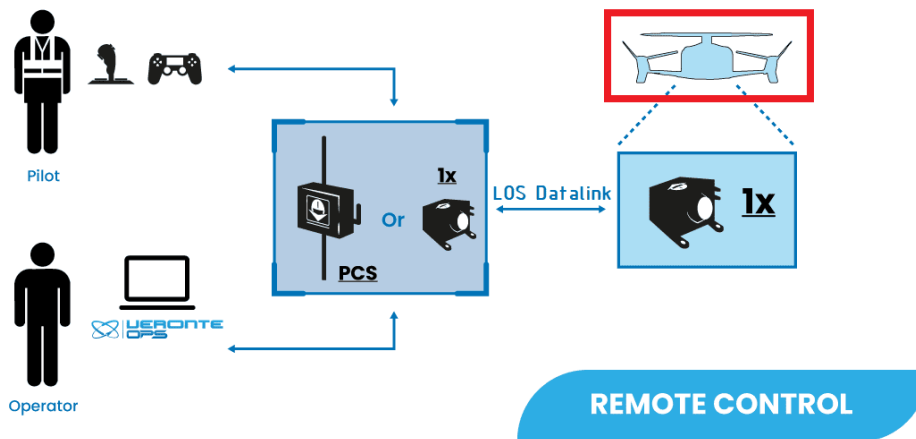

Embention VTOL Aircraft

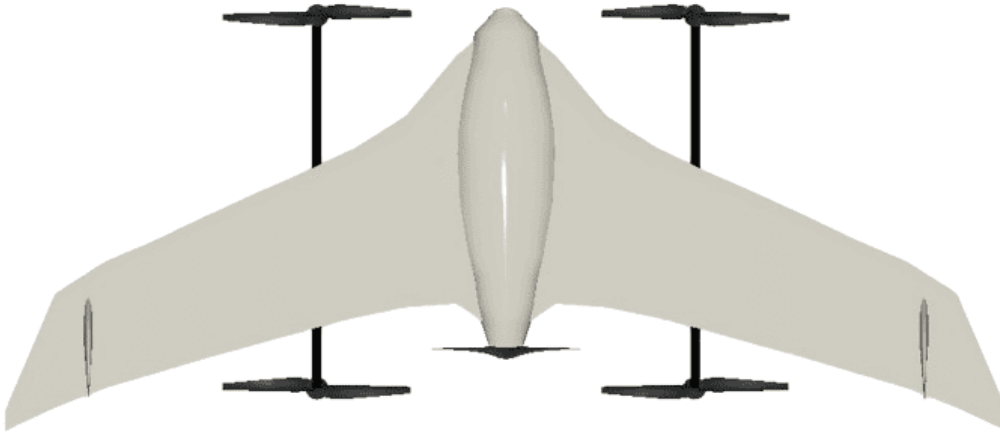

- **Name:** Embention VTOL aircraft
- **Aircraft type:** VTOL
 - The VTOL is composed of **4 vertical propellers** for quadcopter configuration and **1 pusher motor** for Fixed-Wing (FW) configuration.
 - The frame is a **flying wing** composed of **two elevators and two vertical fins without rudder**.

Explanation

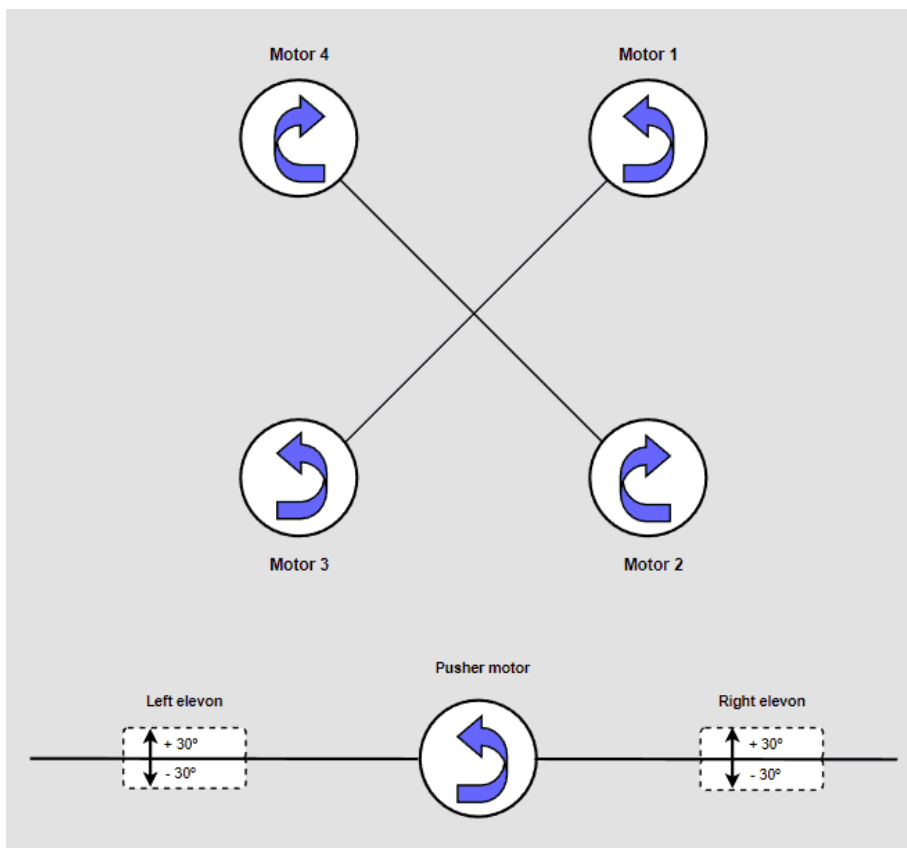

Rotation

Geometric Specifications

Parameter	Value
Weight	4.2 Kg
Longitudinal CG location	0.38 m
Vertical CG location	0.0 m
Max. Deflection Right Elevator	$\pm 30^\circ$
Max. Deflection Left Elevator	$\pm 30^\circ$

Airfoil

Component	Specification
Wing	MH60
Vertical fins	NACA 0009

Engine Specifications

Parameter	Value
Number of propellers	5
Rotation propeller 1	CCW
Rotation propeller 2	CW
Rotation propeller 3	CCW
Rotation propeller 4	CW
Rotation propeller 5	CW
Propeller 1-4 (vertical) diameter	15x5.5

Parameter	Value
Propeller 5 (pusher) diameter	12x6e

Operational Specifications

Parameter	Value
Stall speed (no flaps)	15 m/s
Cruise speed	25 m/s
Maximum speed	30 m/s

1x Air configuration

This section defines the Autopilot 1x configuration that will control the aircraft, i.e., that will be inside the VTOL.

All Kinds of Vehicle

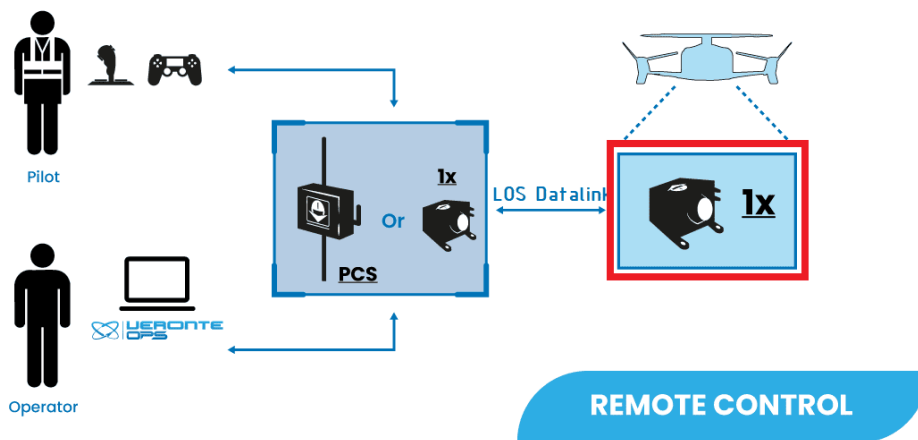

This is divided into 2 parts:

- **1x PDI Builder configuration:** The creation of the 1x configuration in the **1x PDI Builder** app.
- **Operation:** The definition of the operation and mission of the aircraft in **Veronte Ops**.

1x PDI Builder configuration



1x PDI Builder

1x PDI Builder is the main configuration tool to adapt a Veronte Autopilot 1x to a specific vehicle, including user-defined communication protocols. 1x PDI Builder allows the user to change the configuration inside the autopilot, create new configurations or work on a configuration offline.

Note

For more information about the installation and use of 1x PDI Builder, visit the [1x PDI Builder user manual](#).

Once the application is installed, the user has two options to configure the autopilot. On the one hand, the user can download one of the templates provided by Embention that best suits his platform, on the other hand, the user can configure the Autopilot 1x from scratch.

Tip

It is highly recommended to follow the first option, which is explained throughout this step-by-step.

1. Open the 1x PDI Builder application and select the connected Autopilot 1x:



- 2. Select the **Open 1xVeronte** option to directly edit the configuration loaded in the 1x:

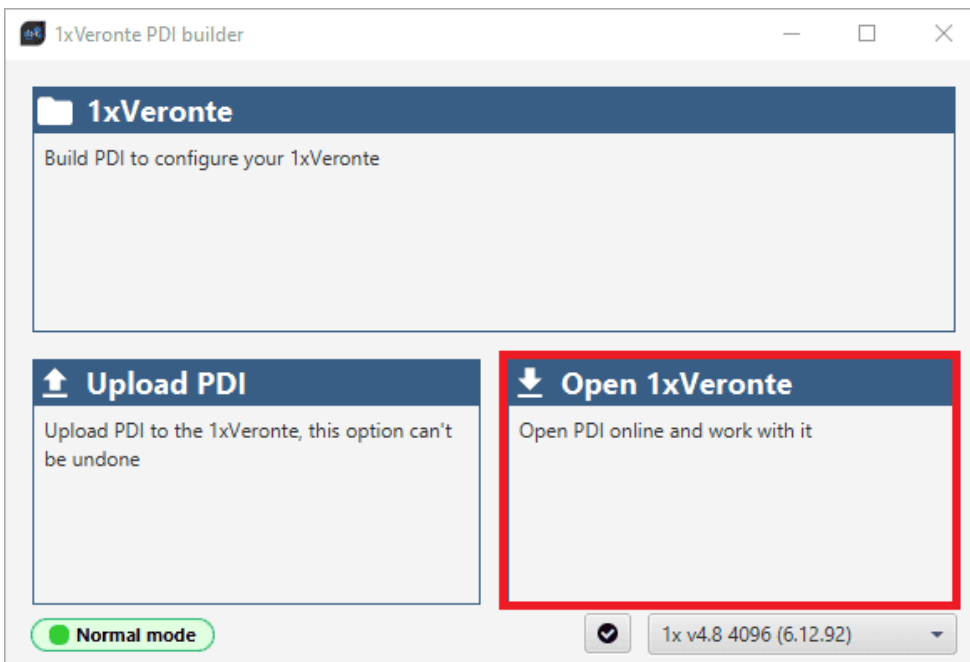

- 3. Click the **Import PDI from repo** button in the menu bar:

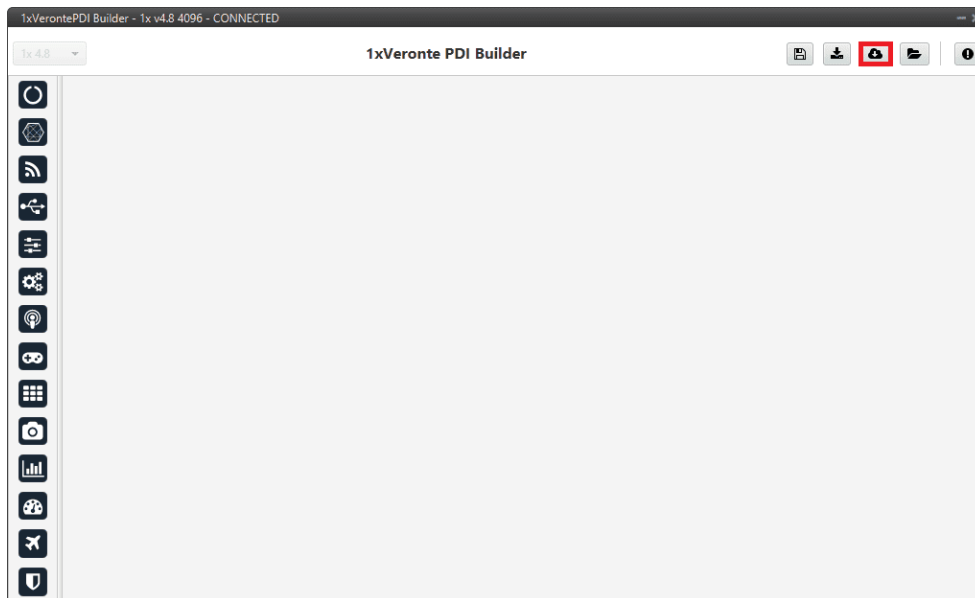

4. Select the **VTOL** template and import it:

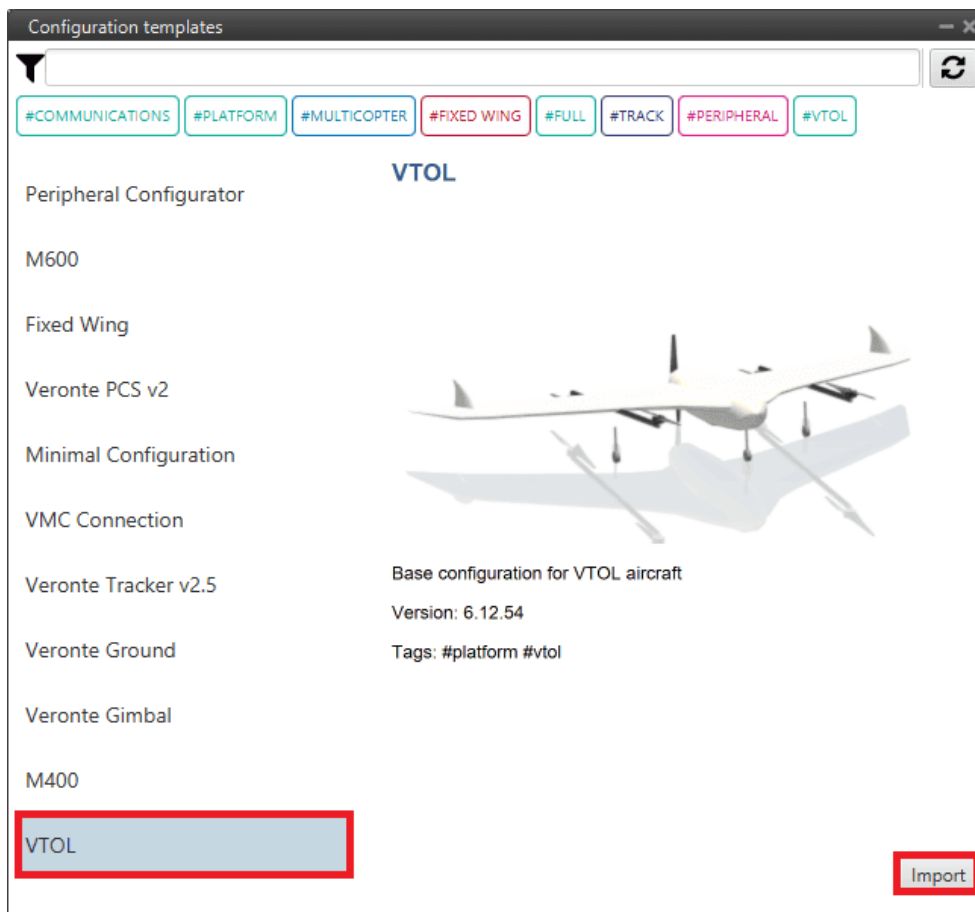

5. Finally, click the **Save and close** button to save the downloaded template to the connected Autopilot 1x:

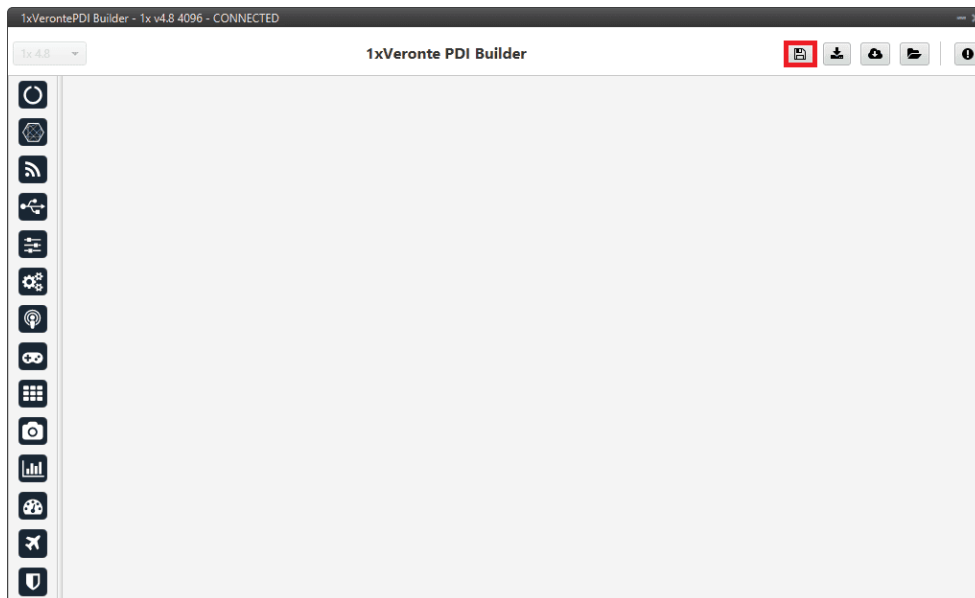

Note

In order to save the configuration, Veronte Autopilot 1x must enter in maintenance mode. Then, after saving any changes, Autopilot 1x will RESET and 1x PDI Builder software will consequently close. For more information, visit the [Configuration](#) section of the **1x PDI Builder** user manual.

For a basic configuration of the Autopilot 1x, the following parameters must be configured:

- [Name & attitude](#)
- [Actuators & SU Matrix](#)
- [Modes & Phases](#)
- [Block Programs](#)
- [Automations](#)
- [Sensors](#)
- [HIL configuration](#)
- [Checklist](#)

Name & Attitude

Unit name

To start a configuration, it is necessary to define a name for the configuration and it is recommended to be in **PDI mode** while performing the configuration and simulations.

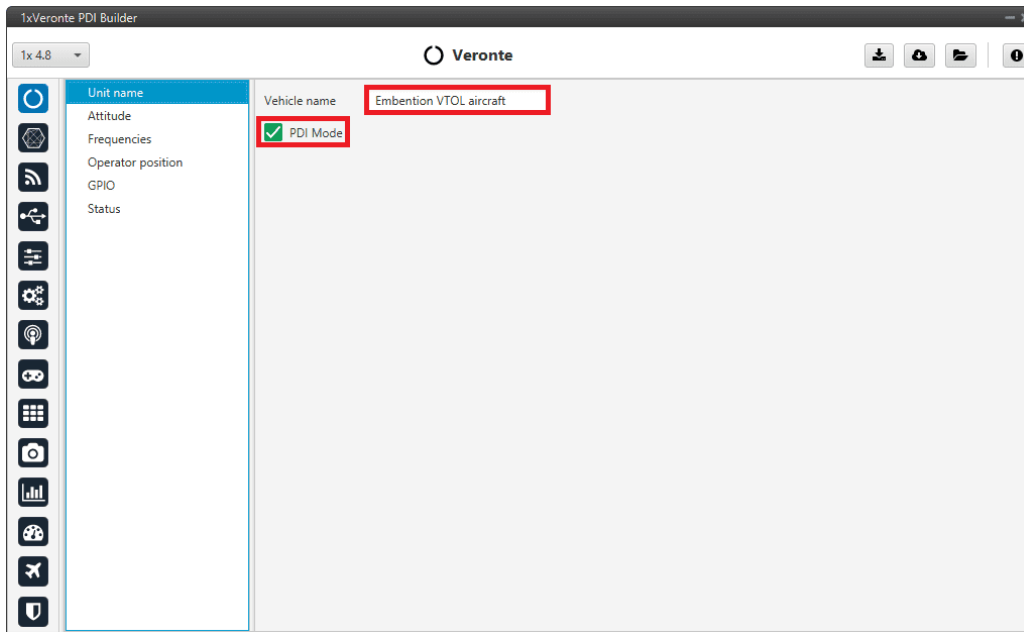

Unit name & PDI mode

Danger

PDI mode is intended for development purposes since it allows flight phase changes with system, sensor and PDI errors.

It is highly recommended to limit its use to simulation and ground testing of peripherals during the development phase.

Therefore, as it is not advisable to operate in PDI mode, please disable it once the configuration is finished and intended to be used in flight.

For more information, visit the [Unit name - Veronte](#) section of the **1x PDI Builder** user manual.

Attitude

The autopilot orientation corresponds to a rotation of 180° around the Z-axis on the aircraft axes.

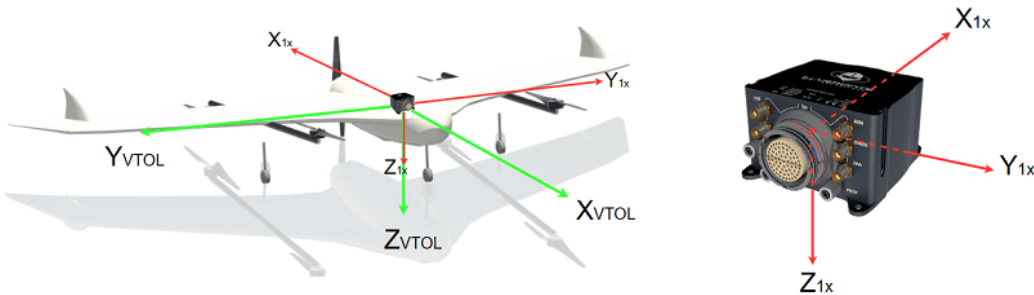

Orientation

Note

Since it is a simple orientation to define, we can do it directly from the aircraft schematic.

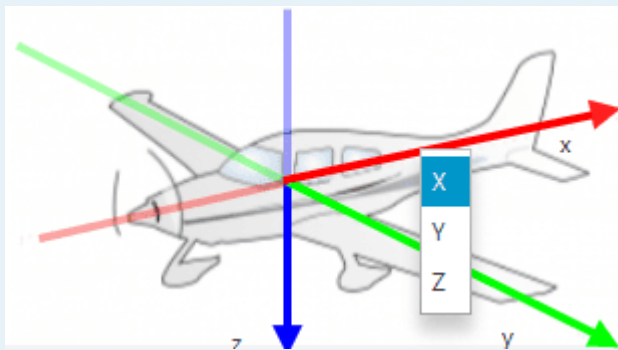

Change orientation

Regarding the center of gravity, Autopilot 1x is located at the center of gravity, so the distance to it is zero.

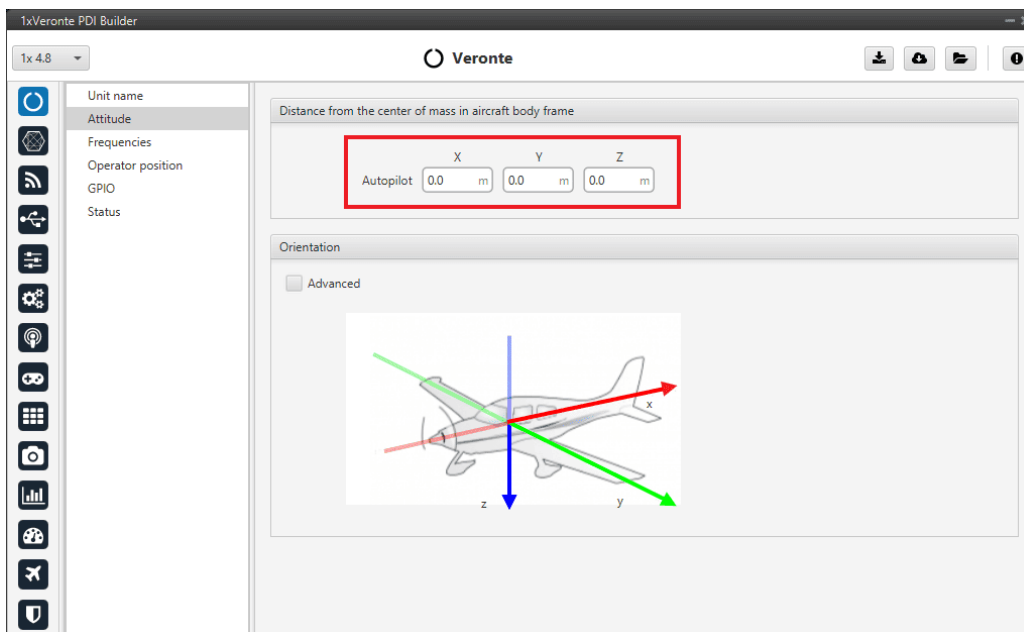

Embention VTOL aircraft Attitude

For more information, visit the [Attitude - Veronte](#) section of the **1x PDI Builder** user manual.

Actuators & SU Matrix

GPIO to PWM connection

Servos and ESC use PWM signals for control. Therefore, since all PWM/GPIO pins are configured as GPIO output by default, it is necessary to change them to PWM output (as many pins as servos/actuators).

Note

For the Embention VTOL aircraft 7 PWM output pins have been configured. Each of these pins will control the movement of each of the 7 servo/actuators available on the platform.

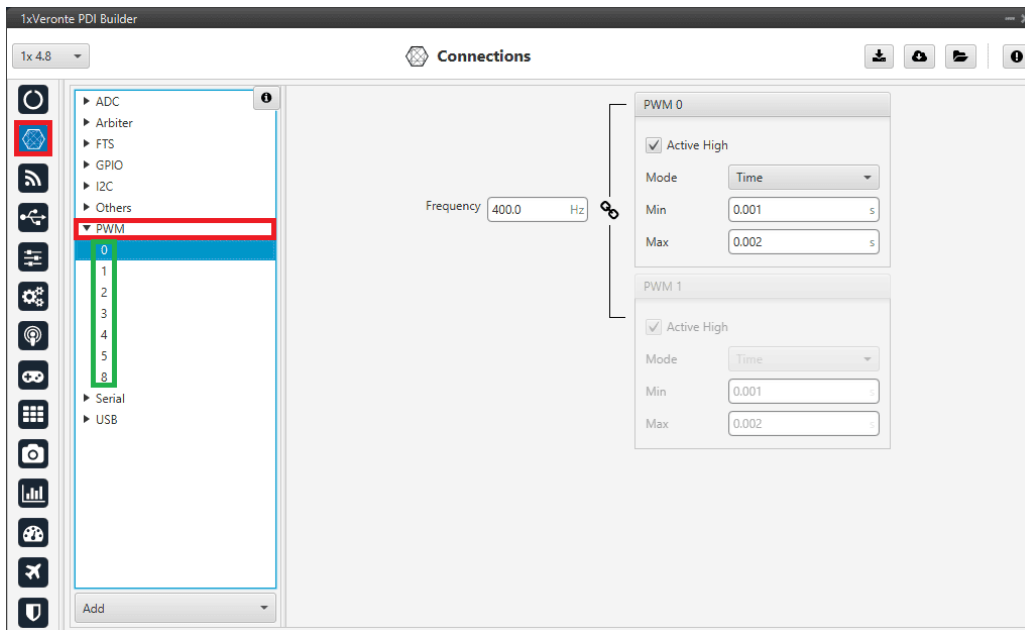

PWM connections

For detailed information on how to set up a **GPIO connection to a PWM connection**, visit the [PWM - Connections](#) section of the **1x PDI Builder** user manual.

Actuators

The following table shows the correspondence between the actuators of the Embention VTOL aircraft and the servos:

Servo	Servo 0 (S0)	Servo 1 (S1)	Servo 2 (S2)	Servo 3 (S3)	Servo 4 (S4)	Servo 5 (S5)	Servo 6 (S6)
Actuator	Motor 1	Motor 2	Motor 3	Motor 4	Pusher motor	Right elevator	Left elevator

Motor Numbering

In general, the numbering will be defined by the customer. In this case, the motors are numbered **clockwise**, with number 1 being the motor located to the right of the front of the vehicle.

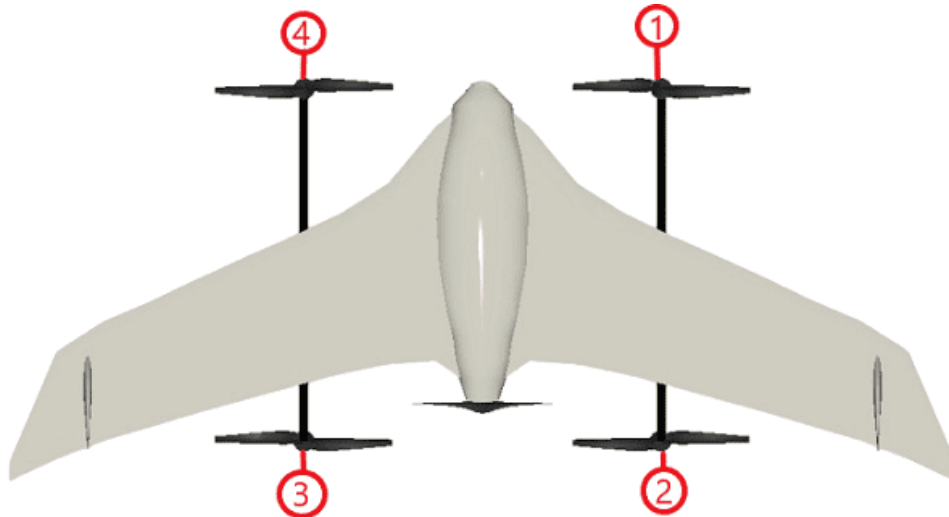

Motor numbering

To define the actuators position, users must first establish a criterion, in the Embention VTOL aircraft it is as follows:

- **Motors:** It is set in the range **0 to 1**.
 - At minimum position (0% RPM) → **0**
 - At maximum position (100% RPM) → **1**
- **Linear actuators:** Defined by angle, from -30° to $+30^{\circ}$.

Note

The range of deflection does not have to be symmetrical, although in this case it is.

Next, the position of the actuators must be defined with the [Actuator block](#) of the **1x PDI Builder** app. The steps below summarize the configuration to be performed by the user for this block:

1. Go to **Block Programs menu** → click on "**Launch Editor**".

- Go to "**Control to servo**" program → double-click on the **Actuator block** to start configuring it.

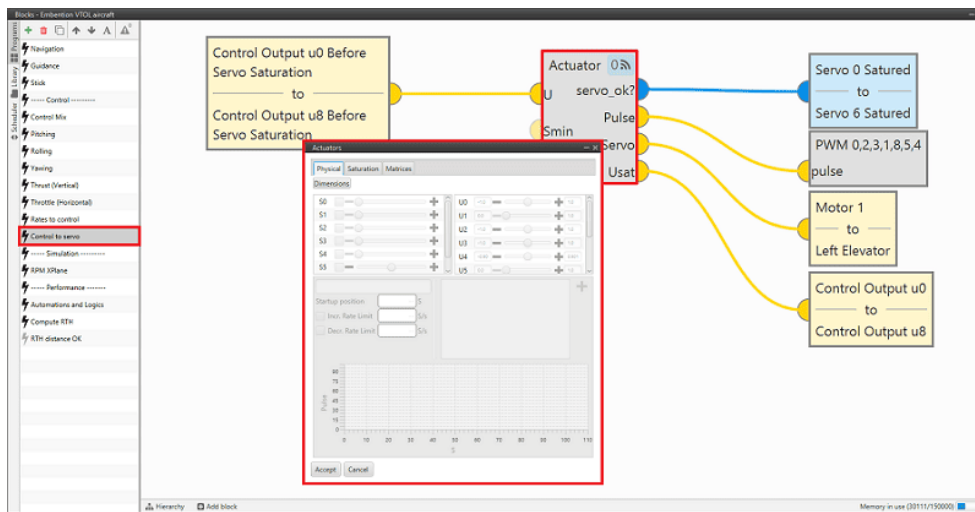

Control to servo

- Define the dimension of the matrix formed by the servos and the control outputs to be configured.

For the Embention VTOL aircraft, a 7x9 matrix has to be defined, since there are 7 servos on the platform and 9 control outputs are required.

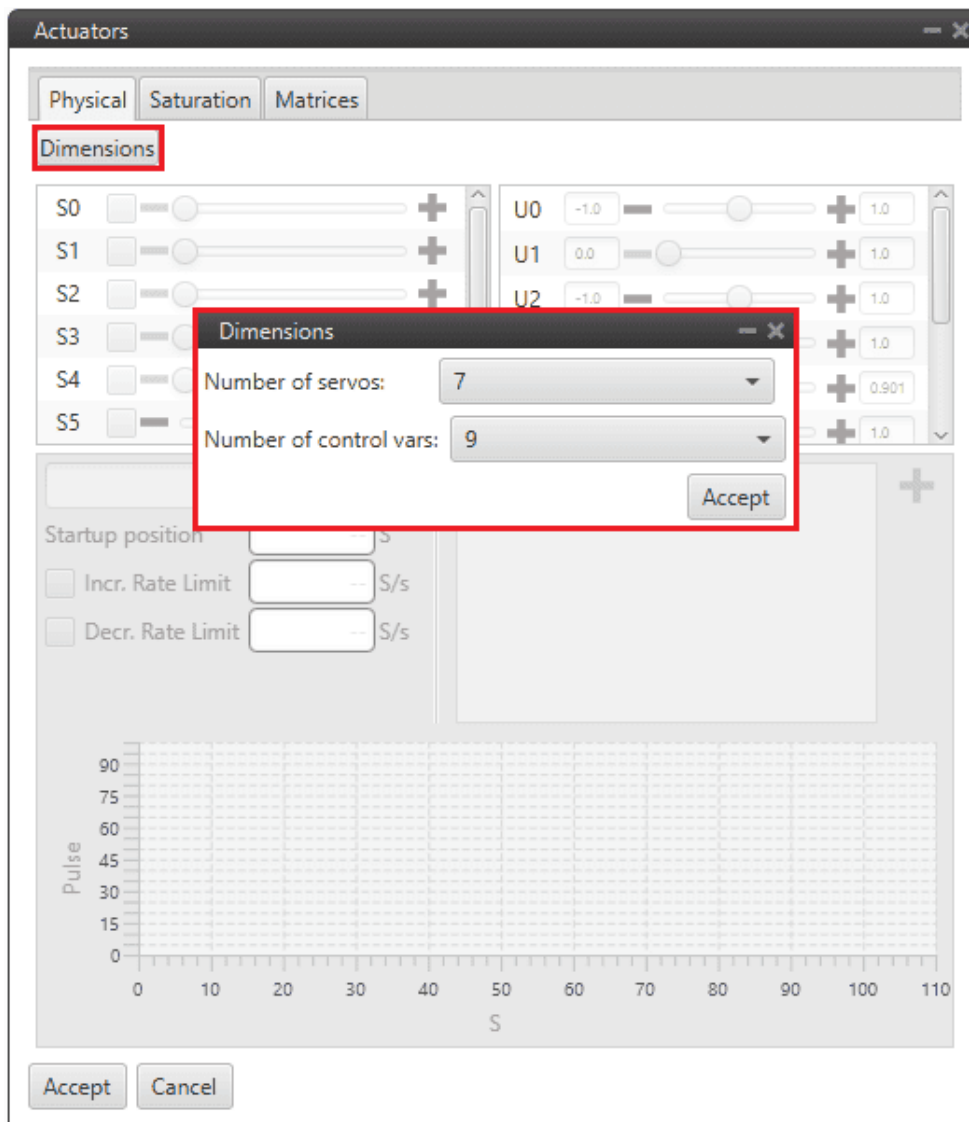

Dimensions

Note

Once the control outputs have been defined, the configuration of the block programs can begin. These configurations determine the Autopilot's behavior in the automations that allow it to control the aircraft.

4. For each servo, define the servo position of the servo that responds to the PWM connection pulse, i.e., we try to find the PWM pulse for which the servo position is the desired one.

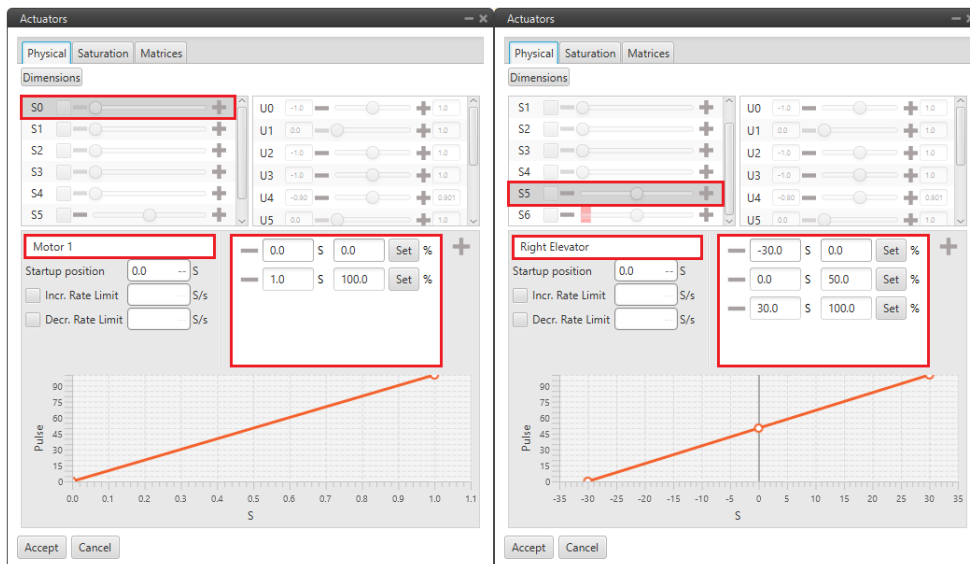

Motor 1 / Right Elevator actuator definition

Note

The servo position does not have to be symmetrical. In the case of Embention VTOL Aircraft, we have the example of the servo corresponding to the Left Elevator (S6).

The screenshot shows the 'Actuators' configuration window. The 'Physical' tab is selected. Under 'Dimensions', actuators S1 through S6 are listed. S6 is highlighted with a red box. Below this, the configuration for 'Left Elevator' is shown. It includes a 'Startup position' of 0.0 S, and three rate limit settings: -30.0 S (100.0%), 0.0 S (50.0%), and 30.0 S (9.0%). The 9.0% value is highlighted with a red box. Below the configuration is a graph showing 'Pulse' vs 'S' with a red curve and a red box around the 'S' label on the x-axis.

Left Elevator actuator definition

For this S6, the PWM pulse should allow to achieve a deflection of $\pm 30^\circ$. For the $+30^\circ$ deflection, it is achieved with 9% of the PWM pulse, unlike the Right Elevator (S5) which was obtained with 100%.

Important

The variable **S** in the graph is a position that can represent any variable desired by the user (**rad**, **°**, **RPM**).

⚠ Important

A complete explanation of the use of the **Actuator block** in the **Control to servo program** can be found at [Control to servo - Block Programs](#) section of this manual.

SU Matrix

SU matrix contains the relationship between each actuator (S) and its control output (U). Although it is also possible to define the US matrix (inverse of the SU matrix), the SU matrix is usually defined because the visualization of the movement is more intuitive this way.

In the SU matrix of the Embention VTOL aircraft, each of the 9 defined control outputs represents an aircraft control action, as can be seen in the following table.

Control output	u0	u1	u2	u3	u4	u5	u6	u7
Action	Pitch (Quad)	Thrust (Vertical)	Roll (Quad)	Yaw (Quad)	Pitch (Plane)	Throttle (Horizontal)	Roll (Plane)	Adv Y (Ri)

These actions can be performed thanks to the variation of the position of the 7 platform servos already mentioned.

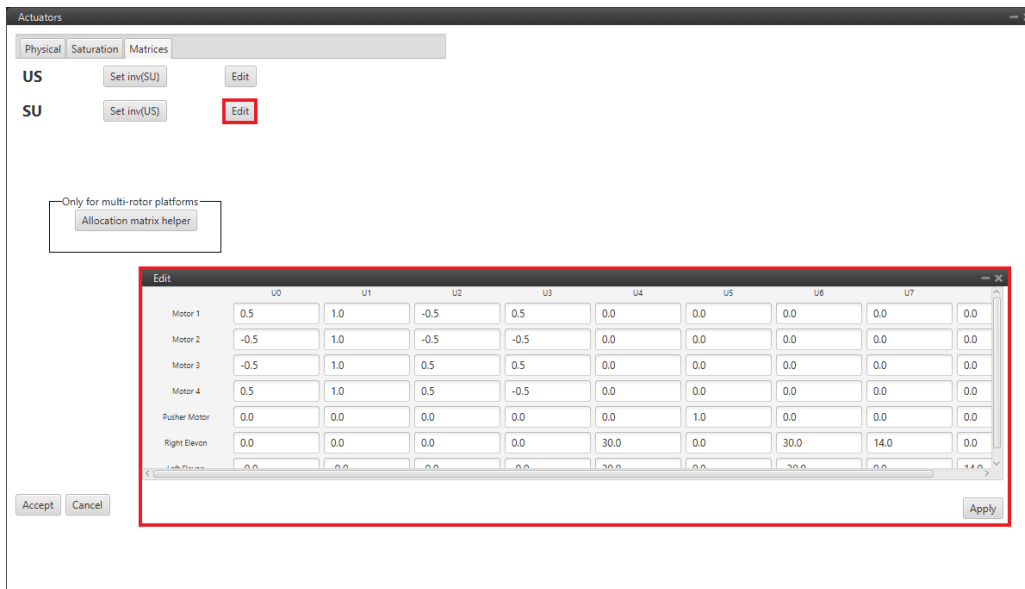

SU Matrix

Sign Convention

- Positive angle means deflection upward or to the right.
- Negative angle means deflection downward or to the left.

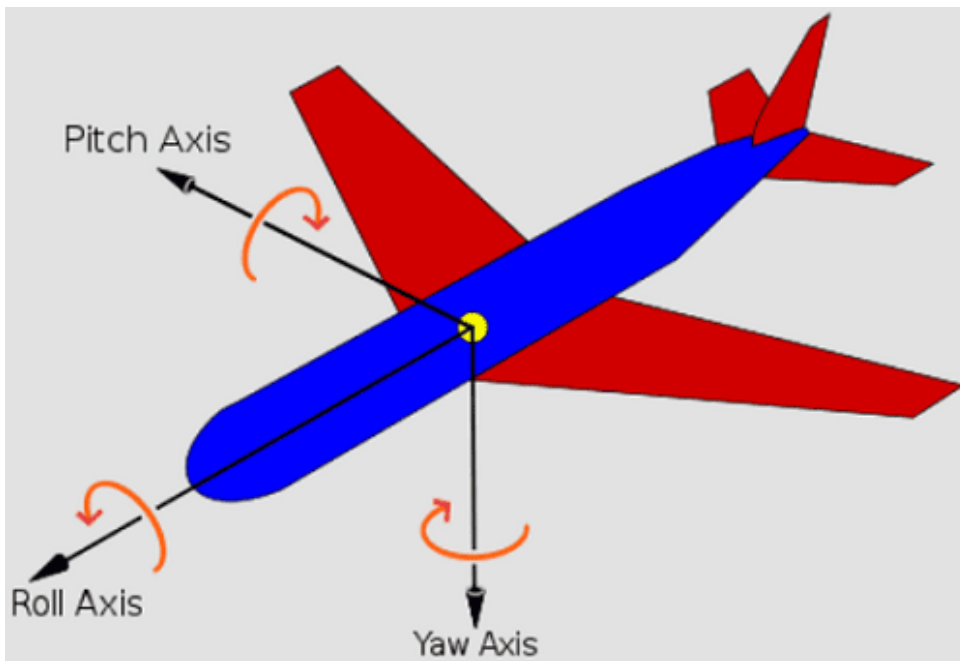

u0 -- Pitch (Q)

Servos	u0
Motor 1	0.5
Motor 2	-0.5
Motor 3	-0.5
Motor 4	0.5
Pusher motor	0.0
Right elevator	0.0
Left elevator	0.0

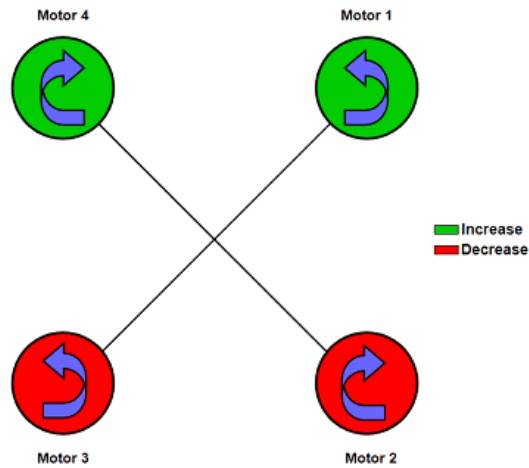

u1 -- Thrust (vertical)

Servos	u1
Motor 1	0.5
Motor 2	0.5
Motor 3	0.5
Motor 4	0.5
Pusher motor	0.0
Right elevator	0.0
Left elevator	0.0

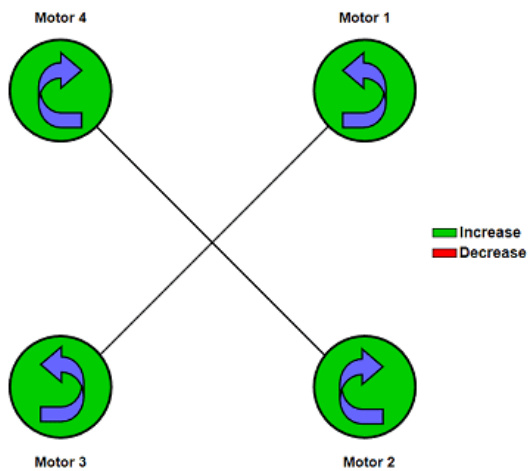

u2 -- Roll (Q)

Servos	u2
Motor 1	-0.5
Motor 2	-0.5
Motor 3	0.5
Motor 4	0.5
Pusher motor	0.0
Right elevator	0.0
Left elevator	0.0

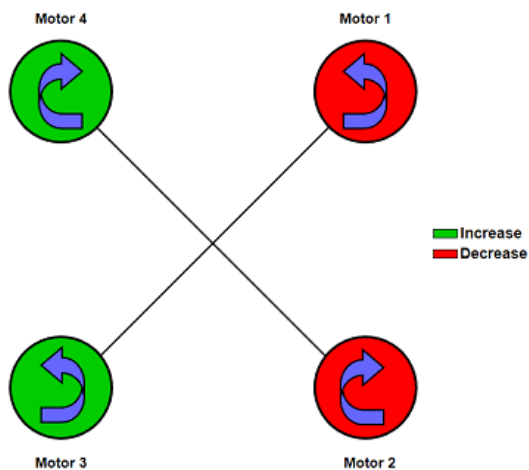

u3 -- Yaw (Q)

Servos	u3
Motor 1	0.5
Motor 2	-0.5
Motor 3	0.5
Motor 4	-0.5
Pusher motor	0.0
Right elevator	0.0
Left elevator	0.0

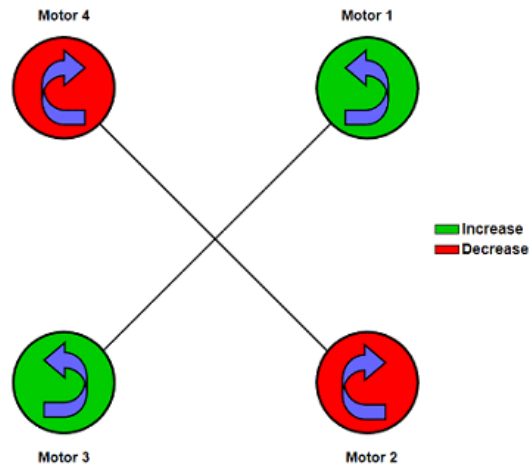

u4 -- Pitch (P)

Servos	u4
Motor 1	0.0
Motor 2	0.0
Motor 3	0.0
Motor 4	0.0
Pusher motor	0.0
Right elevator	30.0
Left elevator	30.0

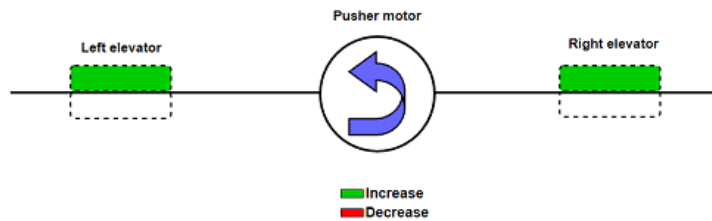

u5 -- Throttle (horizontal)

Servos	u5
Motor 1	0.0
Motor 2	0.0
Motor 3	0.0
Motor 4	0.0
Pusher motor	1.0
Right elevator	0.0
Left elevator	0.0

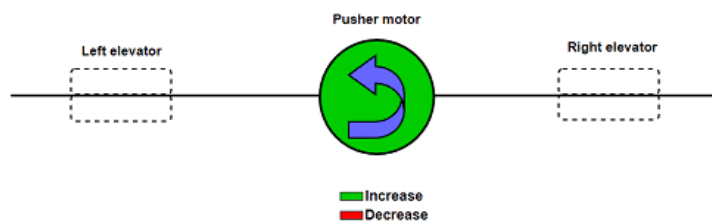

u6 -- Roll (P)

Servos	u6
Motor 1	0.0
Motor 2	0.0
Motor 3	0.0
Motor 4	0.0
Pusher motor	0.0
Right elevator	30.0
Left elevator	-30.0

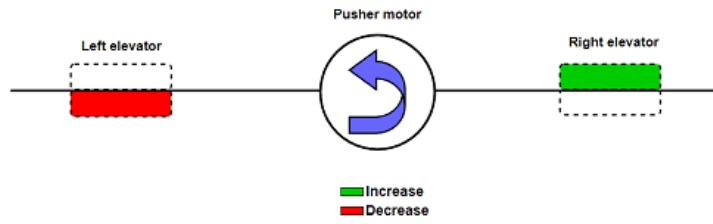

u7 -- Adverse Yaw (Right)

Servos	u7
Motor 1	0.0
Motor 2	0.0
Motor 3	0.0
Motor 4	0.0
Pusher motor	0.0
Right elevator	14.0
Left elevator	0.0

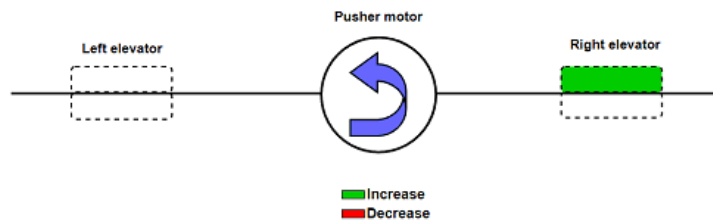

u8 -- Adverse Yaw (Left)

Servos	u8
Motor 1	0.0
Motor 2	0.0
Motor 3	0.0
Motor 4	0.0
Pusher motor	0.0
Right elevator	0.0
Left elevator	14.0

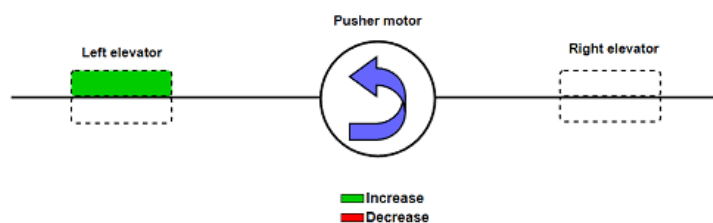

For more information, visit the [Actuator - Servos blocks](#) of the **Block Programs** section of the **1x PDI Builder** user manual.

⚠ Important

A complete explanation of the use of the **Actuator block** in the **Control to servo program** can be found at [Control to servo - Block Programs](#) section of this manual.

Modes & Phases

Modes definition

The flight modes determine who is in charge of controlling each one of the aircrafts control channels. Each of the channels represents a control output, defined by the customer in the Block Programs configuration. In the Embention VTOL aircraft these channels are linked in order to each control output of the SU matrix.

Channel	0	1	2	3	4	5	6	7	8
Control output	u0	u1	u2	u3	u4	u5	u6	u7	u8
Action	Pitch (Q)	Throttle (Q)	Roll (Q)	Yaw (Q)	Pitch (P)	Thrust (P)	Roll (P)	Adverse Yaw Right (P)	Adverse Yaw Left (P)

There are four different **control modes** and it is possible to combine them to create custom flight modes. The options available are:

- **auto**: Automatic mode.
- **rc**: Radio Control mode, i.e. manual mode.
- **arc**: Arcade mode, this could be considered as a mix between automatic and manual.
- **mix**: In this mode, it is possible to select in which step of the controller the pilot command will enter.

For more information on these control modes, visit the [Modes - Control](#) section of the **1x PDI Builder** user manual.

For each of the channels of the 4 **flight modes** defined, a control mode must be assigned to it.

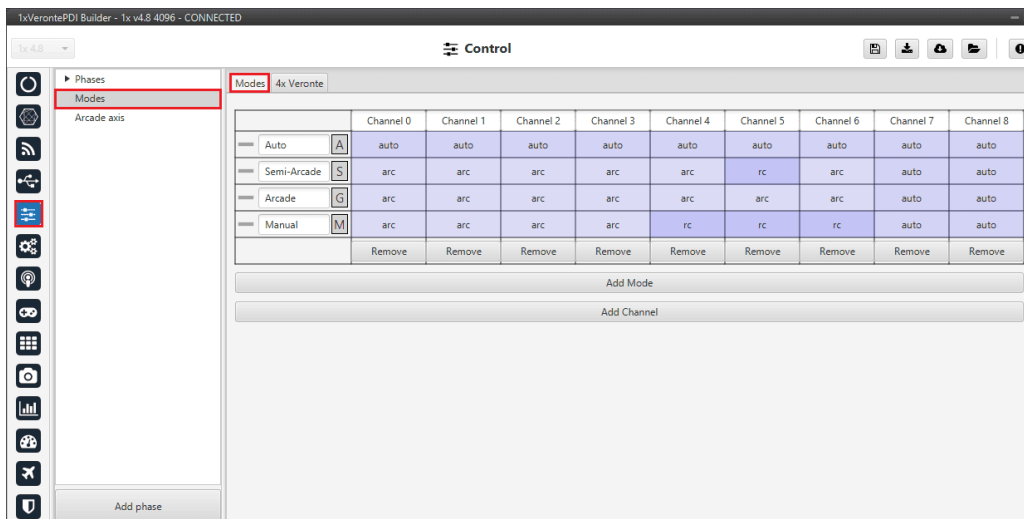

Modes definition

Note

The controls to perform the control action Adverse Yaw, correspond to channels 7 and 8 and are performed in **Auto** mode.

This is because these actions are complementary to the Roll movement, so being a correction, they must be performed automatically by the autopilot **for all flight modes**.

- **Auto flight mode** A

In this mode, all control outputs (channels) defining the aircraft performances are automatically controlled by the autopilot (auto mode).

- **Semi-Arcade flight mode** S

In this mode, the Pitch, Thrust, Roll and Yaw controls are controlled in **arc mode**. That is, the input information is sent from the pilot's stick to the autopilot, and it is the autopilot that takes over the performance. The Throttle action is controlled directly by the pilot stick in **rc mode**.

- **Arcade flight mode** G

In this flight mode, the aircraft performances are controlled in **arc mode**. So, when the pilot commands a desired pitch, roll, IAS, heading and so on, and it will be the control system that will be in charge of making the platform follow those commands.

- **Manual flight mode** M

The manual flight mode mixes **rc** control mode with **arc**:

- For the quadcopter control, **arc mode** must be defined since the pilot's stick cannot act on the motors.
- For the fixed wing control, **rc mode** can be set so that the pilot's stick acts directly on the elevators and throttle.

Phases definition

The flight phases that will control the aircraft in the different stages of the operation must be created (defined not configured).

For the operation of the Embention VTOL aircraft 12 flight phases have been defined:

1. **Standby**: All actuators are deactivated.
2. **Take-off**: Aircraft vertical take-off.
3. **Approach**: Execute approach maneuver to the runway defined for VTOL.
4. **Landing**: Aircraft vertical landing.
5. **Loiter**: Loiter at current position and altitude.
6. **Hover**: Maintain current 3D position.
7. **Hold**: Stabilize attitude and vertical speed.
8. **Cruise**: Follow defined mission.
9. **Climb**: Ascend to the loiter from the runway.
10. **Armed**: Vertical propellers run-up.
11. **Return Home**: Go to one of the pre-defined landing points and hover.
12. **Flight Control Check**: Manual check of elevators and horizontal motor.

Note

In addition to these phases, when Veronte Autopilot 1x boots up it is by default in the "**Initial**" phase.

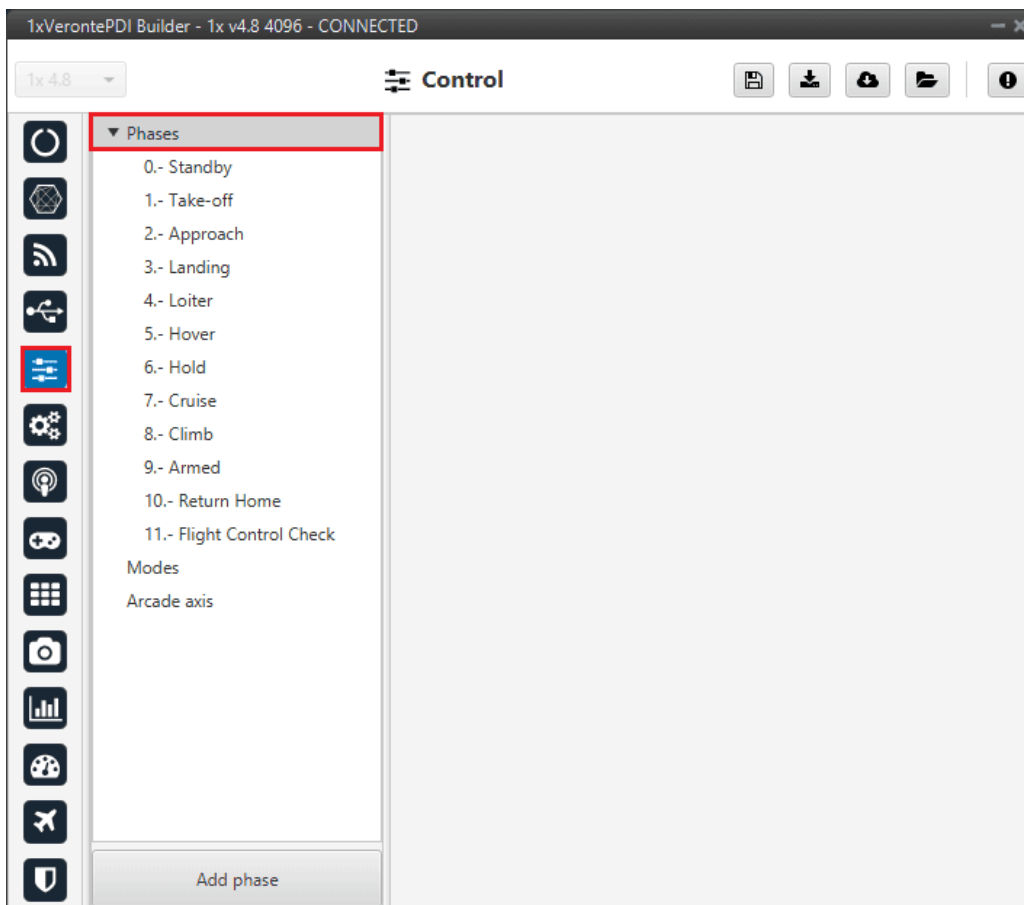

Phases definition

Note

The configuration of the flight phases (guidance and control commands) is done in the [Block Programs menu](#).

For more information, refer to the [Phases - Control](#) section of the **1x PDI Builder** user manual.

Block Programs

In this section the user can configure and develop the different programs for aircraft control, guidance, navigation, etc.

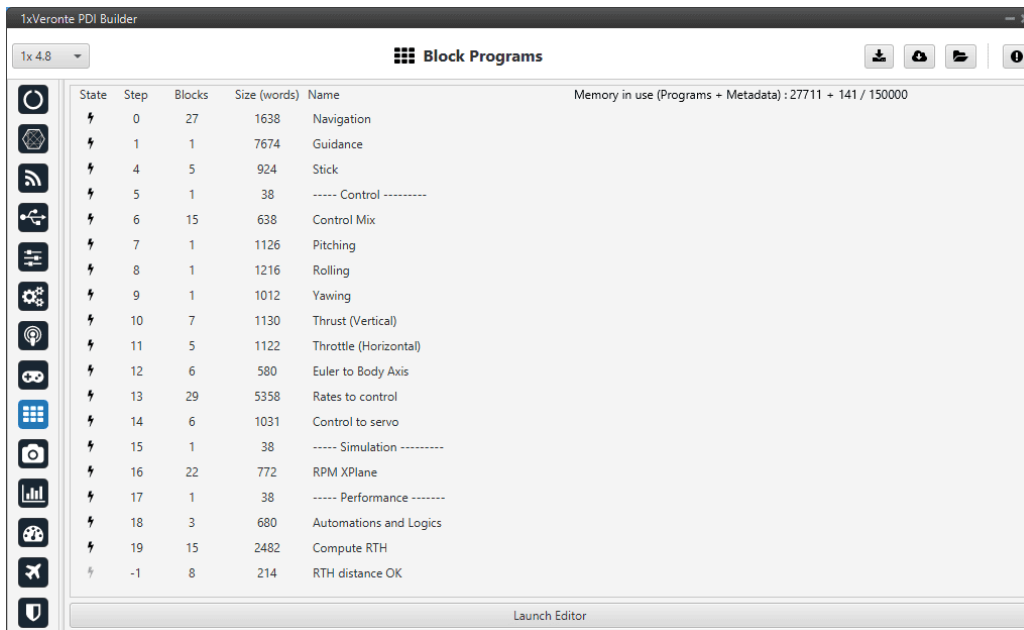

Block Programs menu

The following programs have been developed for the configuration of the Embention VTOI aircraft:

Note

The program name is defined by the user, so they do not have to match these.

- **Navigation**: Control laws that allow navigation through the use of both **internal and external sensors**.
- **Guidance**: Control laws that allow obtaining a precise **guidance** to perform the **desired mission**.
- **Stick**: Block program to transform pilot stick actions into **input values** to Autopilot 1x.
- **Control Mix**: Block program that establishes the optimal **flight configuration** as a function of the IAS value.
- **Pitching**: Control laws for performing perform **Pitch** in both multicopter and fixed-wing (FW) flight configurations.
- **Rolling**: Control laws for performing **Roll** in both multicopter and fixed-wing (FW) flight configurations.
- **Yawing**: Control laws for performing **Yaw** in both multicopter and fixed-wing (FW) flight configurations.

- **Thrust (Vertical)**: Control laws for performing **Thrust** in multicopter flight configurations.
- **Throttle (Horizontal)**: Control laws for performing **Thrust** in fixed-wing (FW) flight configurations.
- **Euler to Body Axis**: Program that transforms a reference system from **Euler Axis** to **Body Axis**.
- **Rates to control**: Control laws that transform the desired guidance variables into **output controls**.
- **Control to servo**: Control laws that transform output controls into **servo actions**.
- **RPM XPlane**: Program that allows to transform the aircraft real performance in a **simulated environment**.
- **Compute RTH**: Program to allow the aircraft to choose from several points which is the best one to be used as **RTH point** for the RTH phase.
- **RTH distance OK**: Program to check if a particular point is suitable to start the **RTH phase**.

For more information, visit the [Block Programs](#) section of the **1x PDI Builder** user manual.

Navigation

The following program is defined to configure all sensors that will be used to determine the navigation of the Autopilot 1x.

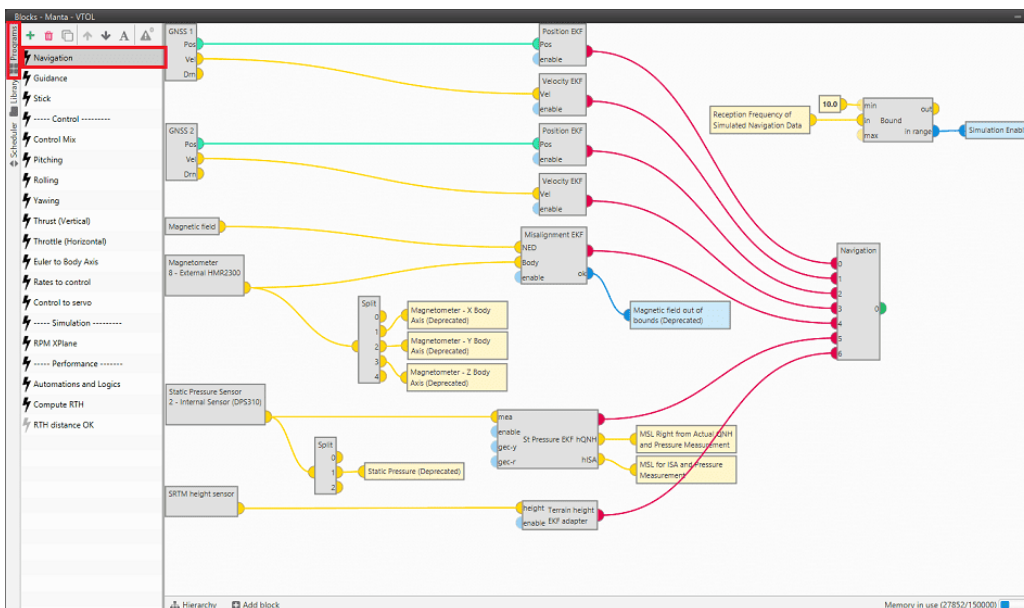

Navigation - Program

Follow the steps below for a basic configuration of the sensors that enable 1x navigation.

⚠ Important

Each sensor used in the autopilot navigation must be connected to its corresponding **EKF adapter** in order to be read correctly by the [Navigation block](#) algorithm.

GNSS Sensors

⚠ Important

The [GNSS sensor block](#) must be connected to two different EKF adapters for its two outputs, [Position EKF block](#) and [Velocity EKF block](#).

For more information on this block, visit the [GNSS sensor - Sensors blocks](#) section of the **1x PDI Builder** user manual.

- GNSS blocks

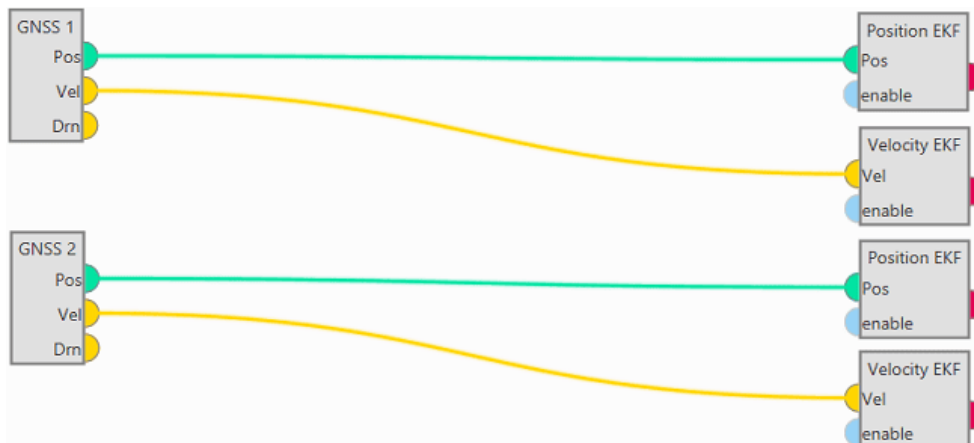



- GNSS
 - Meas Rate: 0.25 s
 - PPP: Disabled
- Survey In: Disabled
- SPI Port - Mask in
 - ublox: Enabled
 - nmea: Disabled

- rtcm: Disabled
- rtcm3: Enabled
- SPI Port - Mask out
 - ublox: Enabled
 - nmea: Disabled
 - rtcm3: Disabled
- Position/Velocity EKF Adapters

Note

The EKF adapters used for the [GNSS sensor block](#), [Position EKF block](#) and [Velocity EKF block](#), have the same configuration parameters, so only one of them is shown, the other being similar.

- Square error on strong acceleration for position = 20.0; $(m/s)^2$
- Acceleration = 30.0; m/s^2
- Duration of effect (disappears lineary with time) = 2.5; s
- Use position measures in the attitude calculation: *Disabled*

Position EKF adapter settings	
Square error on strong acceleration for position	20.0 (m/s) ²
Acceleration:	30.0 m/s ²
Duration of effect(disappears linearly with time):	2.5 s
<input type="checkbox"/> Use position measures in the attitude calculation	
Accept	

Magnetometer Sensor

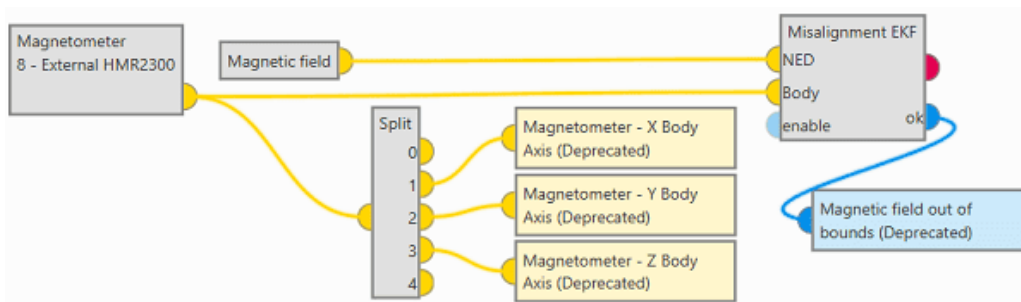

For more information, visit the [Magnetometer - Sensors blocks](#) section of the **1x PDI Builder** user manual.

The basic configuration of these blocks is shown below:

- Magnetic field block

This block has no configuration. For a detailed explanation about it, refer to the [Magnetic Field - Sensors blocks](#) section of the **1x PDI Builder** user manual,

- Magnetometer block

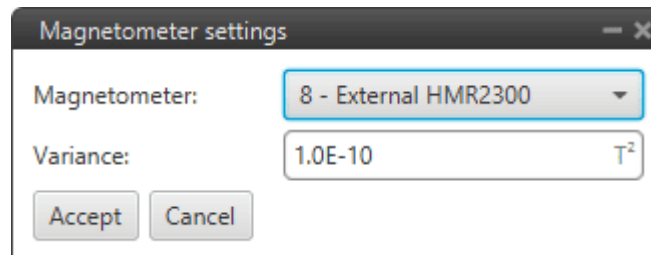

◦ Magnetometer: External HMR2300

- Variance: 1.0E-10 T²

- Misalignment EKF Adapter

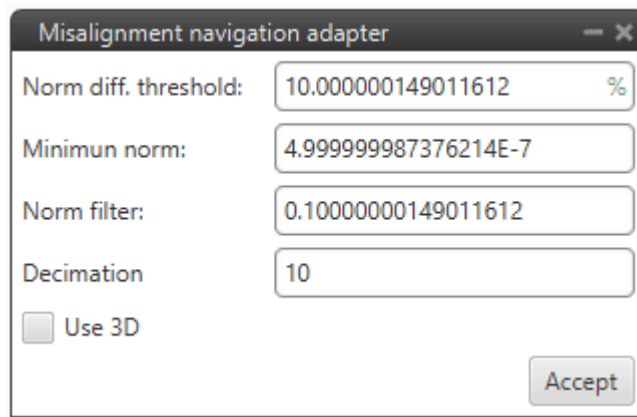

- Norm diff. threshold: 10 %
- Minimum norm: 5E-7
- Norm filter: 0.1
- Decimation: 10
- Use 3D: Disabled

Static Pressure Sensor

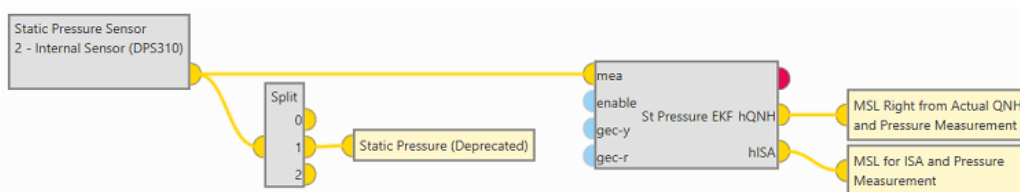

For more information, visit the [Static Pressure - Sensors blocks](#) section of the **1x PDI Builder** user manual.

The basic configuration of these blocks is shown below:

- Static Pressure block

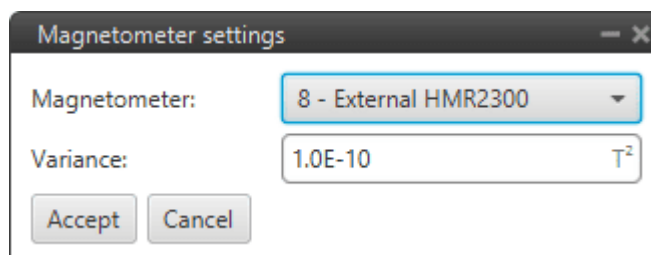

Static pressure sensor: Internal Sensor (DPS310)

- Variance: 1000.0 Pa²

- Static Pressure EKF Adapter

Navigation EKF Adapter for Static Pressure

Variance rate limit

Max falling rate -9900.0 Pa²/s

Max rising rate 0.0 Pa²/s

Square error compensation

Square error 10000.0 Pa²

Altitude correction threshold (Positive down) 0.0 m

Decimation 10

Edit correction compensation

Accept Cancel

- Max falling rate: Enabled, ⇒ -9900.0 Pa²/s
- Max rising rate: Disabled
- Square error: 10000.0 Pa²
- Altitude correction threshold: 0.0 m
- Decimation: 10
- Edit correction compensation:
Points entered:
-5.0 ; -1.5

-4.0 ; -0.5

-0.5 ; -0.5

1.0 ; 1.0

SRTM height Sensor



For more information, visit the [SRTM height - Sensors block](#) section of the **1x PDI Builder** user manual.

The basic configuration of these blocks is shown below:

- SRTM height block

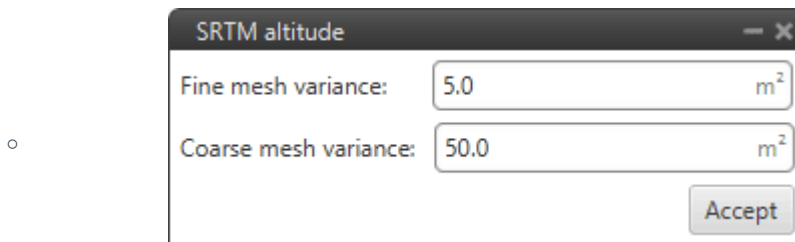

Fine mesh variance: 5.0 m²

- Coarse mesh variance: 50.0 m²

- Terrain height EKF Adapter

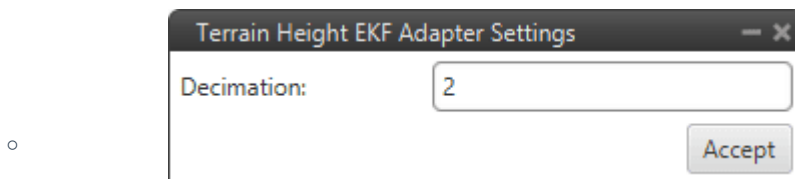

Decimation: 2

Navigation Block

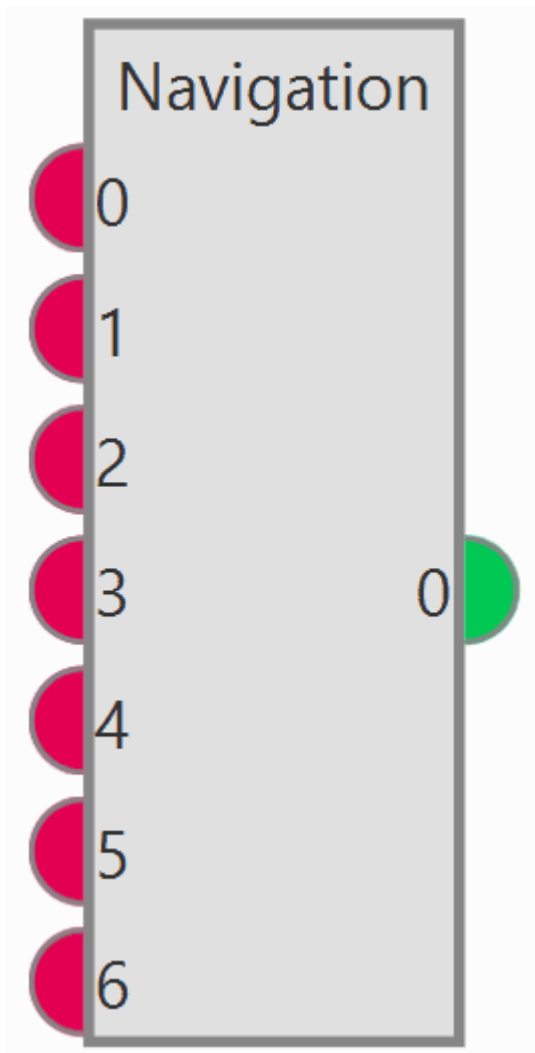

For more information, visit the [Navigation - Navigation blocks](#) section of the **1x PDI Builder** user manual.

The basic configuration of this block is shown below:

- Inputs size: **7**

Important

Navigation block is configured to have as many inputs as EKF adapters are used in the sensors. These adapters are the ones that transmit the measurements to the **Navigation block**.

- GPS ok time to restore restricted mask: **5.0**
- Filter parameters
 - Beta: 0.01 rad/s ; Initial: 10.0 rad/s
 - Zeta: 3.0E – 4 rad/s^2 ; Initial: 0.0 rad/s^2
- Navigation: *Internal*
- Accelerometer
 - Qnfb: 3.0 ; 3.0 ; 3.0
 - Qdfb: 0.005 ; 0.005 ; 3.0E – 4
- Gyroscope
 - Qnwb: 0.01 ; 0.01 ; 0.01
 - Qdwb: 4.0E – 6 ; 4.0E – 6 ; 4.0E – 6

- Qdem
 - Value: *Vegetated*

Guidance

The guidance program defines the **control laws** in each of the flight phases.

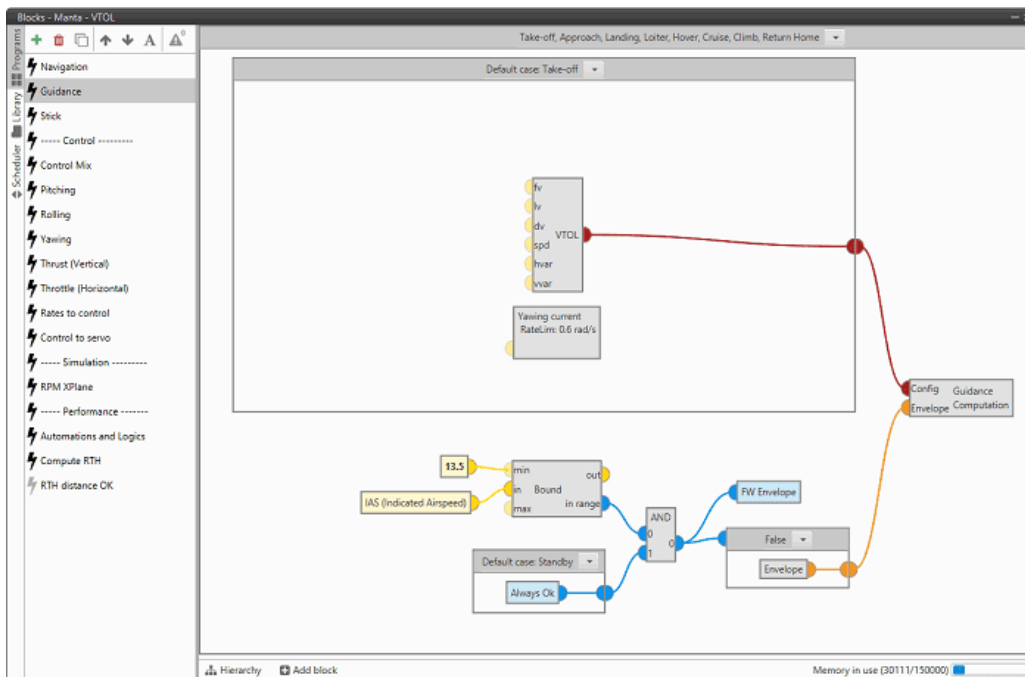

Guidance - Program

- **Standby, Armed, Flight Control Check, Init**

In these flight phases, guidance control is not necessary since the aircraft is not flying.

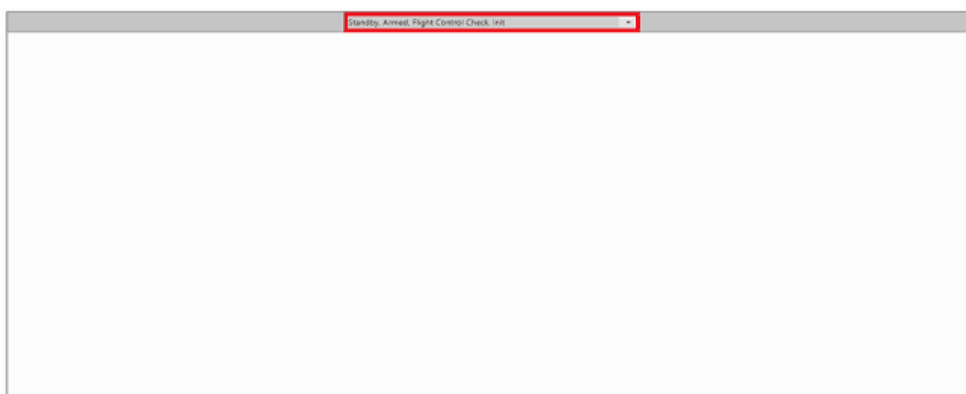

Guidance - Standby, Armed, Flight Control Check and Init phases

- **Hold**

The Hold flight phase stabilizes the attitude and vertical speed of the aircraft.

Important

The values in Auto mode of the control variables are null, being the Stick commands the ones that modify these variables.

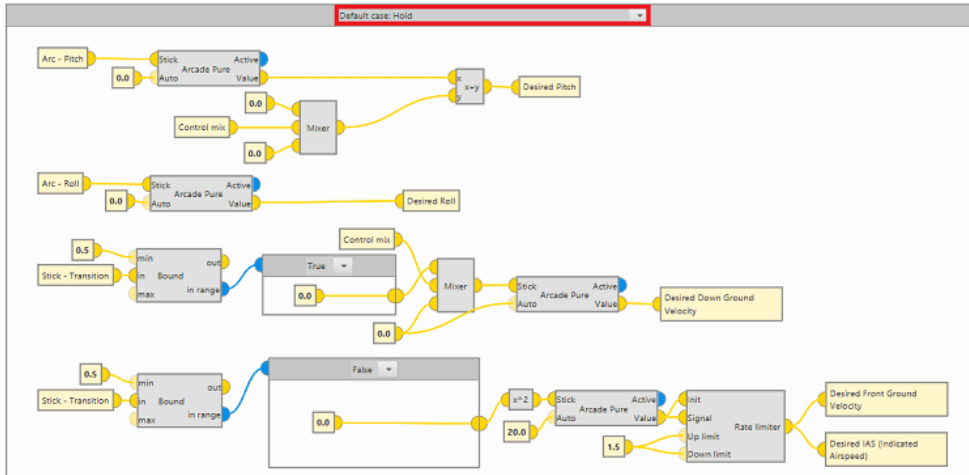

Guidance - Hold phase

- The **Desired Pitch** value is obtained from the [Arcade Pure block](#). The Stick input reads the value of the Arc-Pitch variable, which will directly define the **Desired Pitch** when the aircraft is in Arcade mode.

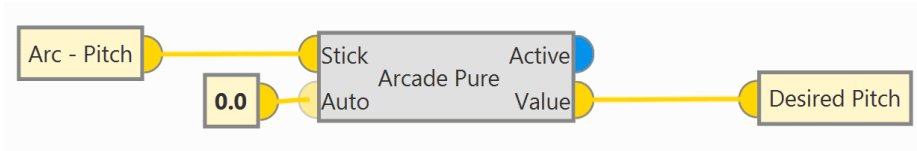

- The **Desired Roll** value is obtained from the [Arcade Pure block](#). The Stick input reads the value of the Arc-Roll variable, which will directly define the **Desired Roll** when the aircraft is in Arcade mode.

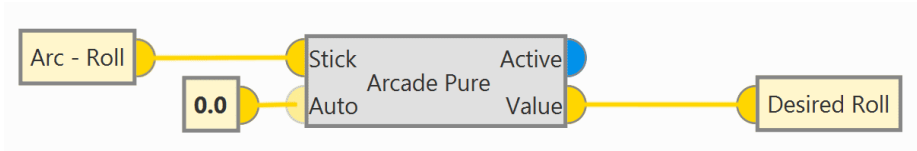

- If the value of the **Stick-Transition** variable is **less than 0.5** (aircraft flying in **quadcopter configuration**):
 - The **Desired Down Ground Velocity** value is obtained from the [Arcade Pure block](#), where the Stick input directly reads the value of the Arc-Throttle variable.

- The **Desired Front Ground Velocity** and **Desired IAS** values are obtained from the **Arcade Pure** block in Auto mode with a value of **20.0**.

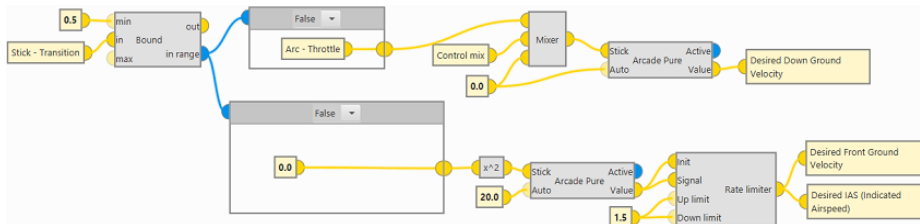

- If the value of the **Stick-Transition** variable is **greater than 0.5** the aircraft transitions to **FW configuration** and the control variable becomes **Desired Front Ground Velocity**:
 - The **Desired Down Ground Velocity** value is null.
 - The **Desired Front Ground Velocity** and **Desired IAS** values are obtained from the **Arcade Pure** block, in which the Stick input has a value dependent on the Stick-Throttle variable.

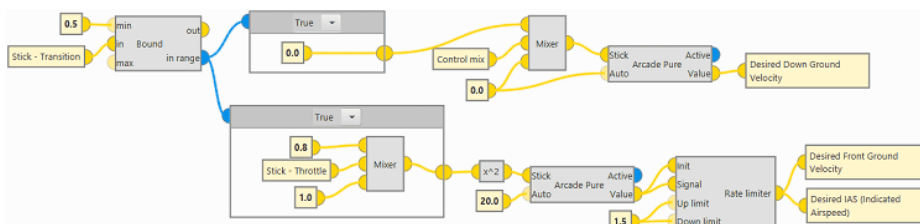

- **Take-off, Approach, Landing, Loiter, Hover, Cruise, Climb, Return Home**

In the following phases the guidance control is mainly configured with the **Guidance Computation** block, which is set with two inputs: **Config** and **Envelope**. The latter being common for this group of phases.

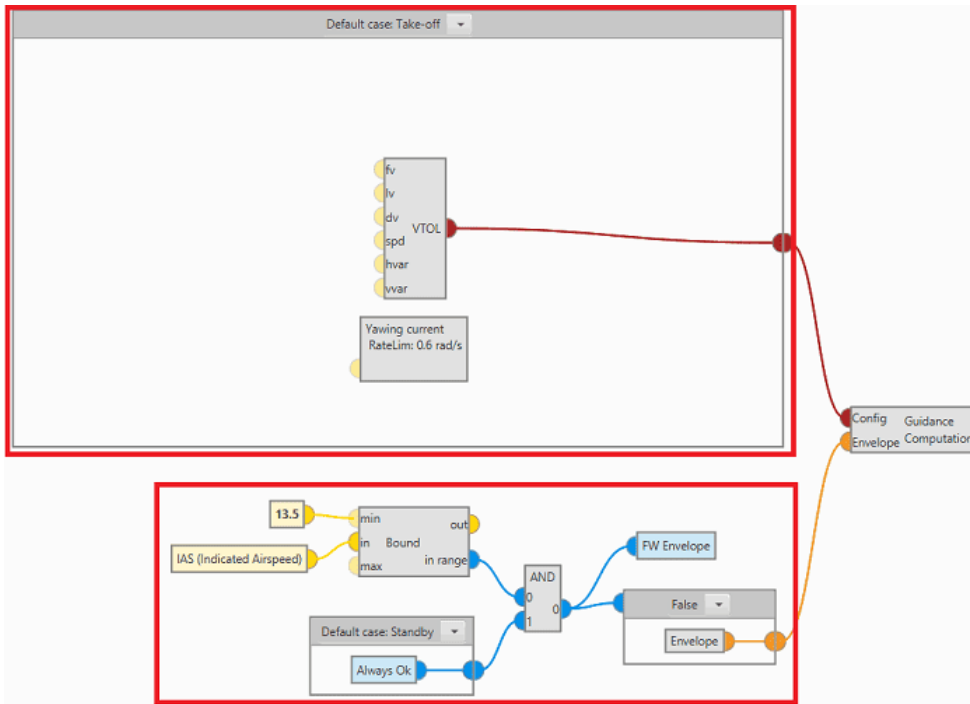

Guidance - Take-off, Approach, Landing, Loiter, Hover, Cruise, Climb and Return Home phases

◦ **Envelope input**

The Envelope input must always be connected to the [Envelope block](#). This block defines the limits that must not be exceeded during operation, so these limits will depend on the flight configuration (Multi or FW).

To establish which flight configuration the aircraft is in, the following logic is defined:

1. The [Bound block](#) returns the bit in range **true** if IAS is greater than **13.5 m/s**.

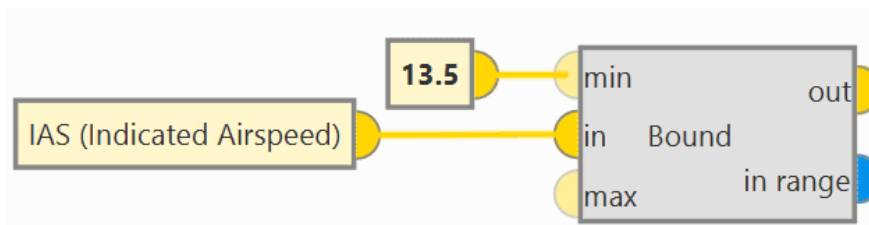

2. Always Ok bit in flight phase Standby or Always Fail bit in flight phase Hover.

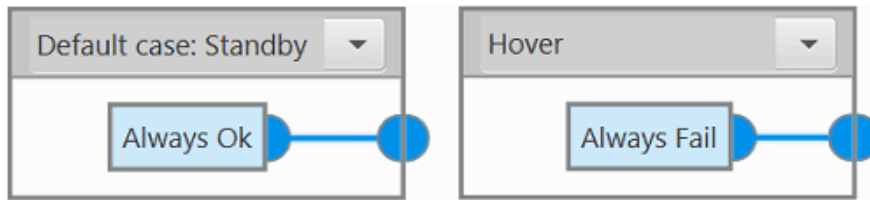

- 3. If both **bits** (1 and 2) are **true**, the FW Envelope bit is **true** and the **Envelope block** is defined for the **FW configuration**.

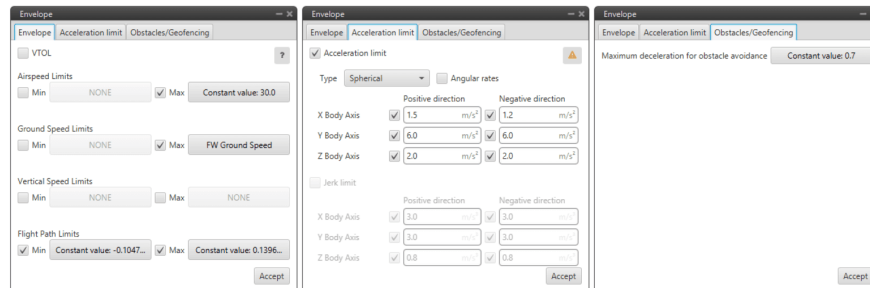
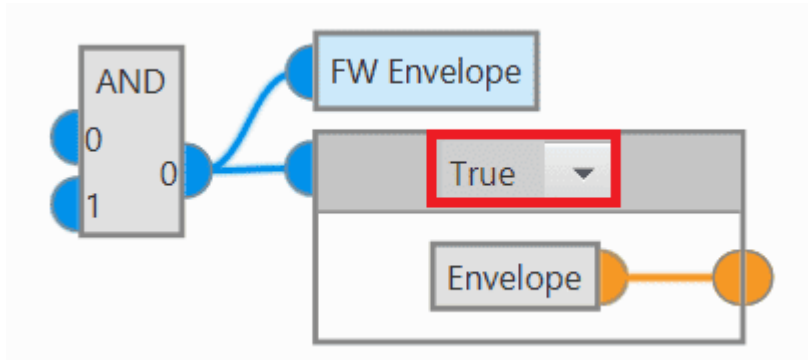

Envelope block - FW configuration

- 4. If it is **not** satisfied that both **bits** (1 and 2) are **true**, the FW Envelope bit is **false** and the **Envelope block** is set for the **quadcopter configuration**.

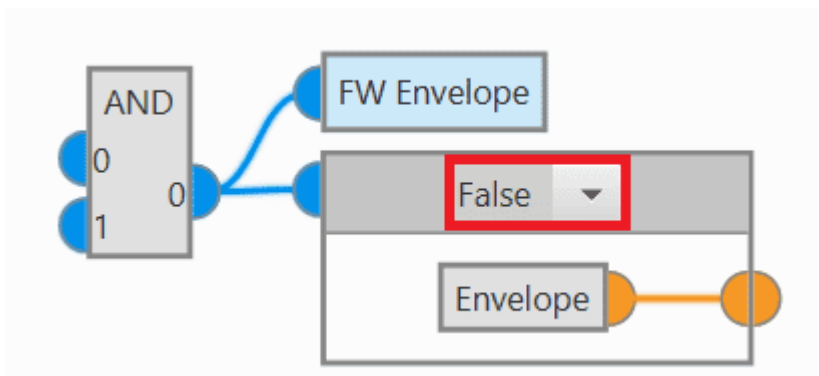

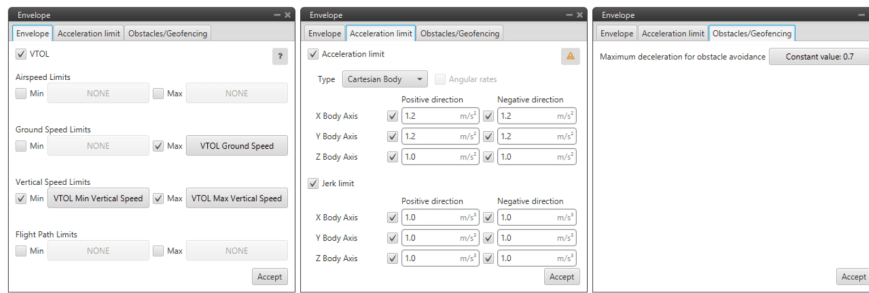

Envelope block - Quadcopter configuration

- **Config input**

The Config input must always be connected to a [Guidance block](#), which will vary depending on the flight phase.

- **Take-off**

The guidance configuration in this phase consists of the [VTOL block](#), which is linked to the Config input, and the [Yawing current block](#).

- **VTOL** guidance is used in multicopters for the **take-off** and landing operations.

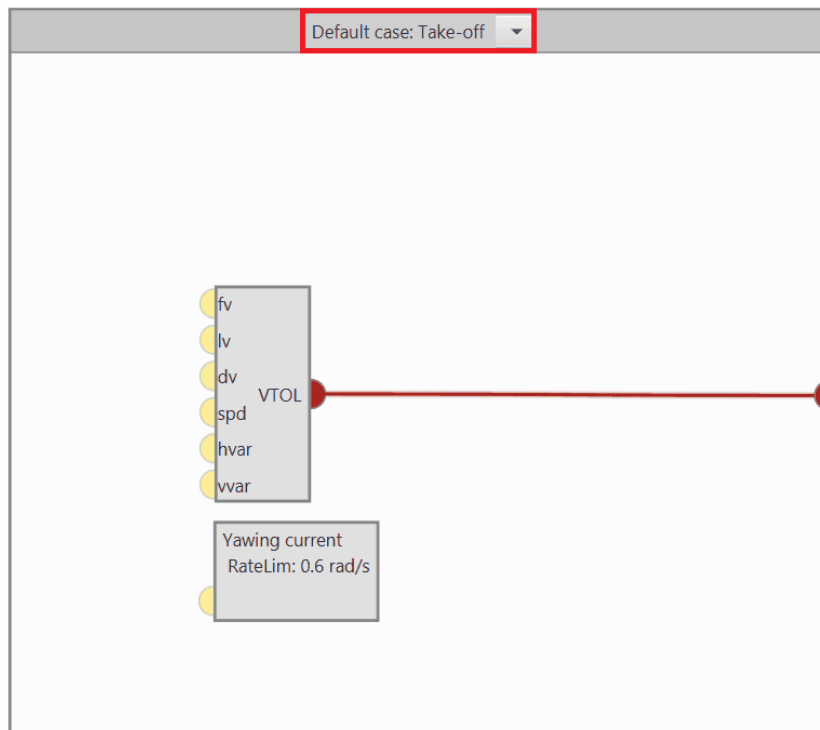

A basic configuration of this block is shown below:

The screenshot shows the VTOL configuration window with the following settings:

- Patch:** Disabled (checkbox)
- Set height mode:** 3D (dropdown)
- Arcade position/speed transition:**
 - Horizontal: 1.0 m/s
 - Vertical: 1.0 m/s
- Set speed:**
 - Cruise: 1.5 m/s (gear icon)
 - Waypoint: Disabled (checkbox), 1.5 m/s (gear icon)
 - Type: Ground Speed (dropdown)
 - Deceleration: 1.0 m/s²
- Guidance control:** (help icon ?)
 - Horizontal Type: PID (dropdown, edit icon)
 - Vertical Type: PID (dropdown, edit icon)
 - Type: Straight (dropdown)
 - Extend: None (dropdown)
 - Safe: -100 m (gear icon), Relative (dropdown)
 - Touch: Runway Touch Point (dropdown, link icon)

Accept button is located at the bottom right.

- Patch: Disabled
- Set height mode: 3D
- Arcade position/speed transition
 - Horizontal: 1.0 m/s
 - Vertical: 1.0 m/s
- Set speed
 - Cruise: 1.5 m/s
 - Waypoint: Disabled
 - Type: Ground Speed

Deceleration: 1.0 m/s²

- Guidance control

Horizontal: PID

Vertical: PID

Type: Straight

Extend: None

Safe: -1000.0 m ⇒ Relative

- With the Yawing current block it is intended that the aircraft **maintains the yaw angle it has when entering the phase**, i.e. Desired Yaw = Current Yaw.

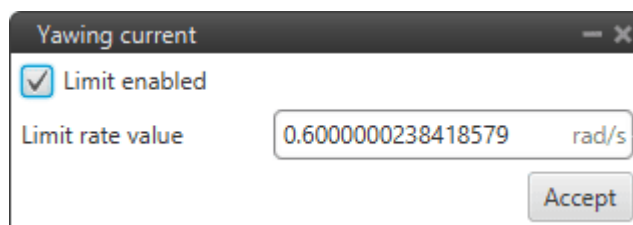
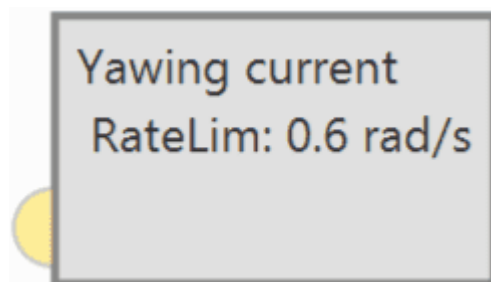

In addition, a **limit rate value** of 0.6 *rad/s* has been defined to control the speed at which the aircraft yaws in the guidance of this phase.

- **Landing**

The guidance configuration in this phase consists of the [VTOL block](#), which is linked to the Config input, and the [Yawing current block](#).

- **VTOL** guidance is used in multicopters for the take-off and **landing** operations.

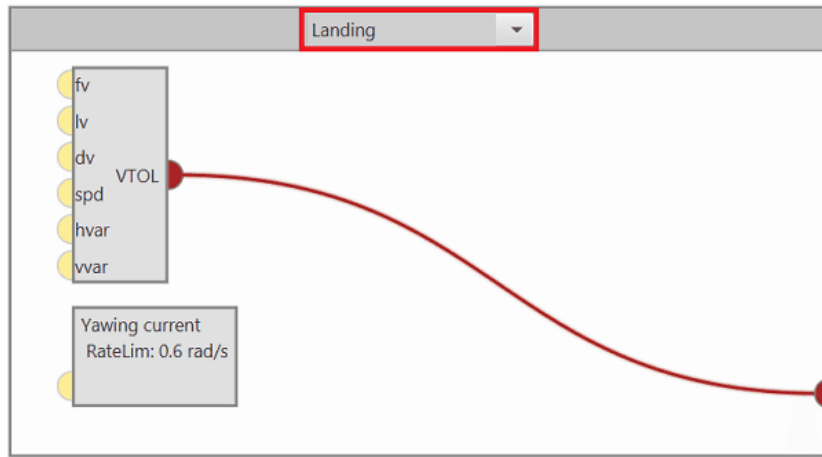

A basic configuration of this block is shown below:

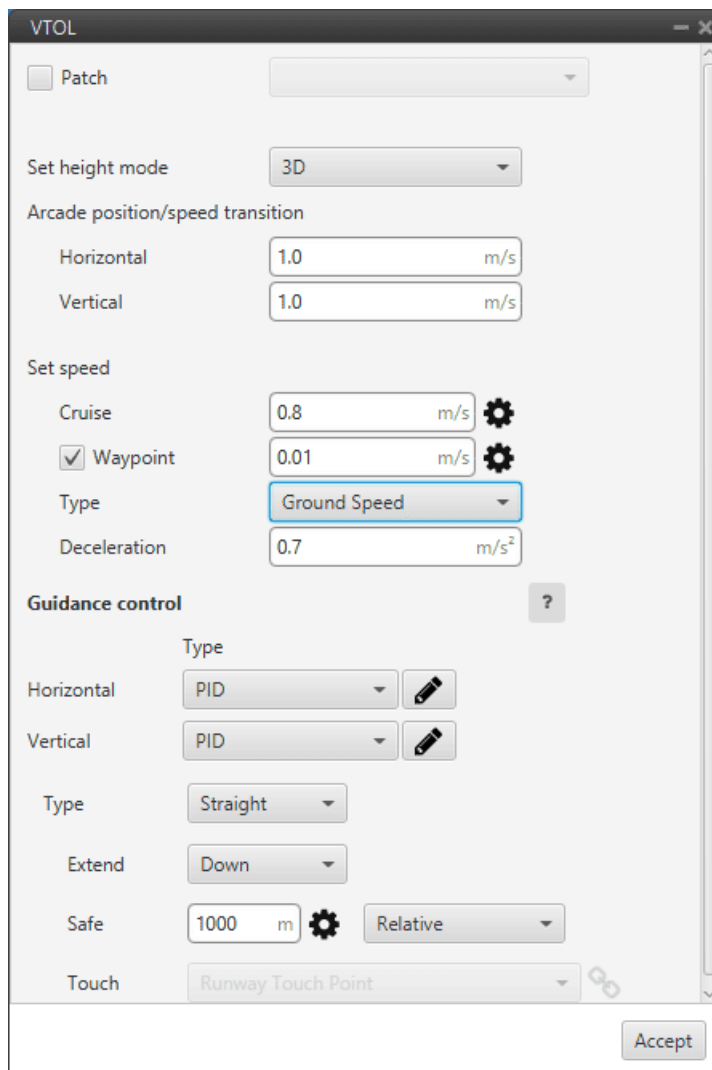

- Patch: Disabled

- Set height mode: 3D
 - Arcade position/speed transition
Horizontal: 1.0 m/s
Vertical: 1.0 m/s
 - Set speed
Cruise: 0.8 m/s
Waypoint: 0.01 m/s
Type: Ground Speed
Deceleration: 0.7 m/s²
 - Guidance control
Horizontal: PID
Vertical: PID
Type: Straight
Extend: Down
Safe: -1000.0 m ⇒ Relative
-
- With the Yawing current block it is intended that the aircraft **maintains the yaw angle it has when entering the phase**, i.e. Desired Yaw = Current Yaw.

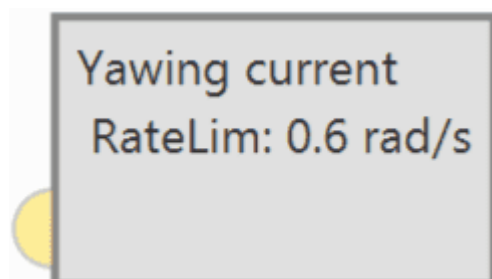

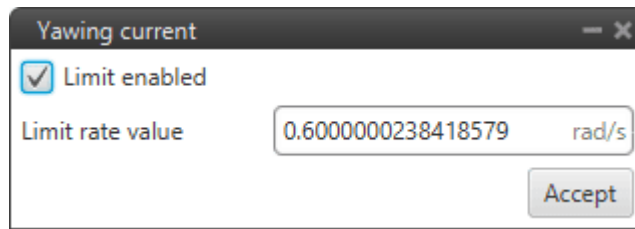

In addition, a **limit rate value** of 0.6 *rad/s* has been defined to control the speed at which the aircraft yaws in the guidance of this phase.

- **Hover**

The guidance configuration in this phase consists of the [Cruise block](#), which is linked to the Config input, and the [Yawing current block](#).

- **Cruise** guidance is used to make the aircraft follow a position-based route created by the user.

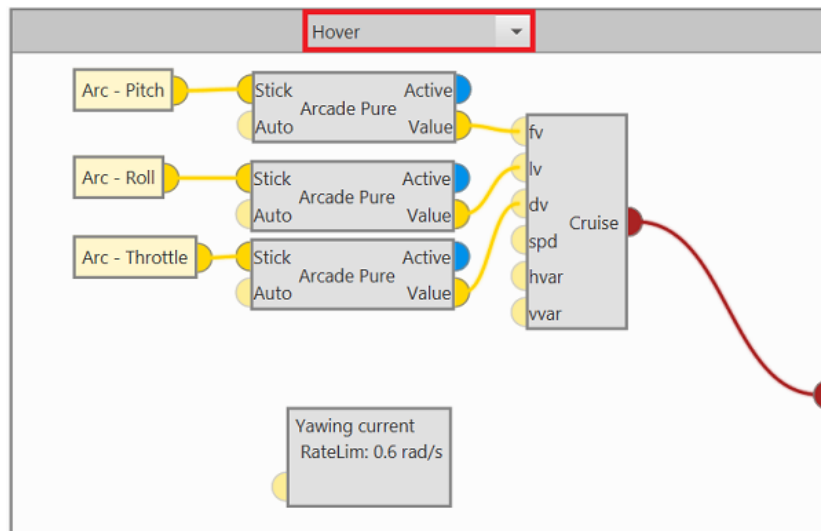

A basic configuration of this block is shown below:

Cruise

Patch

Set height mode: 3D

Arcade position/speed transition

Horizontal: 1.0 m/s

Vertical: 1.0 m/s

Set speed

Cruise: 3.0 m/s

Waypoint: 0.5 m/s

Type: Ground Speed

Deceleration: 1.0 m/s²

Guidance control

Horizontal: PID

Vertical: PID

Accept

- Patch: Disabled
- Set height mode: 3D
- Arcade position/speed transition
Horizontal: 1.0 m/s
Vertical: 1.0 m/s
- Set speed
Cruise: 3 m/s
Waypoint: 0.5 m/s
Type: Ground Speed
Deceleration: 1.0 m/s²
- Guidance control
Horizontal: PID
Vertical: PID

Moreover, the output of each of the **Arcade Pure** blocks are used as inputs for this guidance block. These output values match the value of the Stick input when the aircraft is controlled in **Arcade mode**.

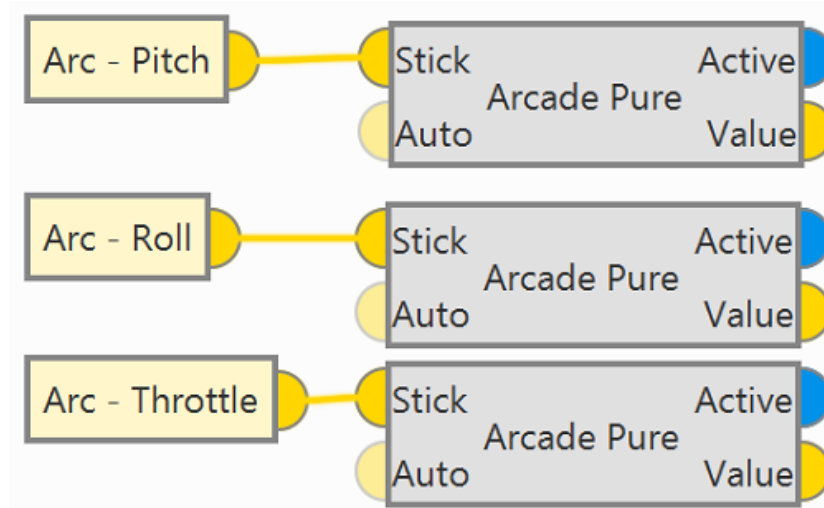

- Arcade Pure (Arc-Pitch) ⇒ **fv**: The **Pitch** value commanded by the **stick** will be the **first** component of the desired 'hover here' arcade velocity in the horizontal plane.
- Arcade Pure (Arc-Roll) ⇒ **lv**: The **Roll** value commanded by the **stick** will be the **second** component of the desired 'hover here' arcade velocity in the horizontal plane.
- Arcade Pure (Arc-Throttle) ⇒ **dv**: The **Throttle** value commanded by the **stick** will be the **down** (vertical) component of the desired 'hover here' arcade velocity.

For more information, visit the [Guidance blocks common configuration - Guidance blocks](#) section of the **1x PDI Builder** user manual.

- With the Yawing current block it is intended that the aircraft **maintains the yaw angle it has when entering the phase**, i.e. Desired Yaw = Current Yaw.

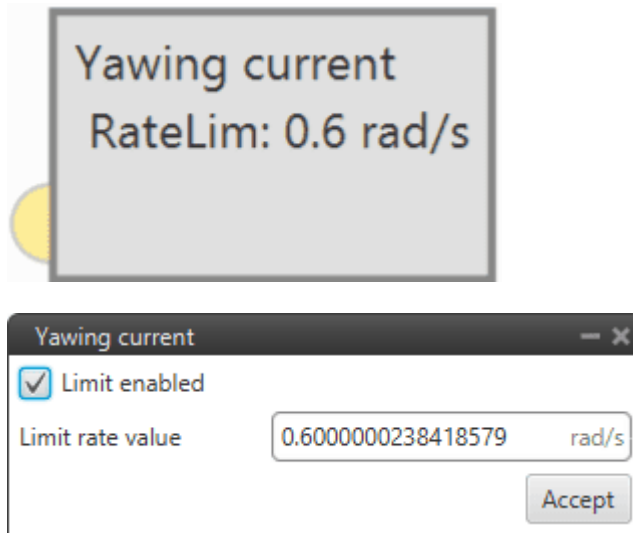

In addition, a **limit rate value** of 0.6 rad/s has been defined to control the speed at which the aircraft yaws in the guidance of this phase.

- **Loiter and Cruise**

The guidance configuration for these phases is composed of the [Cruise block](#), which is linked to the Config input, and the [Yawing north block](#).

- **Cruise** guidance is used to make the aircraft follow a position-based route created by the user.

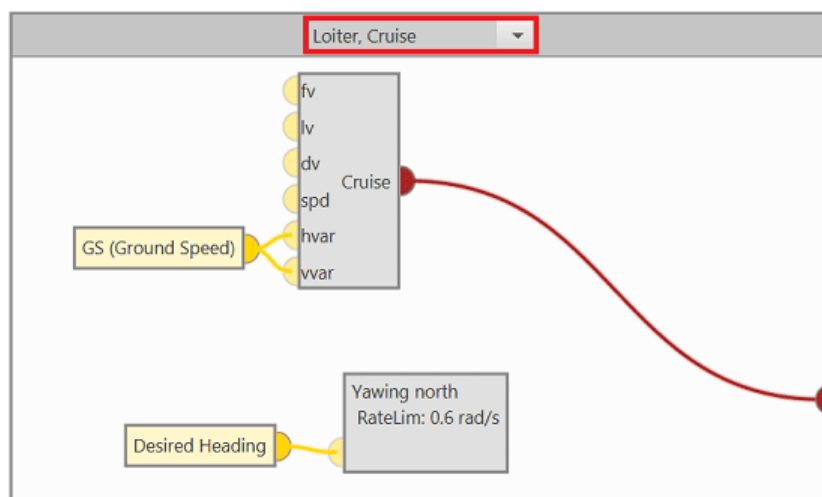

A basic configuration of this block is shown below:

Cruise

Patch

Set height mode: 3D

Arcade position/speed transition

Horizontal: 1.0 m/s

Vertical: 1.0 m/s

Set speed

Cruise: 26.0 m/s

Waypoint: 26.0 m/s

Type: Ground Speed

Deceleration: 2.0 m/s²

Guidance control ?

Horizontal Type: Table

Vertical Type: PID

Accept

- Patch: Disabled
- Set height mode: 3D
- Arcade position/speed transition
 - Horizontal: 1.0 m/s
 - Vertical: 1.0 m/s
- Set speed
 - Cruise: 26 m/s
 - Waypoint: Disabled
 - Type: Ground Speed
 - Deceleration: 2.0 m/s²
- Guidance control
 - Horizontal: PID
 - Vertical: PID

In addition, the GS (Ground Speed) variable is linked to 2 inputs of this guidance block:

- GS (Ground Speed) \Rightarrow **hvar: Horizontal** scale variable used for the [T-Sched PID](#).
- GS (Ground Speed) \Rightarrow **vvar: Vertical** scale variable used for the [T-Sched PID](#).

For more information, visit the [Guidance blocks common configuration - Guidance blocks](#) section of the **1x PDI Builder** user manual.

- With the Yawing north block it is desired that the aircraft maintains the yaw to the north (angle 0°). However, if there is any variable connected to the input of the block, this is taken as an offset with respect to the reference, that being 0° , the aircraft will point directly to the angle indicated as offset.

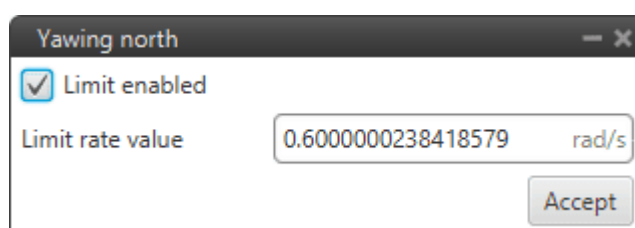
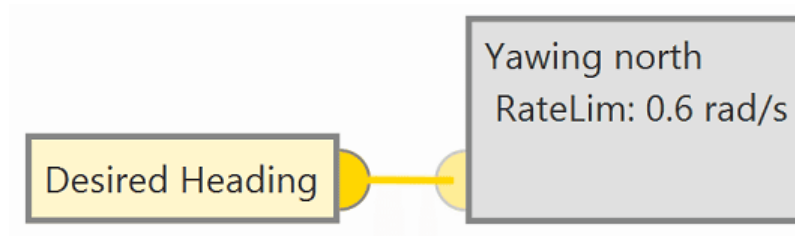

In this case, the variable Desired Heading is connected to the input, so Desired Yaw = Desired Heading.

In addition, a **limit rate value** of 0.6 rad/s has been defined for controlling the speed at which the aircraft yaws in the guidance of this phase.

- Approach**

The guidance configuration in this phase consists of the [Landing block](#), which is linked to the Config input, and the [Yawing north block](#).

- Landing** guidance is used to generate the flying path the aircraft will follow when landing on a certain runway.

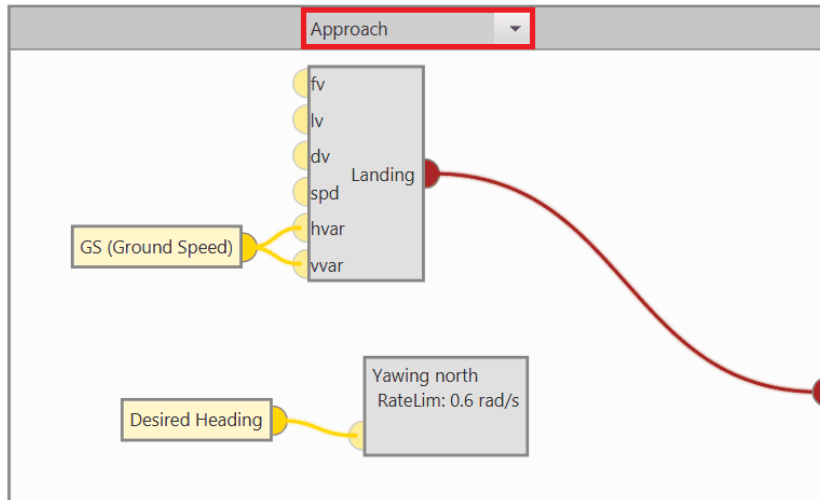

A basic configuration of this block is shown below:

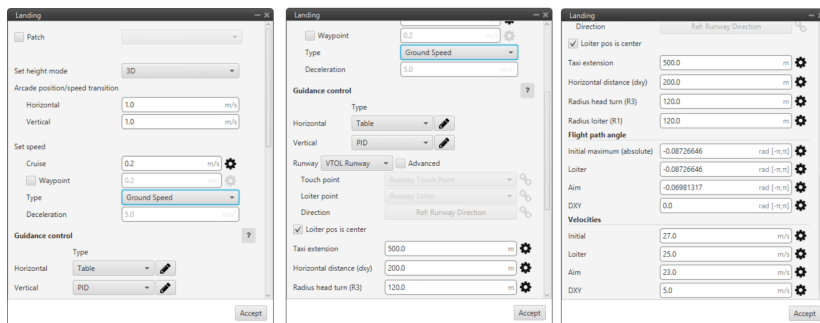

In addition, the GS (Ground Speed) variable is linked to 2 inputs of this guidance block:

- GS (Ground Speed) ⇒ **hvar: Horizontal** scale variable used for the [T-Sched PID](#).
- GS (Ground Speed) ⇒ **vvar: Vertical** scale variable used for the [T-Sched PID](#).

For more information, visit the [Guidance blocks common configuration - Guidance blocks](#) section of the **1x PDI Builder** user manual.

- With the Yawing north block it is desired that the aircraft maintains the yaw to the north (angle 0°). However, if there is any variable connected to the input of the block, this is taken as an offset with respect to the reference, that being 0° , the aircraft will point directly to the angle indicated as offset.

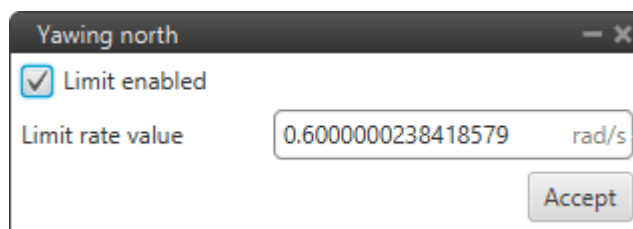
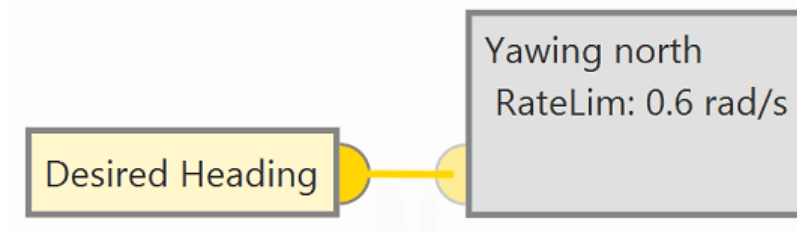

In this case, the variable Desired Heading is connected to the input, so Desired Yaw = Desired Heading.

In addition, a **limit rate value** of 0.6 rad/s has been defined for controlling the speed at which the aircraft yaws in the guidance of this phase.

- **Return Home**

On the one hand, the configuration of the guidance in this phase which will be linked to the Config input, depends on the definition of the **Home** point.

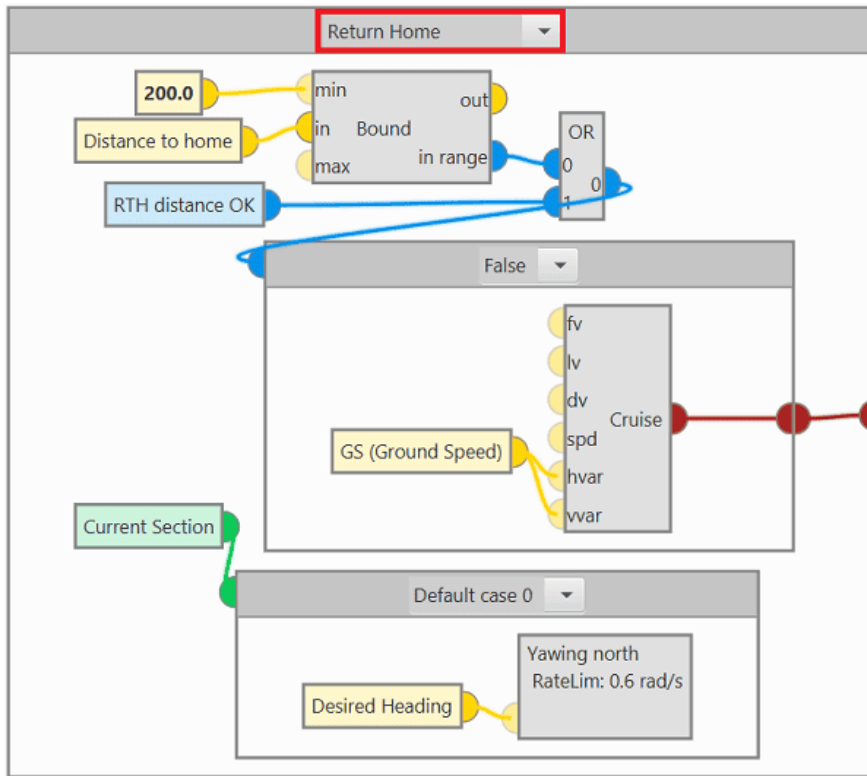

- If the Home point is **defined**, the **Rendezvous** block defines the guidance configuration for this phase.

Explanation

For the Home point to be defined, one of the two input bits of the **OR** block must be **true**.

Rendezvous guidance is used to follow a route to the runway. A basic configuration of this block is shown below:

The screenshot shows the 'Rendezvous' configuration window with the following settings:

- Patch
- Set height mode: 3D
- Arcade position/speed transition:
 - Horizontal: 1.0 m/s
 - Vertical: 1.0 m/s
- Set speed:
 - Cruise: 26.0 m/s
 - Waypoint: 1.5 m/s
 - Type: Ground Speed
 - Deceleration: 2.0 m/s²
- Guidance control:
 - Horizontal Type: Table
 - Vertical Type: Table
 - Rendezvous relative position: X: 0.0 m, Y: 0.0 m, Z: -50.0 m
 - Docking relative position: X: 0.0 m, Y: 0.0 m, Z: -10.0 m
 - Base yaw: Constant value: 0.0
 - Base pitch: Constant value: 0.0
 - Base roll: Constant value: 0.0
 - Docking base: Selected RTH

An 'Accept' button is located at the bottom right of the window.

In addition, the GS (Ground Speed) variable is linked to 2 inputs of this guidance block:

- GS (Ground Speed) ⇒ **hvar: Horizontal** scale variable used for the [T-Sched PID](#).
- GS (Ground Speed) ⇒ **vvar: Vertical** scale variable used for the [T-Sched PID](#).

For more information, visit the [Guidance blocks common configuration - Guidance blocks](#) section of the **1x PDI Builder** user manual.

- If the Home point is **not defined**, the [Cruise block](#) defines the guidance configuration for this phase.

Cruise guidance is used to follow a route until the Home point is defined. A basic configuration of this block is shown below:

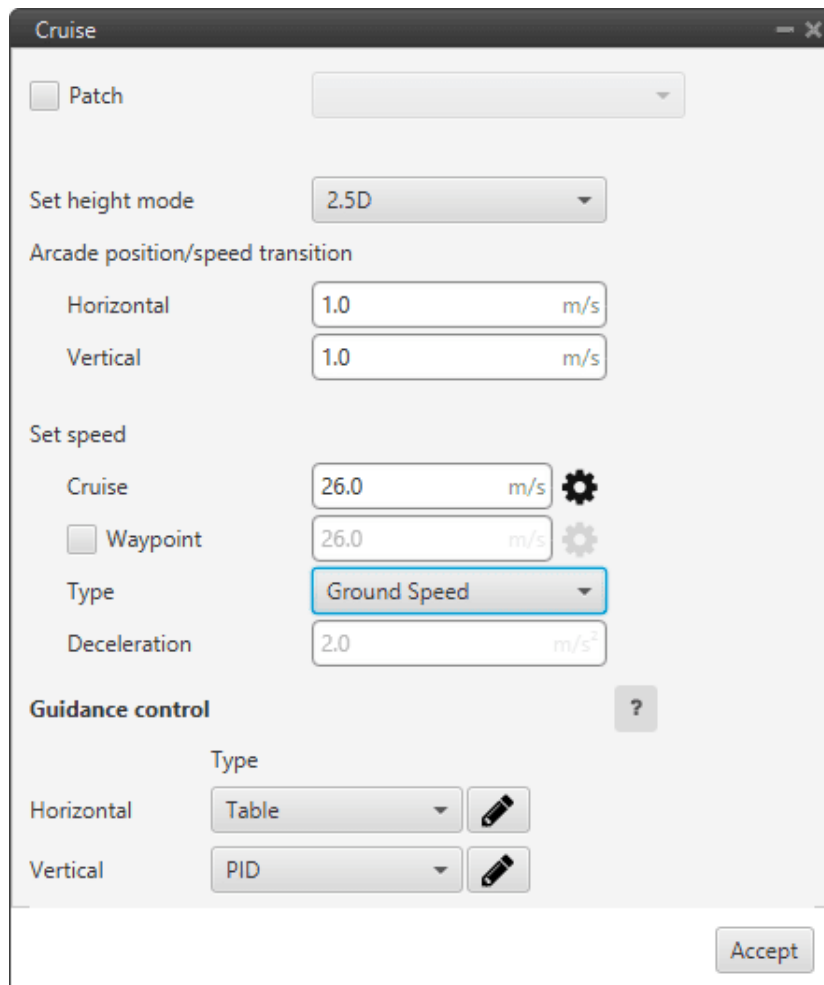

In addition, the GS (Ground Speed) variable is linked to 2 inputs of this guidance block:

- GS (Ground Speed) ⇒ **hvar: Horizontal** scale variable used for the [T-Sched PID](#).
- GS (Ground Speed) ⇒ **vvar: Vertical** scale variable used for the [T-Sched PID](#).

For more information, visit the [Guidance blocks common configuration - Guidance blocks](#) section of the **1x PDI Builder** user manual.

On the other hand, the value of the **Current Section** variable defines the aircraft reference for **Yaw**, i.e. it defines which yawing guidance block will be employed.

Note

Rendezvous guidance is divided into 3 sections (0, 1 and 2) where the aircraft behavior changes.

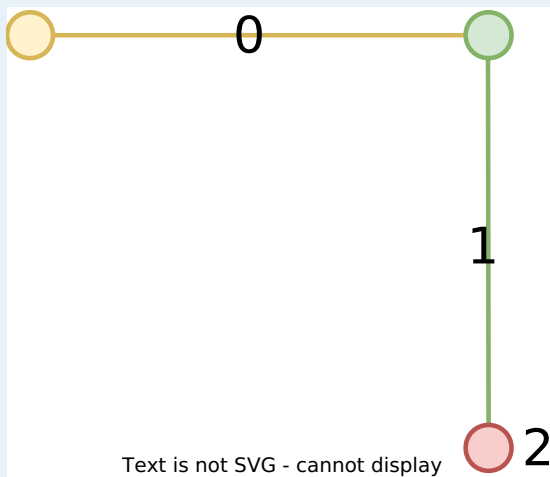

Sections of the rendezvous guidance

- In **case 0**, the [Yawing north](#) block is used.

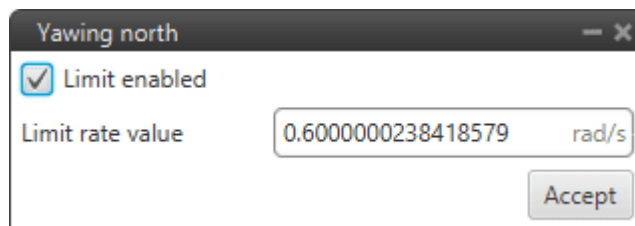
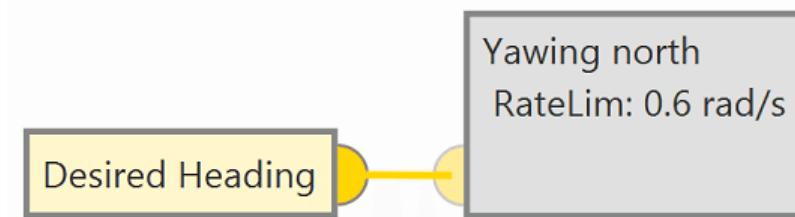

With this block it is desired that the aircraft maintains the yaw to the north (angle 0°).

However, if there is any variable connected to the input of the block, this is taken as an offset with respect to the reference, that being 0° , the aircraft will point directly to the angle indicated as offset.

In this case, the variable Desired Heading is connected to the input, so Desired Yaw = Desired Heading.

In addition, a **limit rate value** of 0.6 rad/s has been defined for controlling the speed at which the aircraft yaws in the guidance of this phase.

- In **cases 1 and 2**, the [Yawing current block](#) is used:

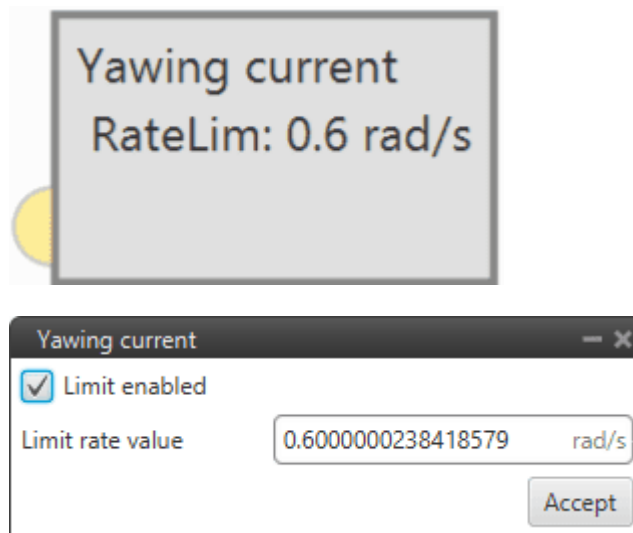

With the Yawing current block it is intended that the aircraft **maintains the yaw angle it has when entering the phase**, i.e. Desired Yaw = Current Yaw.

In addition, a **limit rate value** of 0.6 rad/s has been defined to control the speed at which the aircraft yaws in the guidance of this phase.

- **Climb**

The guidance configuration in this phase consists of the **Climb block**, which is linked to the Config input, and the **Yawing north block**.

- **Climb** guidance is used to make the aircraft climb from the start of the phase to another altitude.

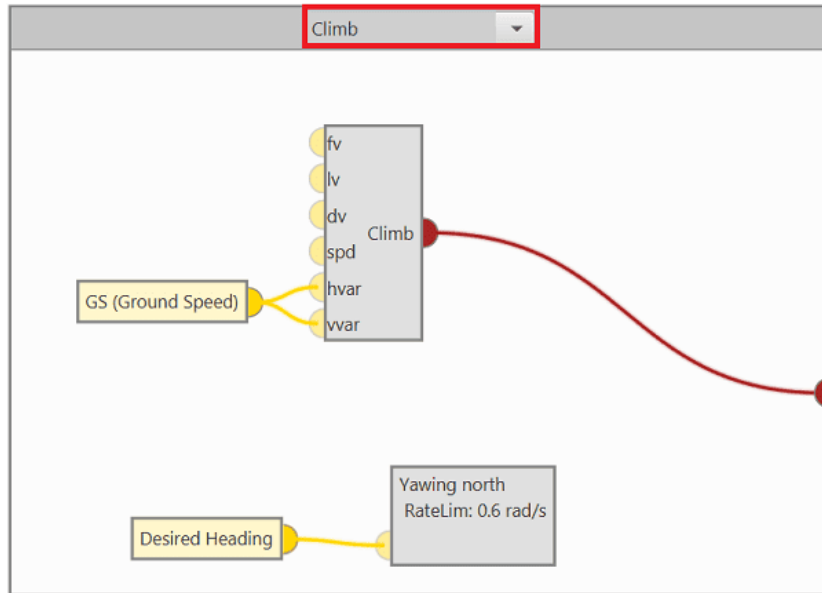

A basic configuration of this block is shown below:

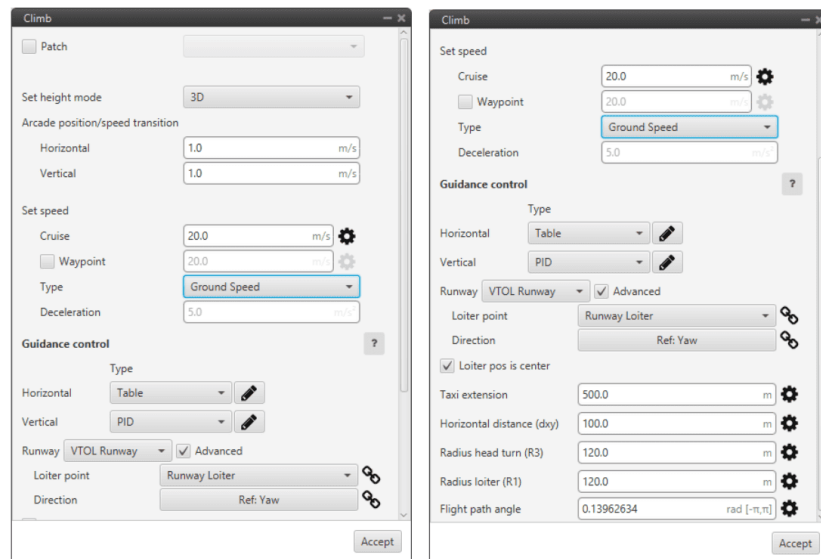

In addition, the GS (Ground Speed) variable is linked to 2 inputs of this guidance block:

- GS (Ground Speed) ⇒ **hvar: Horizontal** scale variable used for the **T-Sched PID**.

- GS (Ground Speed) ⇒ **vvar: Vertical** scale variable used for the **T-Sched PID**.

For more information, visit the [Guidance blocks common configuration - Guidance blocks](#) section of the **1x PDI Builder** user manual.

- With the Yawing north block it is desired that the aircraft maintains the yaw to the north (angle 0°). However, if there is any variable connected to the input of the block, this is taken as an offset with respect to the reference, that being 0° , the aircraft will point directly to the angle indicated as offset.

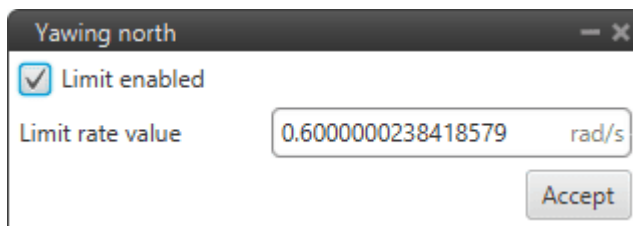
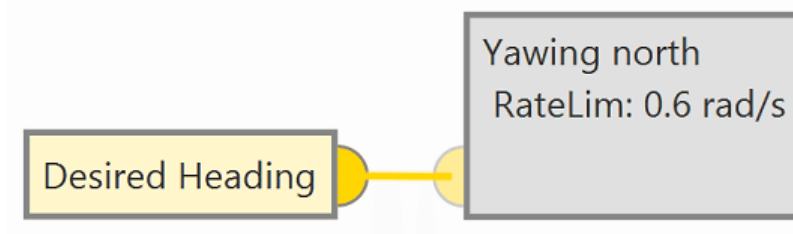

In this case, the variable Desired Heading is connected to the input, so Desired Yaw = Desired Heading.

In addition, a **limit rate value** of 0.6 rad/s has been defined for controlling the speed at which the aircraft yaws in the guidance of this phase.

Stick

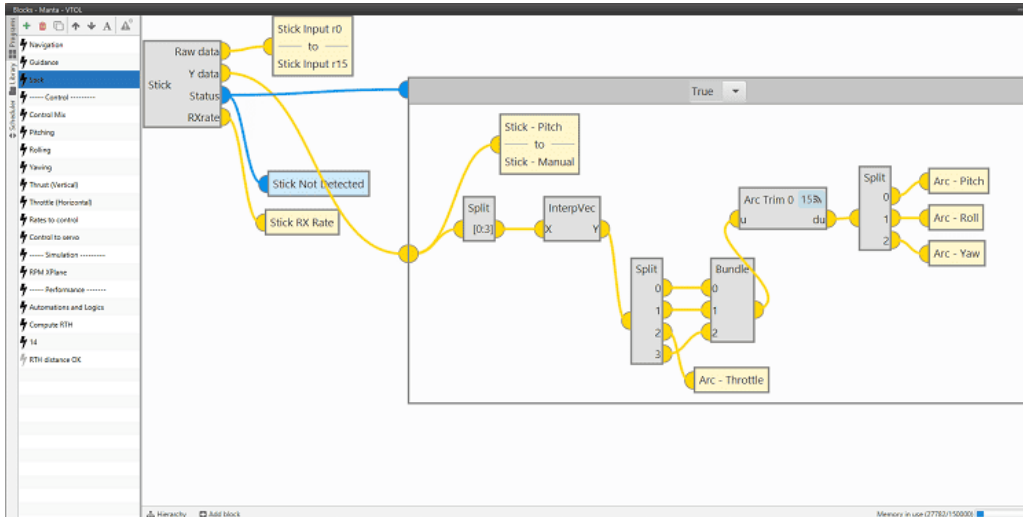

Stick - Program

Users can observe 2 parts in this program:

- **Stick block**

Stick block is a stick reader, with it the user can configure the stick parameters for manual and arcade modes.

- The configuration of this block while performing **simulation** is detailed in the [Stick - Simulation](#) section of this manual.
- In the section [Stick - Air-GCS Connection](#) of this manual, the user can find more information on configuring the **Stick** block for **real operation**.

- **If-Else Switch block**

This block is defined to write the control variables that are commanded by the stick:

- **Arc - Pitch**
- **Arc - Roll**
- **Arc - Yaw**
- **Arc - Throttle**

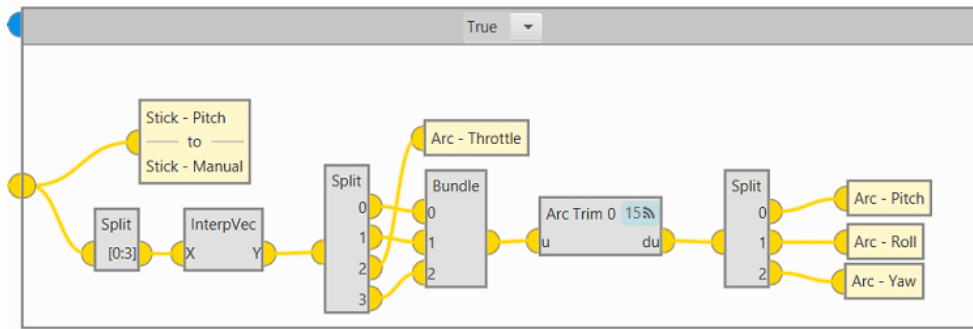

The behavior of this block depends on the value of the output Status of the Stick block. When this output is **True**, the output Y data of the Stick block is linked to this block as an entry and the transformation of the values of this output follows the following logic:

1. The **Split** block is used to transform the input vector to form one with the first four variables of the input vector.
2. This vector is interpolated with the **InterpVec** block.
3. With the **Split** and **Bundle** blocks, this vector is transformed into a three-component vector.
4. Finally, the vector is passed through the **Arc Trim** block and the variables are named by separating them with the **Split** block.

Control Mix

Control Mix - Program is based on the value of the IAS (Indicated Airspeed) to determine the **flight configuration** of the platform (**Multi or FW**). The program executes several IIR Filter calculations to determine the Control mix variable, which has a value from 0 to 1, and indicates the speed at which the platform should switch its flight configuration to FW.

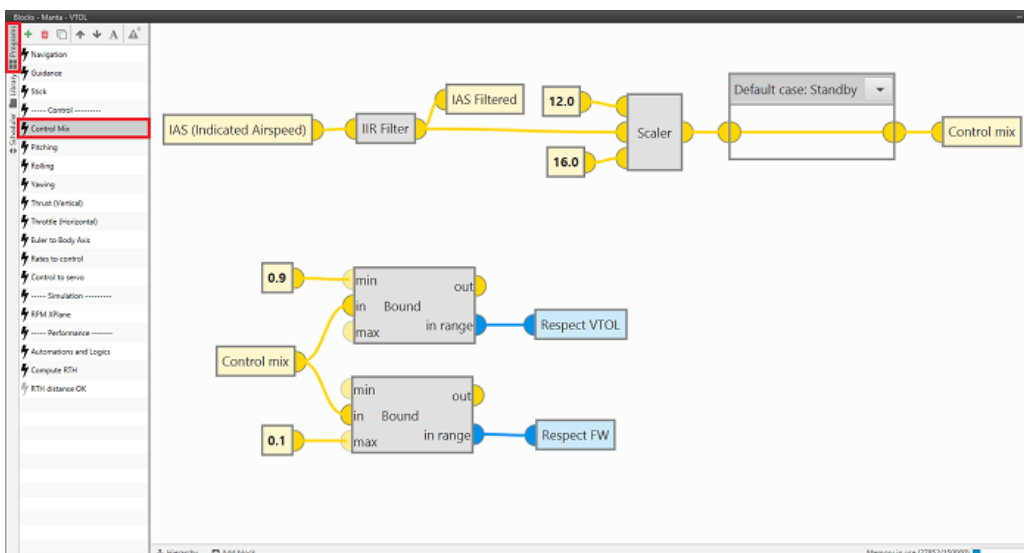

Control Mix - Program

Analytically, the following diagram shows the operation of the program, which provides a value to the Control mix variable depending on the value of the IAS.

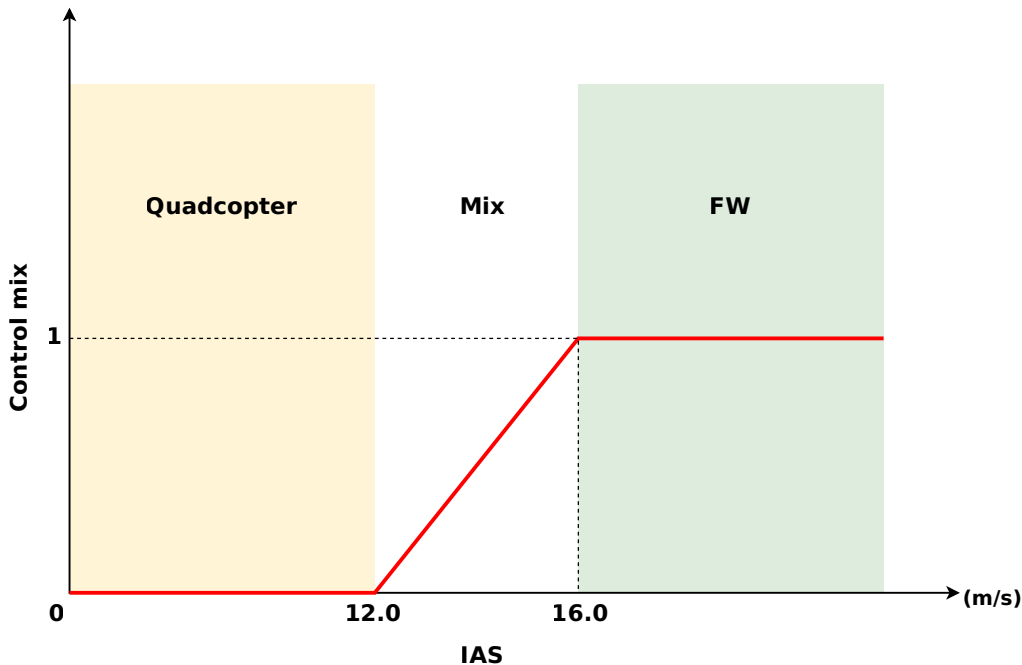

- **Control mix = 0** \Rightarrow indicates that the platform should adopt a quadcopter configuration.
- **$0 < \text{Control mix} < 1$** \Rightarrow indicates that the platform will operate in multicopter mode and in FW mode equally.
- **Control mix = 1** \Rightarrow indicates that the platform should adopt a FW configuration.

The operation of the program can be divided into two stages. A first stage in which, depending on the IAS, a value is assigned to the Control mix variable and a second stage in which, depending on the value of the Control mix variable, the flight configuration is determined.

1. Value of the variable

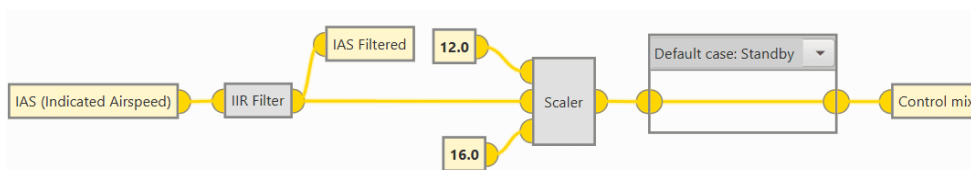

- To evaluate the IAS variable in a controlled way, the **IIR Filter block** is applied to it, which returns the IAS Filtered variable.

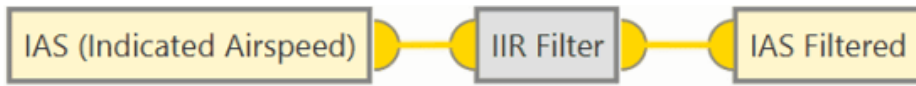

- The IAS Filtered variable is evaluated in the **Scaler** block. This block returns a value between 0 and 1, with respect to two limit values.

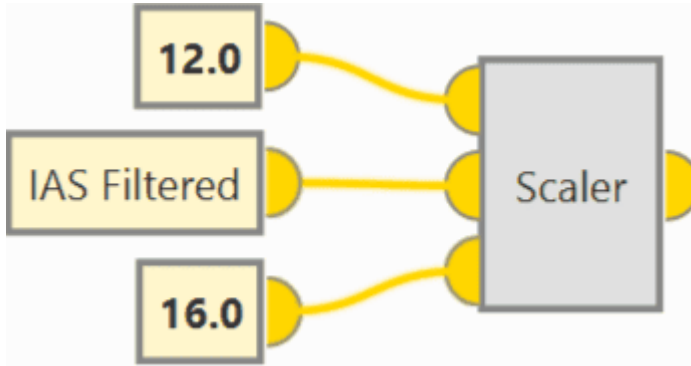

The **Scaler** block is a **custom** block located in the **Library**.

Scaler Block - Explanation

Scaler block rates the input value with respect to the range defined by the limit values (12 to 16).

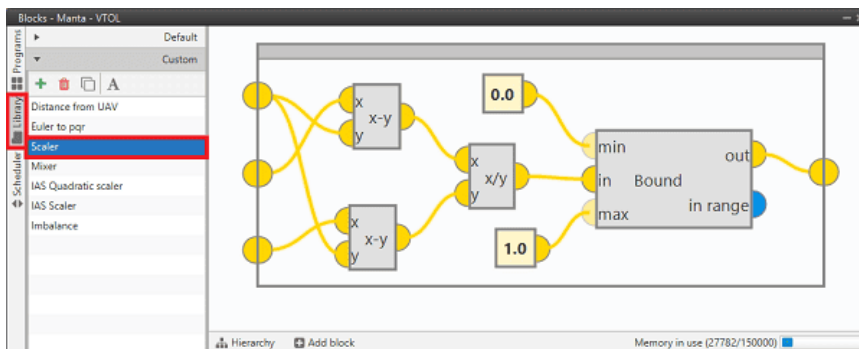

Scaler - Program

Bound block returns a maximum value **1** and a minimum value **0**.

- Depending on the flight phase, **Flight Control Check** or **Standby**, the Control mix variable is assigned.
 - **Standby:** In this flight phase the Control mix variable is the output value of the **Scaler** block.

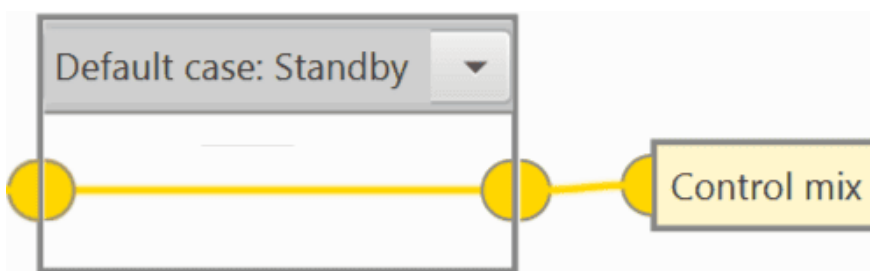

- **Flight Control Check:** In this flight phase, the Control mix variable has value **1.0** since it is necessary for the aircraft to act in FW configuration.

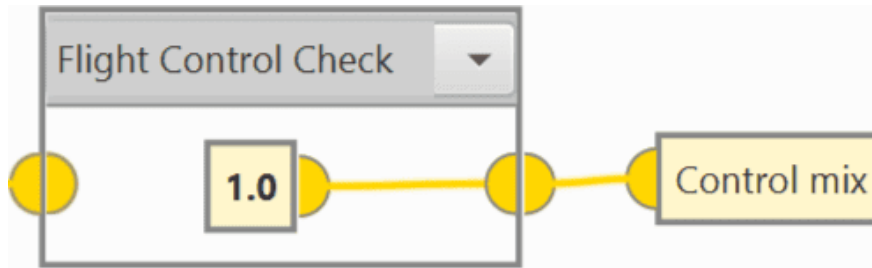

1. Flight configuration

This part of the program is used to keep stable the PID controllers that allow the control of the aircraft. This control is performed with the value of the Control mix variable.

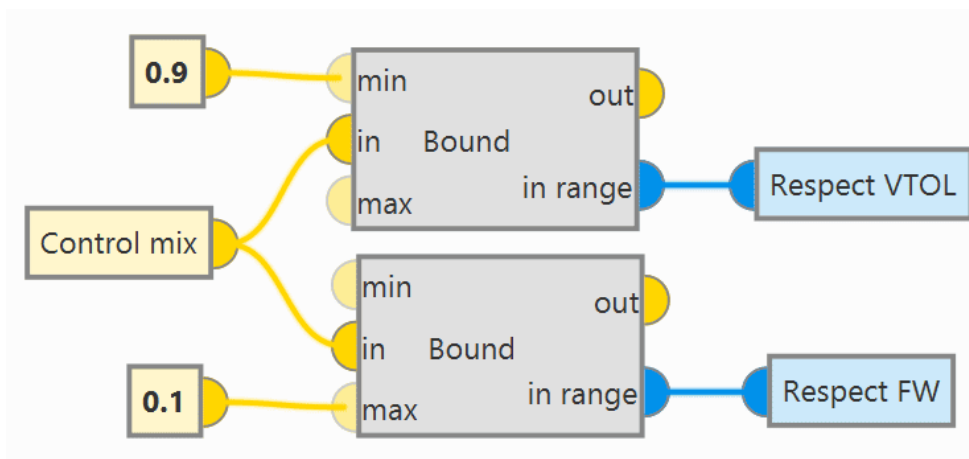

- If **Control mix** > **0.9**, Respect VTOL bit is true and the PID quadcopter controller is stabilized.
- If **Control mix** < **0.1**, Respect FW bit is true and the PID FW controller is stabilized.

Pitching

The following program is used to define the behavior and control of the aircraft to perform **Pitch**. The design of the program is made according to the flight phase, dividing the program into three groups of phases where the design of the control laws are similar.

- **Standby, Armed, Flight Control Check, Init**

In these flight phases, the aircraft does not require any design laws for pitch control since it is not flying.

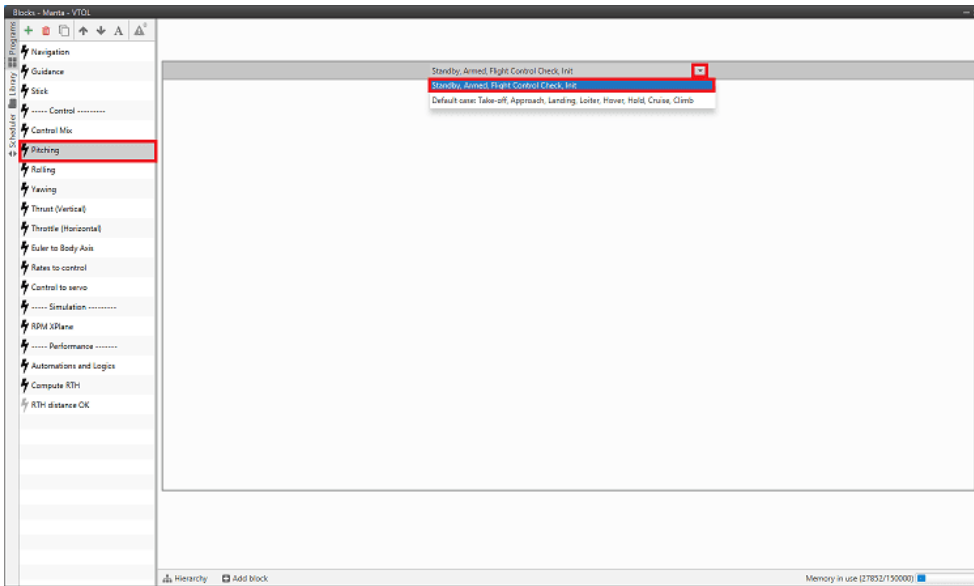

- **Take-off, Approach, Landing, Loiter, Hover, Cruise, Climb**

Pitch control will depend on the Control mix variable, since the aircraft flight configuration is essential in controlling the aircraft.

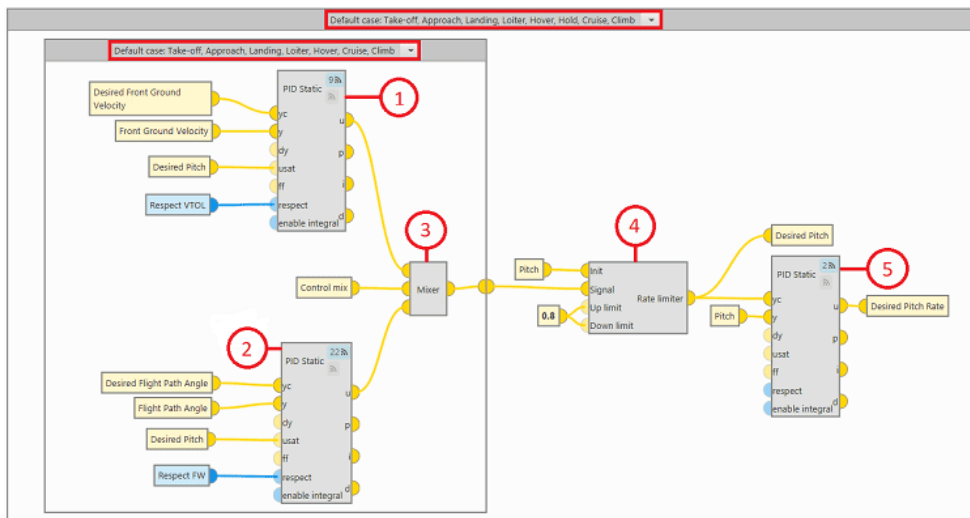

The program is basically controlled by 3 PID controllers, which provide the speed ratio as a function of the input variable and the desired variable.

1. The PID controller is defined for **quadcopter** flight configuration.

In the **quadcopter** configuration, Pitch is performed to be able to control the **Front Ground Velocity**, so this velocity will be the input variable in the PID controller.

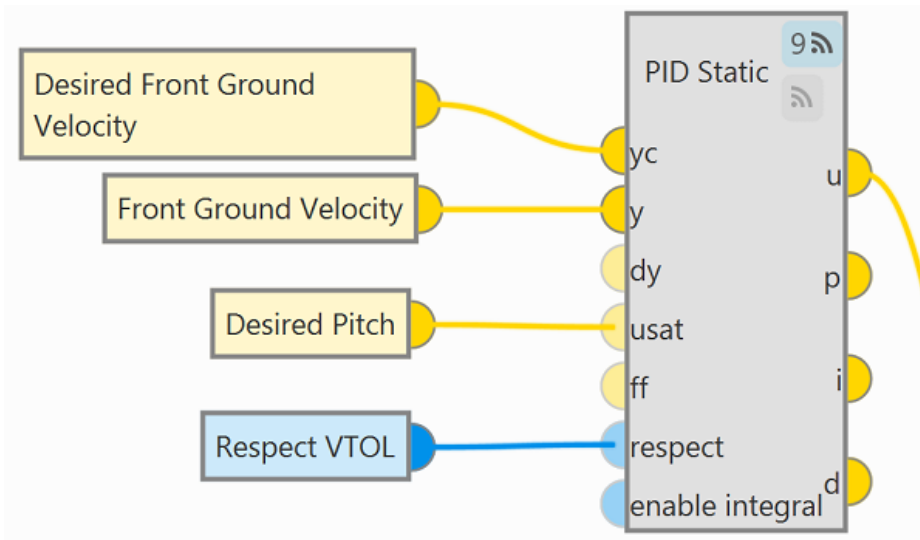

Important

When the **Respect VTOL** bit (set in the [Control Mix program](#)) is true, the **u** output of the **PID block** is equal to the **usat** input. That is, when the bit is true, the output of the **PID block** will be the output variable of the [Rate limiter block](#), Desired Pitch.

- The **PID** controller is defined for the **FW** flight configuration. In **FW** configuration, Pitch is performed to control the **Flight Path Angle**, so this variable will be the input variable in the **PID** controller.

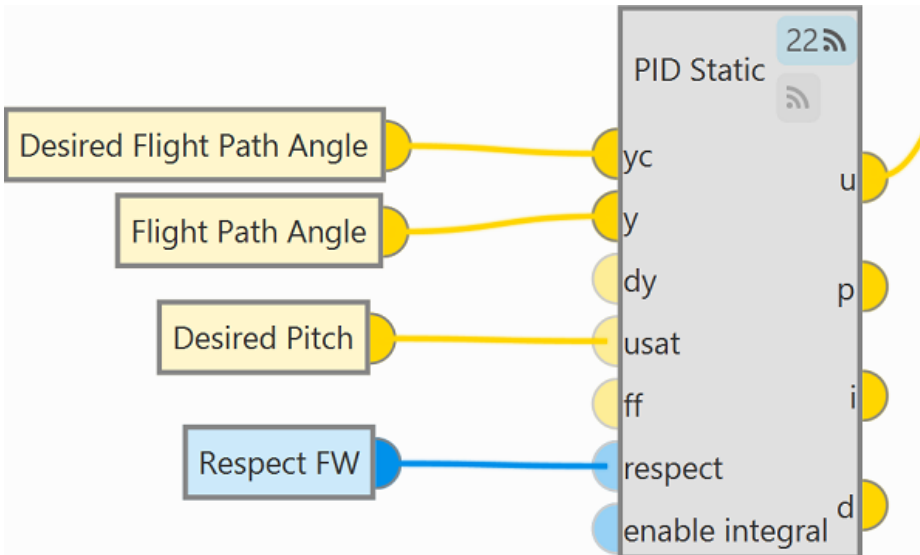

Important

When the **Respect FW** bit (set in the [Control Mix program](#)) is true, the **u** output of the [PID block](#) is equal to the **usat** input. That is, when the bit is true, the output of the [PID block](#) will be the output variable of the [Rate limiter block](#), Desired Pitch.

3. **Mixer** block provides the output signals of the above [PID](#) controllers depending on the Control mix variable.

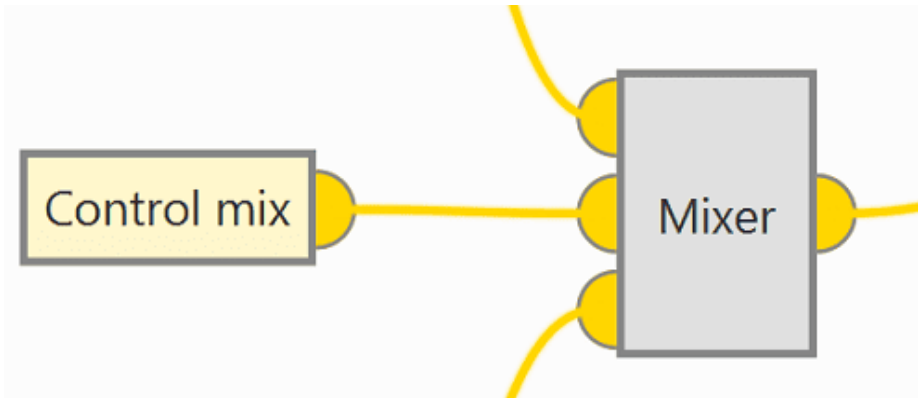

Mixer block is a **custom** program located in the **Library**.

Mixer Block - Explanation

Mixer block implements the following relationship between input variables and output variables.

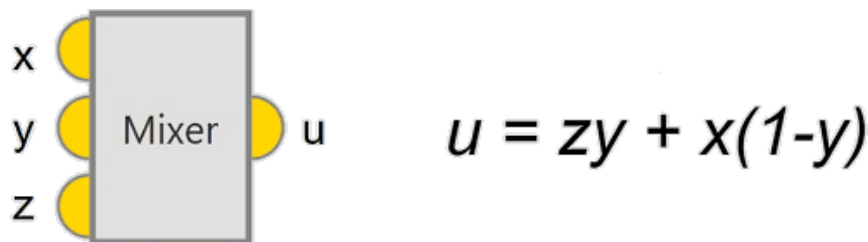

For more information on custom blocks, visit the [Library blocks - Block Programs](#) section of the **1x PDI Builder** user manual.

4. The [Rate limiter block](#) is defined to adjust the input signal to a **controlled gain**.

This block limits the rate of change of the variable by limiting the rate of rise and fall of the variable. The purpose is to achieve a controlled rate of change that allows safe operation of the aircraft.

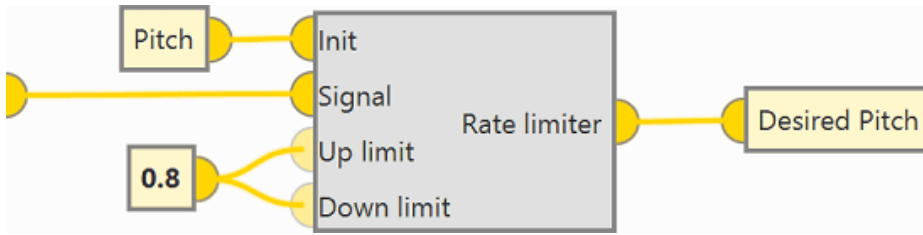

5. A **PID** controller is defined giving the **Desired Pitch Rate**.

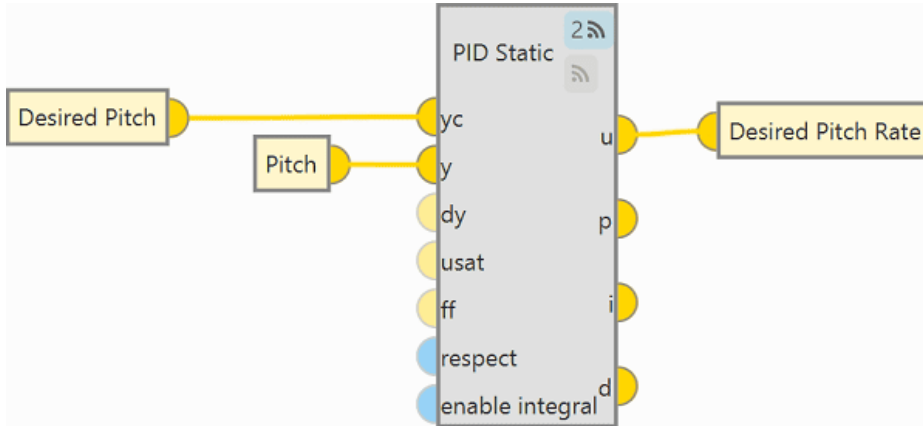

- **Hold**

In this flight phase, the output of the **PID** controller is the **Desired Pitch Rate**. Since this flight phase is intended to keep the aircraft **attitude constant**, no **PID** controller is defined to provide a rate of change.

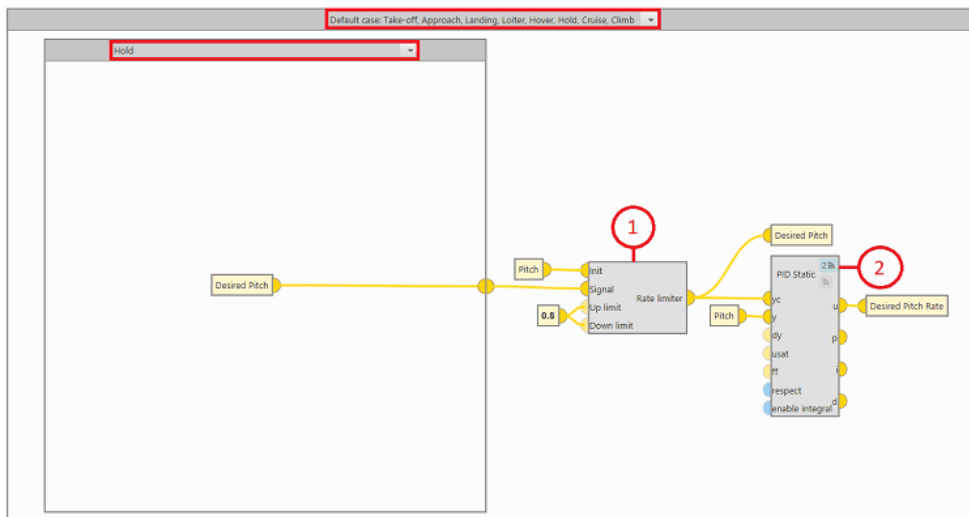

1. The **Rate limiter** block is defined to adjust the input signal to a controlled gain.

This block limits the rate of change of the variable by limiting the rate of rise and fall of the variable. The objective is to achieve a controlled rate of change that allows safe operation of the aircraft.

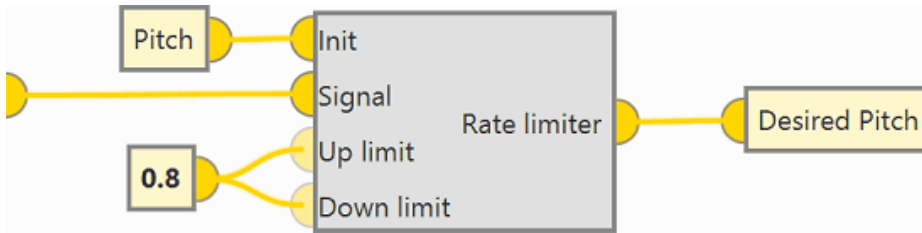

The Signal input variable of the **Rate limiter block**, Desired Pitch, is generated by the **Guidance program**. In the Hold flight phase it is intended to stabilize the aircraft attitude, that is why the Desired Pitch control is independent of the flight configuration.

2. A **PID** controller is defined giving the **Desired Pitch Rate** variable.

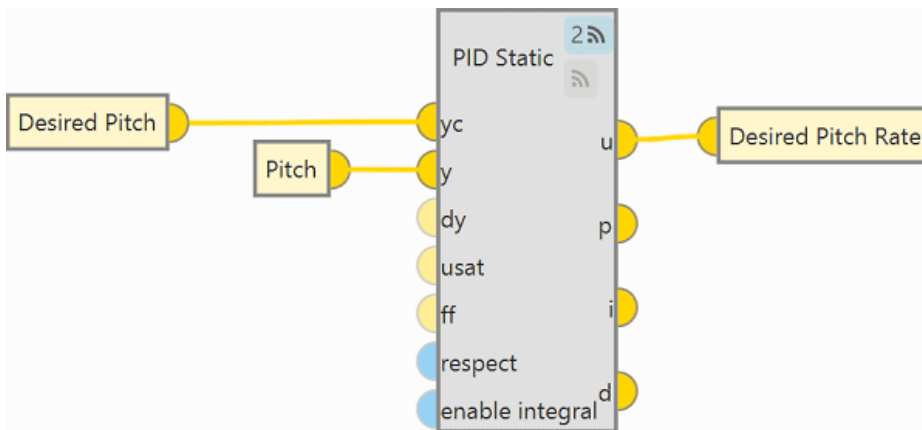

Rolling

The following program is used to define the behavior and control of the aircraft to perform **Roll**. The logic of the program design is similar to the one used in the **program to control the Pitch**, it is done according to the flight phase in which the aircraft is, dividing the program into four groups of phases where the design of the control laws are similar.

Important

The effect on the aircraft when rolling depends on the flight configuration in which it is flying.

If rolling is performed flying in **quadcopter configuration**, the effect on the aircraft is the variation of the **Lateral Ground Velocity** and if rolling is performed flying in **FW configuration** the effect on the aircraft is the variation of the **Heading**.

• **Standby, Armed, Flight Control Check, Init**

In these flight phases, the aircraft does not require any design laws for roll control since it is not flying and is therefore at rest with respect to the ground.



• **Approach, Loiter, Cruise, Climb**

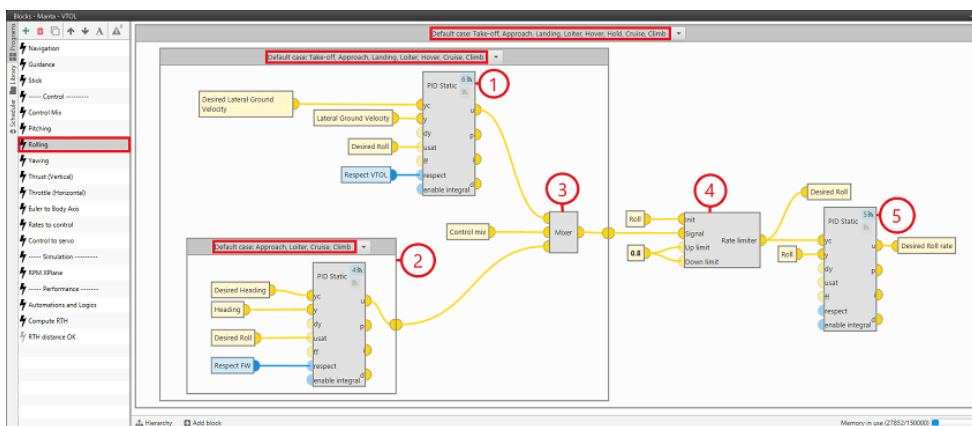

The program is basically controlled by 3 PID controllers, which provide the speed ratio as a function of the input variable and the desired variable.

1. PID controller for **quadcopter** flight configuration.

In **quadcopter** configuration, Roll is performed to be able to control the **Lateral Ground Velocity**, so this velocity will be the input variable in the **PID** controller.

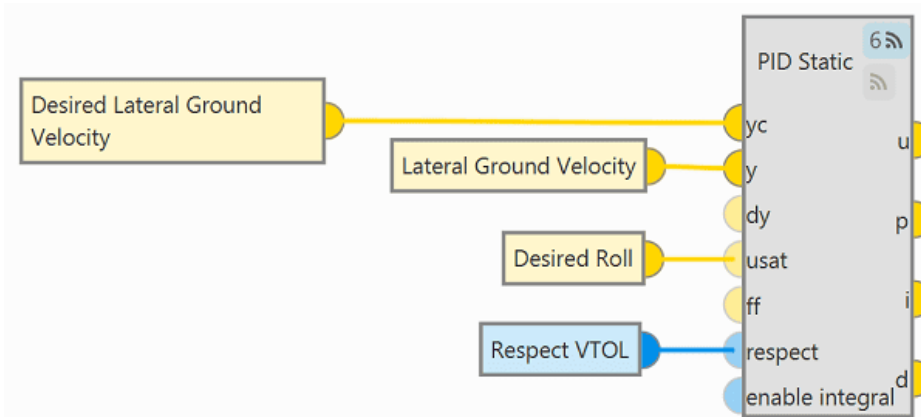

Important

When the **Respect VTOL** bit (set in the [Control Mix program](#)) is true, the **u** output of the **PID block** is equal to the **usat** input. That is, when the bit is true, the output of the **PID block** will be the output variable of the [Rate limiter block](#), **Desired Roll**.

2. **PID** controller for **FW** flight configuration.

In **FW** configuration, Roll is performed to control the **Heading**, so this variable will be the input variable in the **PID** controller.

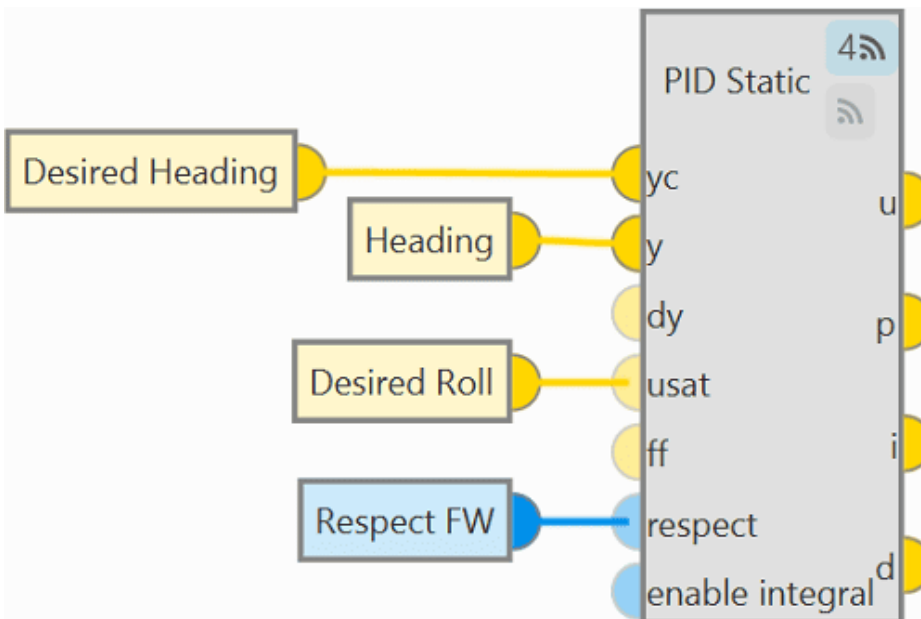

Important

When the **Respect FW** bit (set in the [Control Mix program](#)) is true, the **u** output of the [PID block](#) is equal to the **usat** input. That is, when the bit is true, the output of the [PID block](#) will be the output variable of the [Rate limiter block](#), Desired Roll.

- Mixer** block provides the output signals of the above [PID](#) controllers depending on the Control mix variable.

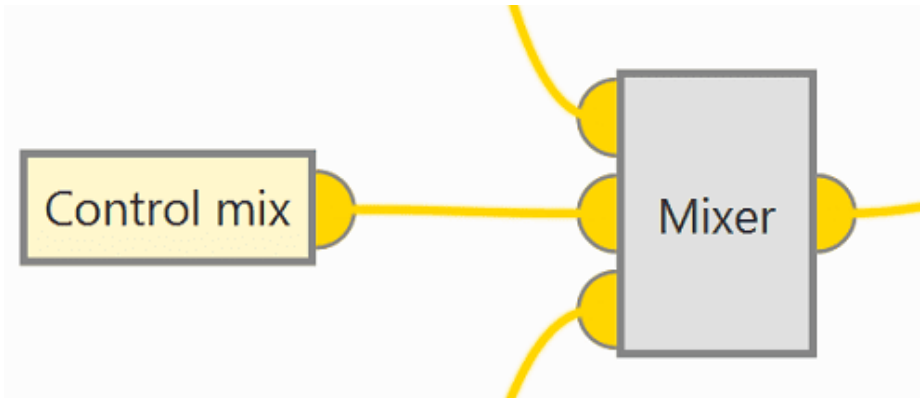

Mixer block is a **custom** program located in the **Library**.

Mixer Block - Explanation

Mixer block implements the following relationship between input variables and output variables.

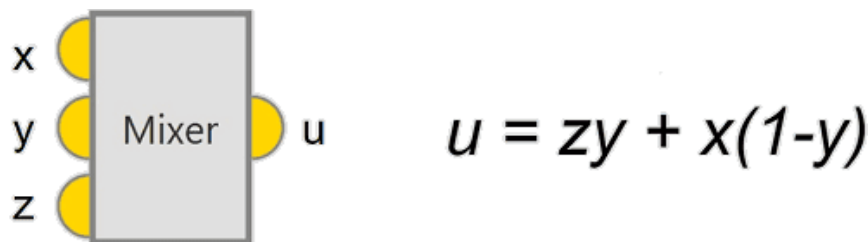

For more information on custom blocks, visit the [Library blocks - Block Programs](#) section of the **1x PDI Builder** user manual.

- [Rate limiter block](#) is defined to adjust the input signal to a **controlled gain**.

It limits the rate of change of the variable controlled by the [PID](#) by limiting the rate of rise and fall of the variable. The purpose is to achieve a controlled rate of change that allows safe operation of the aircraft.

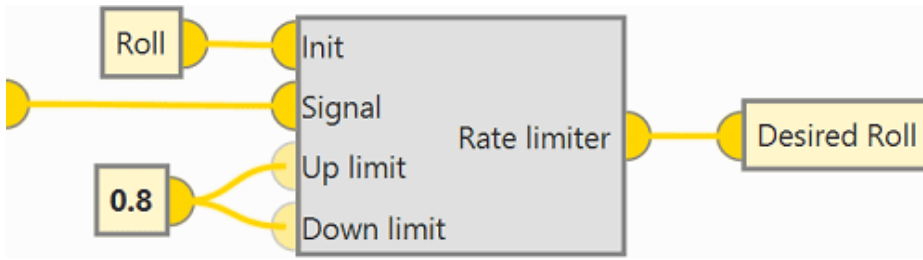

5. **PID** controller giving the **Desired Roll rate**.

This controller will provide the rate of change of the **Roll** variable.

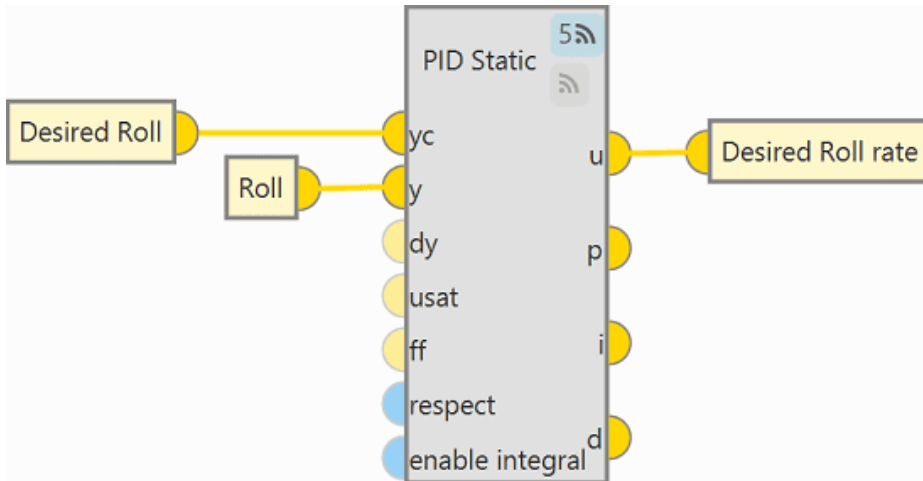

• **Take-off, Landing, Hover**

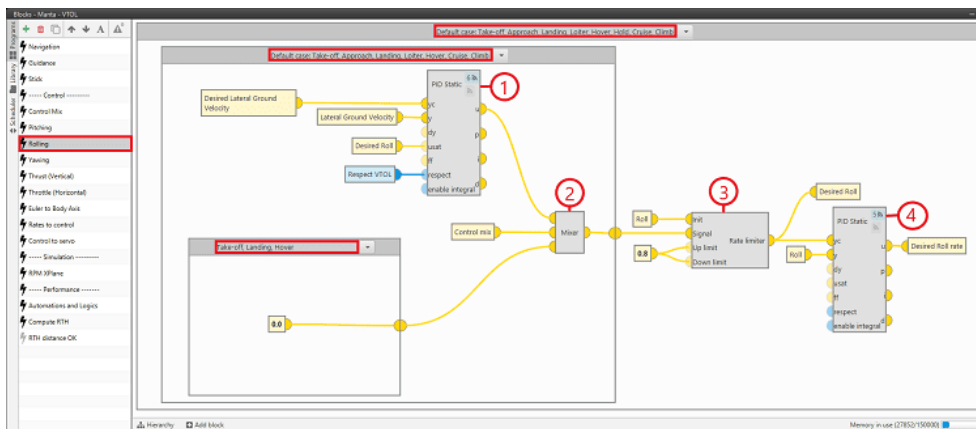

In these flight phases the **FW** flight configuration is not taken into account, since **these flight phases must be performed in quadcopter configuration**. For this reason, **no PID** controller is defined to control the **Heading**.

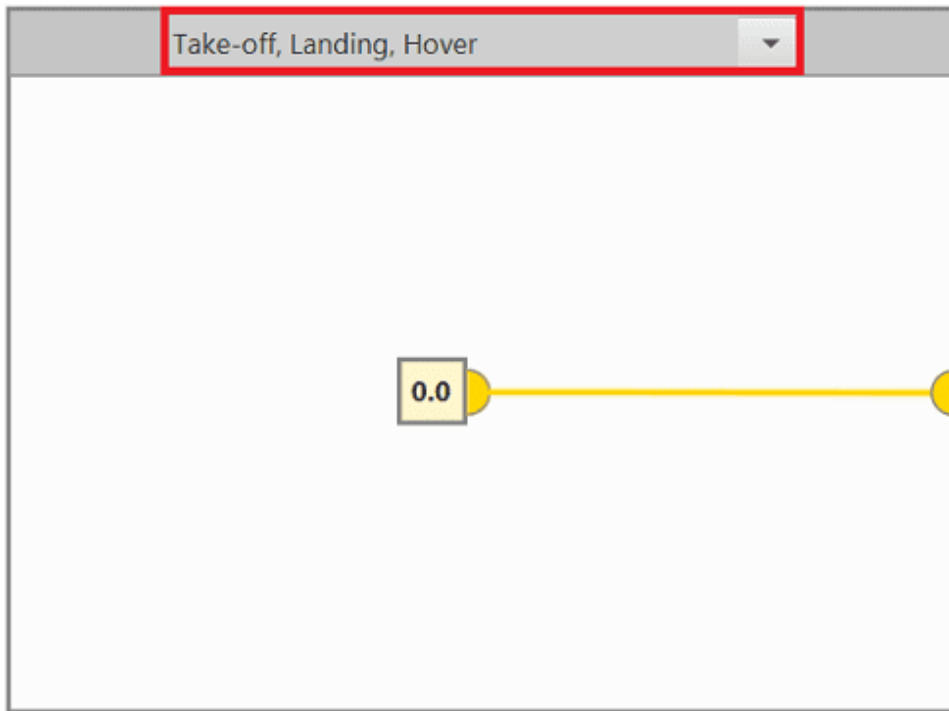

1. **PID** controller for **quadcopter** flight configuration.

This controller will provide the rate of change of the Lateral Ground Velocity variable.

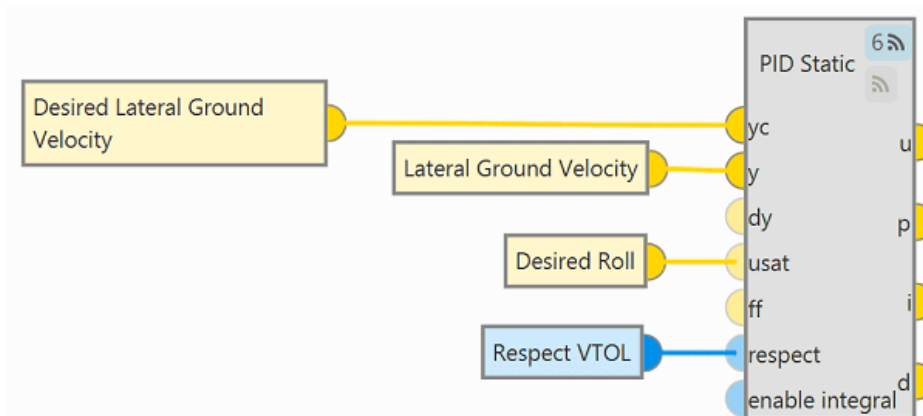

Important

When the **Respect VTOL** bit (set in the [Control Mix program](#)) is true, the **u** output of the **PID block** is equal to the **usat** input. That is, when the bit is true, the output of the **PID block** will be the output variable of the [Rate limiter block](#), Desired Roll.

2. **Mixer** block provides the output signal of the above **PID** controller depending on the Control mix variable.

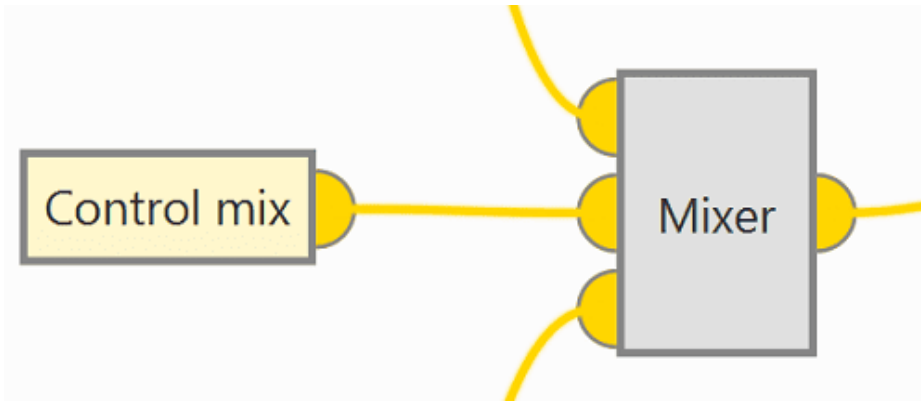

3. **Rate limiter block** is defined to adjust the input signal to a **controlled gain**.

It limits the rate of change of the variable controlled by the **PID** by limiting the rate of rise and fall of the variable. The purpose is to achieve a controlled rate of change that allows safe operation of the aircraft.

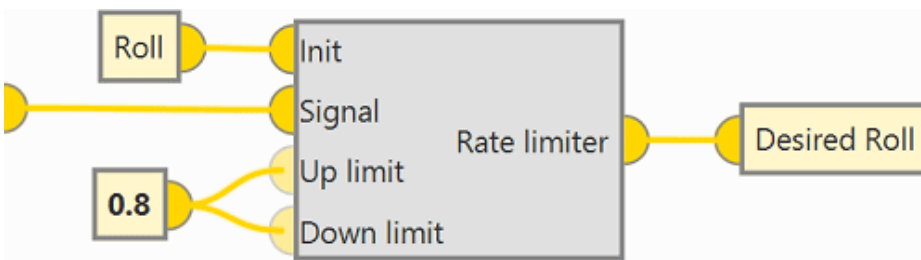

4. **PID controller** giving the control variable **Desired Roll rate**.

This controller will provide the rate of change of the **Roll** variable.

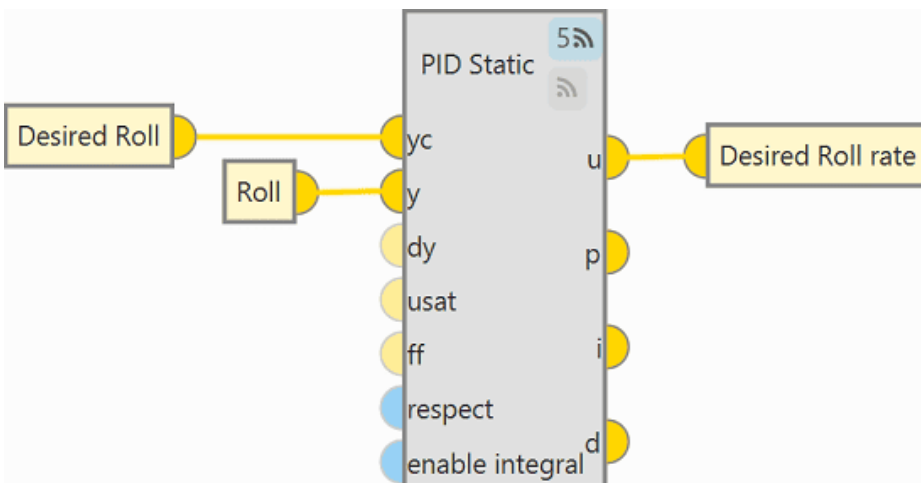

- **Hold**

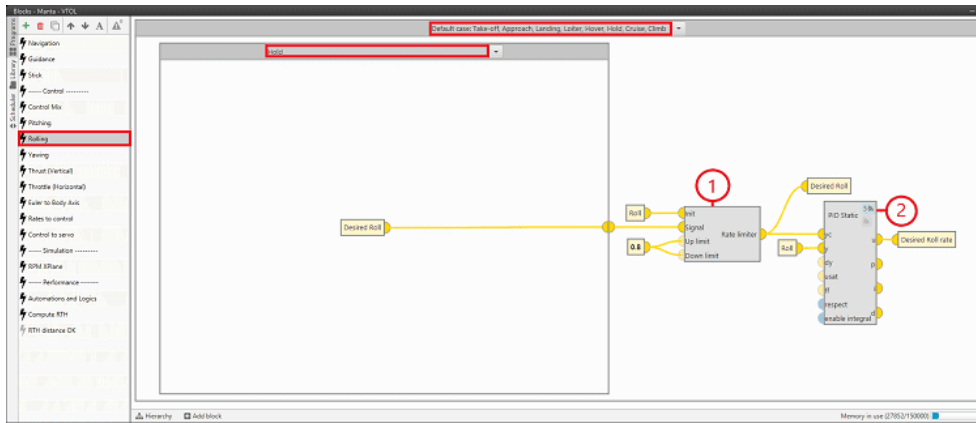

In this flight phase it is **not necessary** to define the **Roll control**, since it is intended to keep a **constant attitude** of the aircraft, so the value of the **Desired Roll** variable will come directly from the [Guidance program](#).

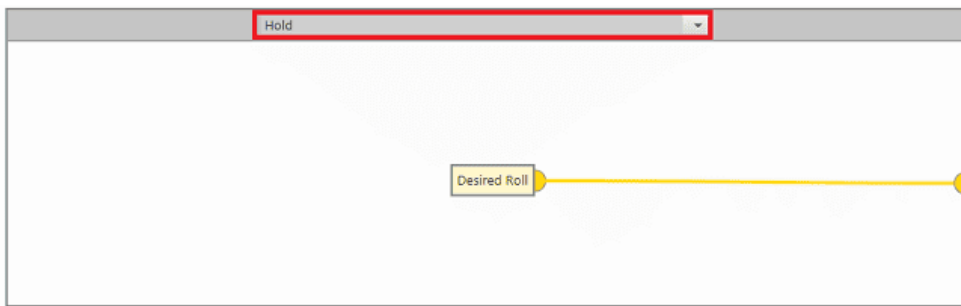

1. [Rate limiter block](#) is defined to adjust the input signal to a **controlled gain**.

It limits the rate of change of the variable controlled by the [PID](#) by limiting the rate of rise and fall of the variable. The objective is to achieve a controlled rate of change that allows safe operation of the aircraft.

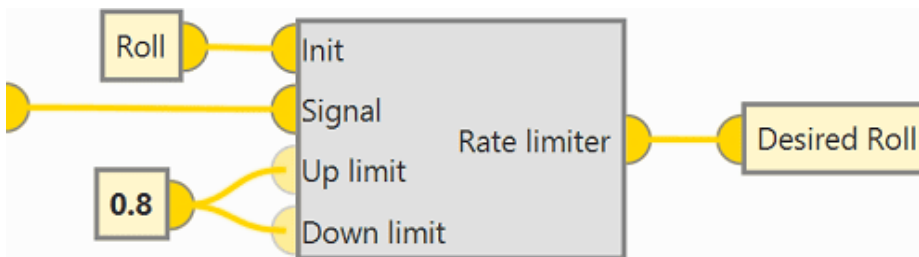

2. [PID](#) controller giving the control variable **Desired Roll rate**.

This controller will provide the rate of change of the **Roll** variable.

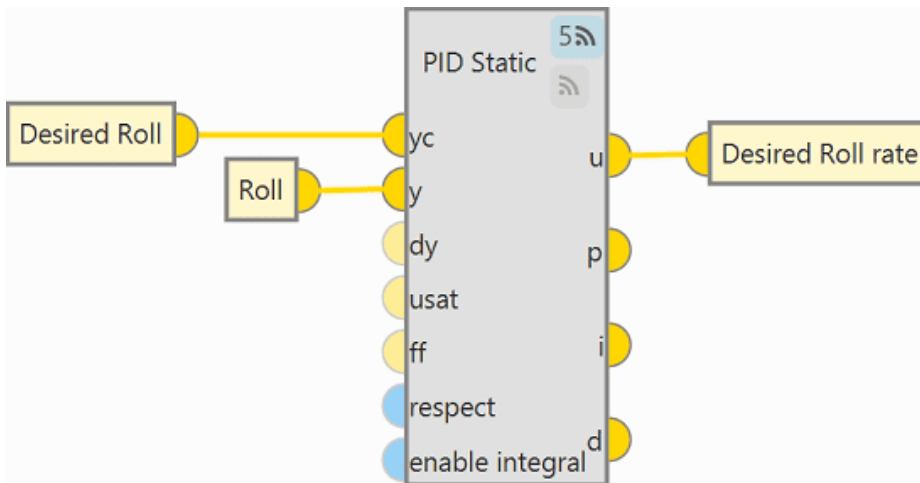

Yawing

As with the **Pitching** and **Rolling** programs, the program to control the **Yaw** is performed depending on the phase of flight in which it is flying.

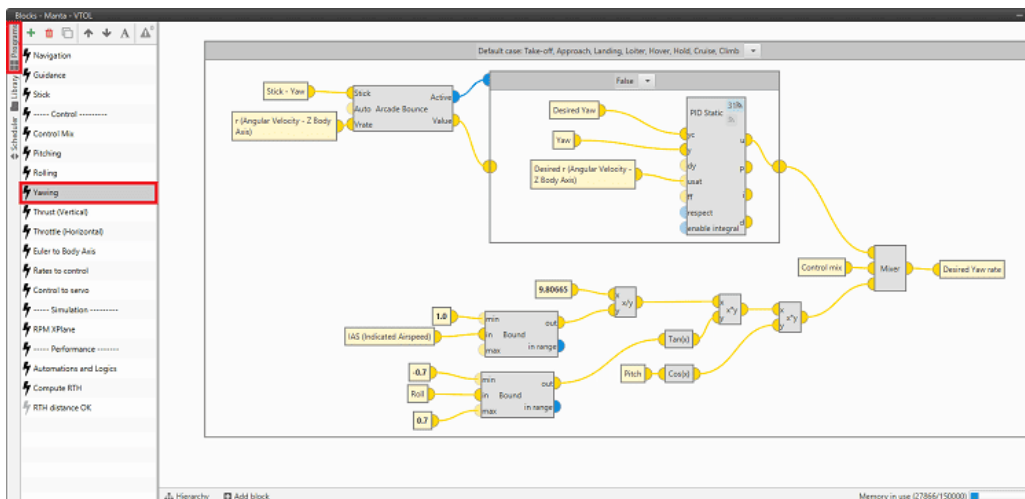

- **Standby, Armed, Flight Control Check, Init**

For these flight phases no definition of the yaw control program is required as they are phases where the aircraft is not flying.

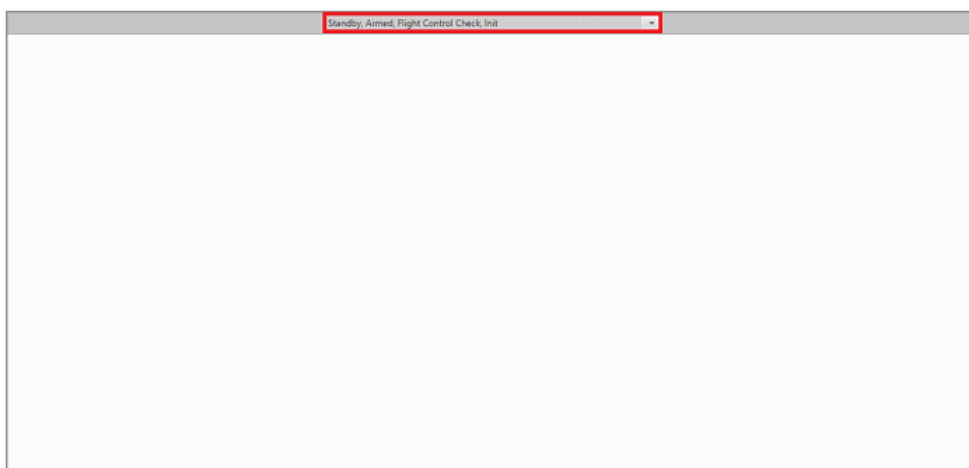

• **Take-off, Approach, Landing, Loiter, Hover, Hold, Cruise, Climb**

In these flight phases, **Yaw** control is performed depending on the aircraft flight configuration, quadcopter or FW. For this reason, it is necessary to define two control paths, one to control the Yaw when the aircraft flies at **low speeds (Multi)** and another one when the aircraft flies at **high speeds** and, therefore transitions to the **Fixed Wing (FW)** flight configuration.

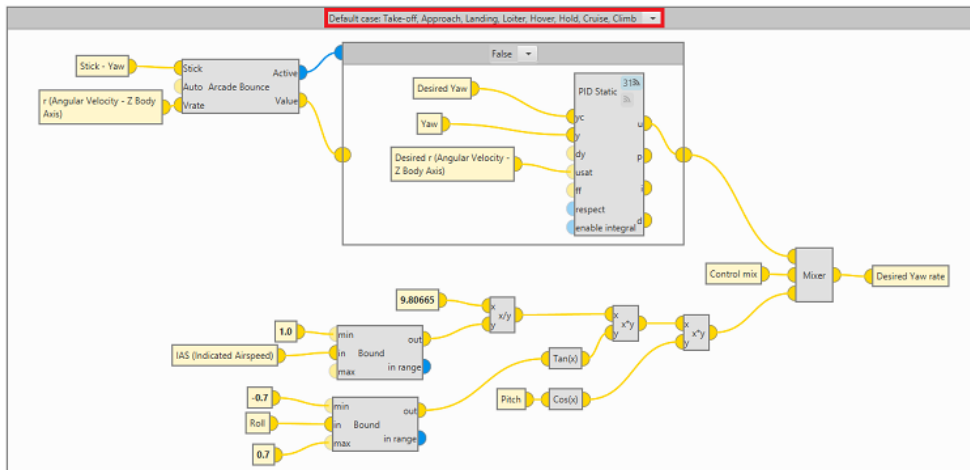

The program logic has been divided into three sections/parts. Two of them to define the aircraft control according to the flight configuration and, once these controls are defined, in the third section of this program, the output signals of both are provided to the Control mix variable by means of the **Mixer** block.

1. **Quadcopter control**

• **False**

In this case, Autopilot 1x is controlled in **Auto** mode, so the **Arcade Bounce block** will return a **false** bit. Therefore, **Yaw** control is performed with a **PID** controller.

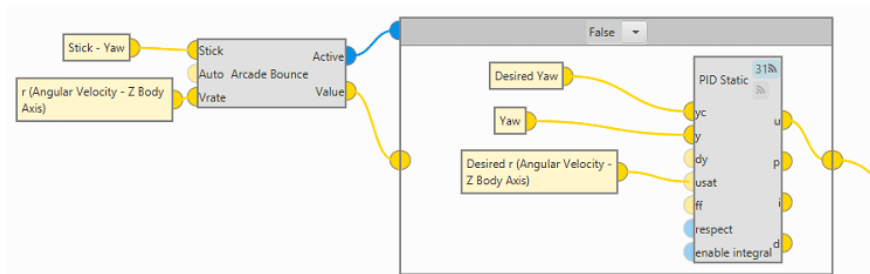

• **True**

In this case, Autopilot 1x takes into account the Stick input in the **Arcade Bounce** block and returns a **true** bit. Therefore, the value of the **Desired Yaw rate** is the one commanded by the stick entry.

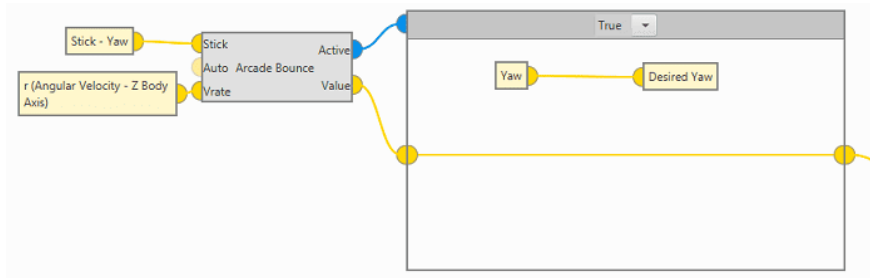

2. FW control

In FW configuration, the turns do not depend only on the yaw as in quadcopter configuration, but also on the roll and pitch to perform a coordinated turn, hereafter called "Coordinate Turn". The following algorithm represents this **Coordinate Turn** performed by the aircraft:

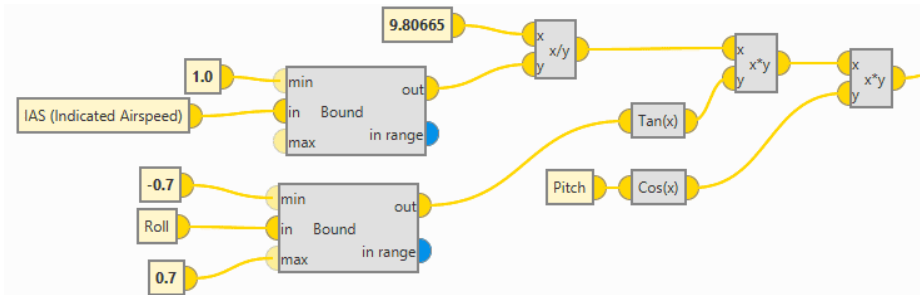

Bound block limits the **IAS** and **Roll** values. The minimum value for the **IAS** is 1.0 *m/s* , and the value for the **Roll** angle should be between $[-0.7, 0.7]$ *rad* .

3. Mix control

Mixer block has as inputs the output signals of the previous controls and the Control mix variable. In this way, the block selects which configuration controls the aircraft, providing the **Desired Yaw rate** value.

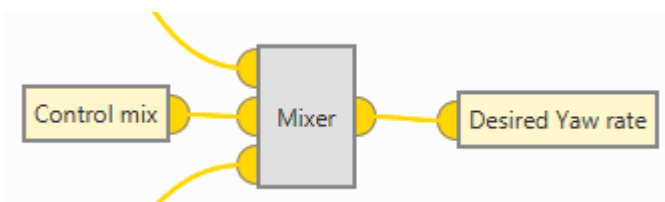

Mixer block is a **custom** program located in the **Library**.

Mixer Block - Explanation

Mixer block implements the following relationship between input variables and output variables.

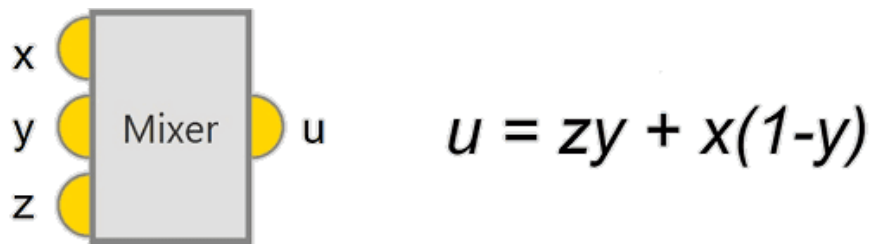

For more information on custom blocks, visit the [Library blocks - Block Programs](#) section of the **1x PDI Builder** user manual.

Thrust (Vertical)

Explanation

Thrust program is defined to control the **vertical thrust** of the aircraft. For this purpose, the motors involved are the vertical ones, which allow the aircraft to fly in **quadcopter** configuration.

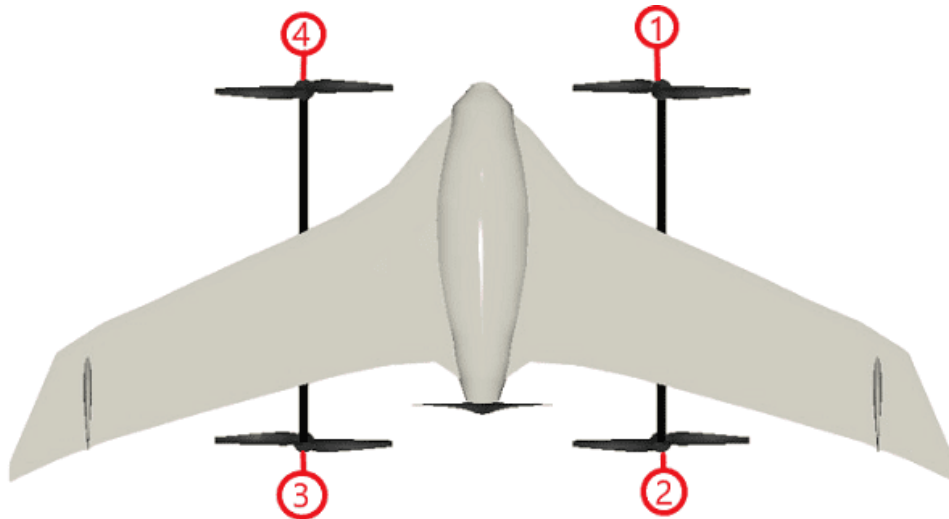

Thrust actuation is performed with the use of **Channel 1**. This channel is controlled with the [Manual block](#), which is configured to process thrust control depending on the control mode. This block switches between two input signals according to the current mode of the configured channel.

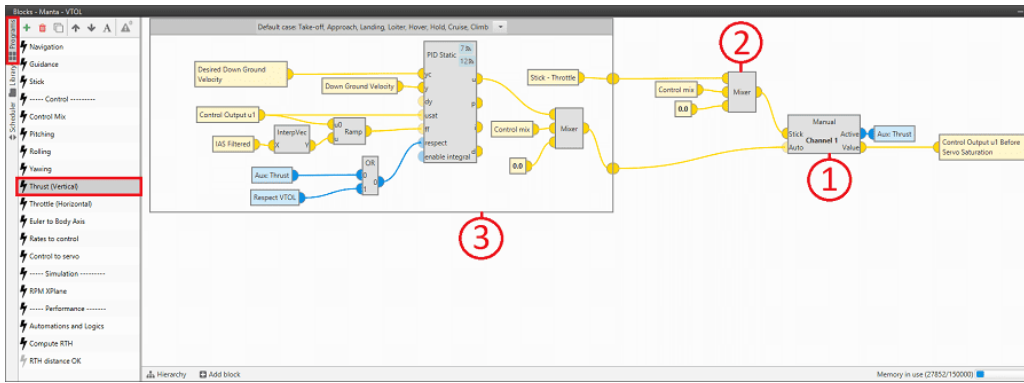

Thrust (Vertical) - Program

1. The **Manual** block receives two input signals, Stick and Auto and provides two output signals, Value, which depends on the flight mode, and Active.

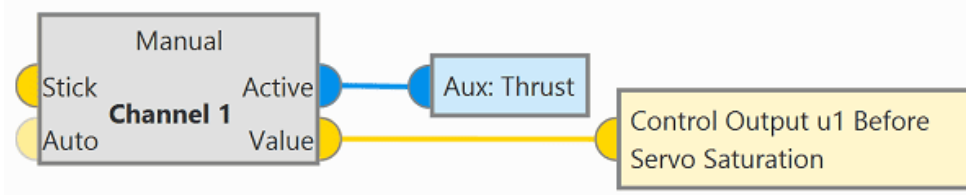

The Value output of this block must be linked to the Control Output u1 Before Servo Saturation variable, since this variable controls the actuation of the Thrust defined in the **Actuator** block.

Moreover, the Aux: Thrust bit is **true** when the Autopilot 1x is **not controlled by the stick**.

2. The **Mixer** block provides the value for the Stick input to the **Manual** block as a function of the Control mix variable. This is a **custom** block located in the **Library**.

Mixer Block - Explanation

Mixer block implements the following relationship between input variables and output variables:

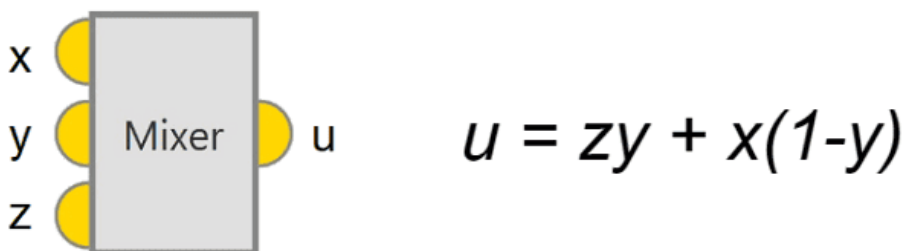

For more information on custom blocks, visit the [Library blocks - Block Programs](#) section of the **1x PDI Builder** user manual.

As the Control mix variable indicates the control rate of the aircraft in FW flight configuration, only the part proportional to the rate controlled in quadcopter configuration is maintained.

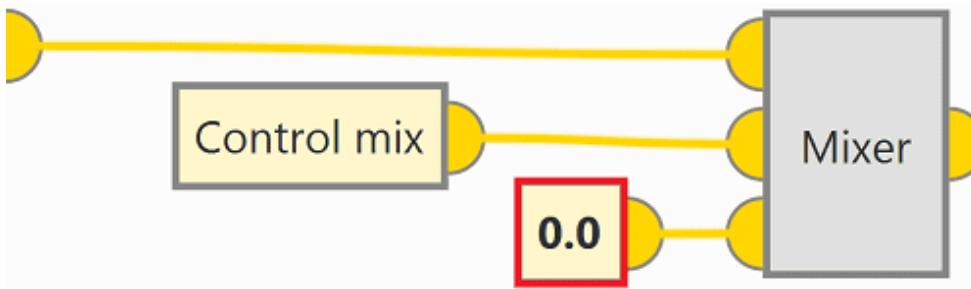

3. The input variable Auto to the **Manual** block and the input variable to the **Mixer** block, which corresponds to the **quadcopter** configuration, depends on the flight phase:

- **Standby, Flight Control Check, Init**

Since no Thrust action is required in these flight phases, the values for the Stick and Auto inputs are set to **0.0**. Therefore, the output value of the **Manual** block is null. This is because the Control Output u1 Before Servo Saturation variable must be null regardless of the flight control mode.

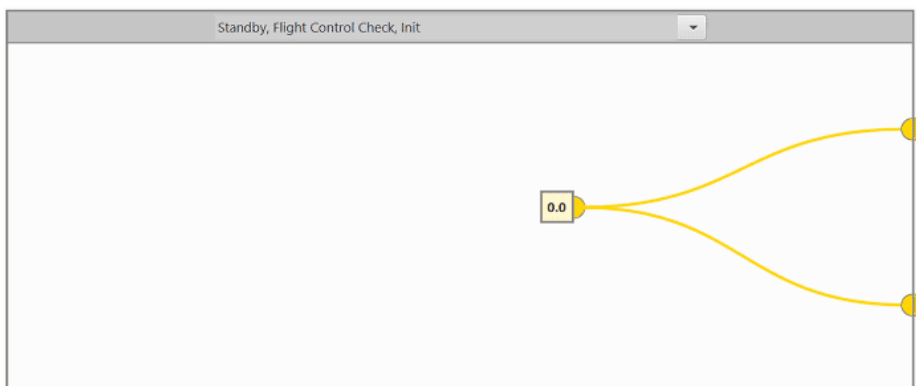

- **Armed**

In the Armed flight phase, the Autopilot 1x automatically activates the aircraft's four motors up to **25%** of their **maximum RPM**.

Note

This RPM value is not sufficient to lift the aircraft, it only activates the motors.

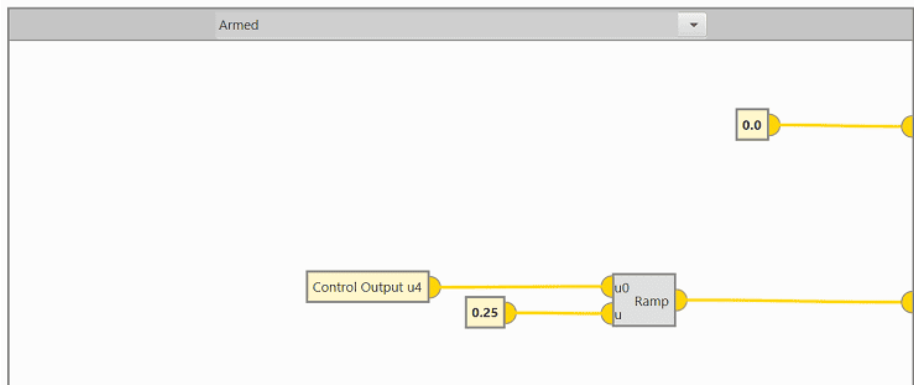

- **Stick input:** This value remains zero since in this flight phase the **aircraft is only controlled in auto mode**.
- **Auto input:** Corresponds to the output of the [Ramp block](#). This block is used to activate the motors at 25% of their maximum RPM, as it allows to control the rate of change of the Control Output u4 variable.
- **Take-off, Approach, Landing, Loiter, Hover, Hold, Cruise, Climb**

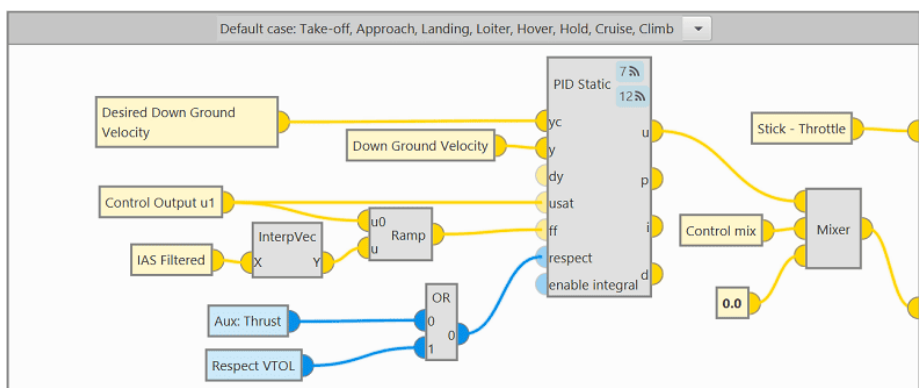

- **Stick input:** This value is defined as the part of the **Stick-Throttle** variable that is controlled by the quadcopter.
- **Auto input:** The Auto input is written by the **Mixer** block. This block receives 3 input signals, 2 of them correspond to the Thrust control in **quadcopter (1)** and **FW (2)** flight configurations, and the value of the third input is the variable Control mix written by the [Control Mix program](#).
 1. The control signal in the **quadcopter flight configuration** is defined with a [PID](#) controller.
 2. The control signal in the **FW flight configuration** is **zero** since no Thrust control is performed in this flight configuration.

Throttle (Horizontal)

Explanation

Throttle program is defined to control the **horizontal thrust** of the aircraft. For this purpose, pusher motor is involved, which allow the aircraft to fly in **FW** configuration.

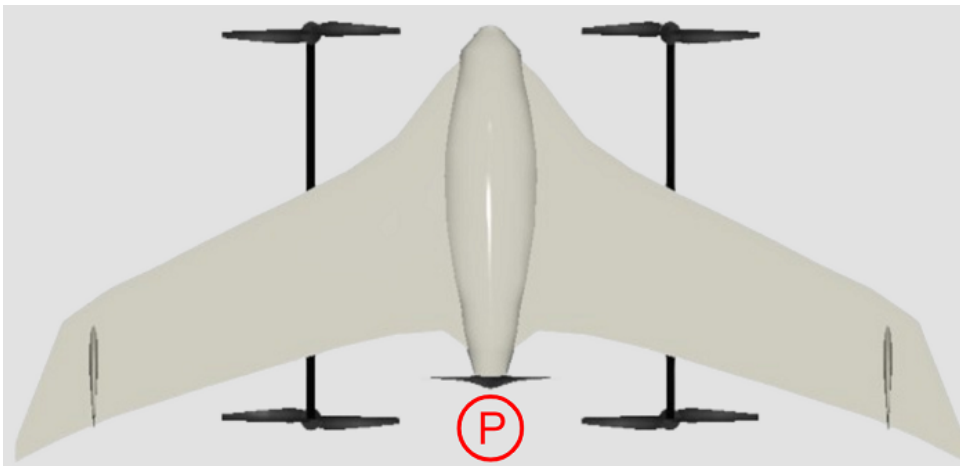

Throttle actuation is performed with the use of **Channel 5**. This channel is controlled with the **Manual** block, which is configured to process throttle control depending on the control mode. This block switches between two input signals according to the current mode of the configured channel.

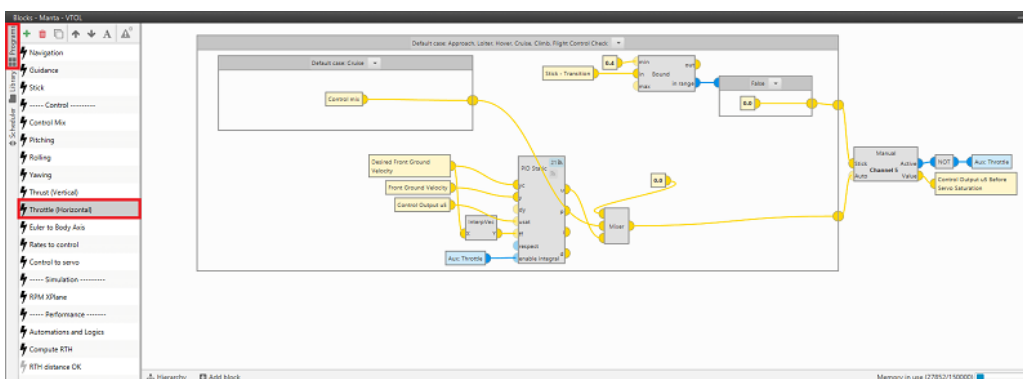

Throttle (Horizontal) - Program

The **Manual** block receives two input signals, Stick and Auto and provides two output signals, Value, which depends on the flight mode, and Active.

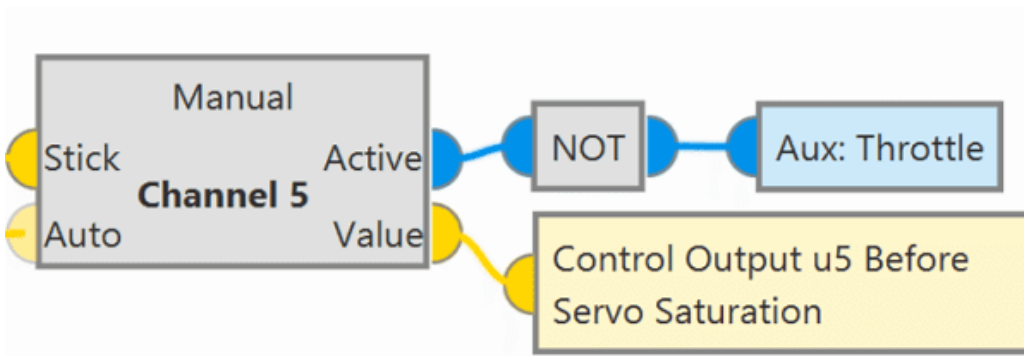

The Value output of this block must be linked to the Control Output u5 Before Servo Saturation variable, since this variable controls the actuation of the Throttle defined in the [Actuator block](#).

Moreover, the Aux: Throttle bit is **true** when the Autopilot 1x is **not controlled by the stick**.

The input variables, Stick and Auto, are different depending on the flight phase:

- **Standby, Take-off, Landing, Init**

Since no Throttle action is required in these flight phases, the values for the Stick and Auto inputs are set to **0.0**. Therefore, the output value of the [Manual block](#) is null.

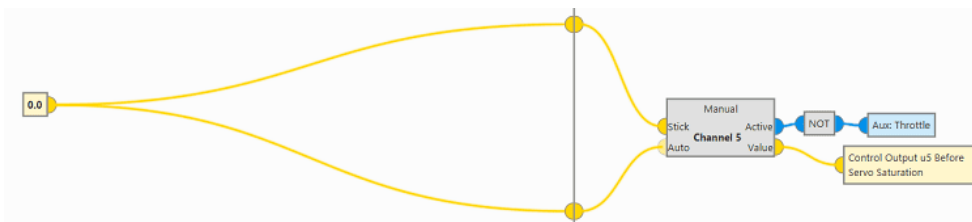

- **Approach, Loiter, Hover, Cruise, Climb, Flight Control Check**

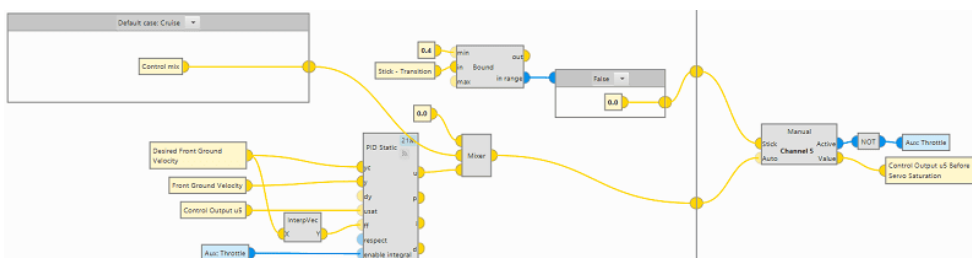

- **Stick input**

If the Stick-Transition variable has a value **greater than 0.4** \Rightarrow in range bit will be **true** and the Stick input of the **Manual** block will be written by the Stick-Throttle variable.

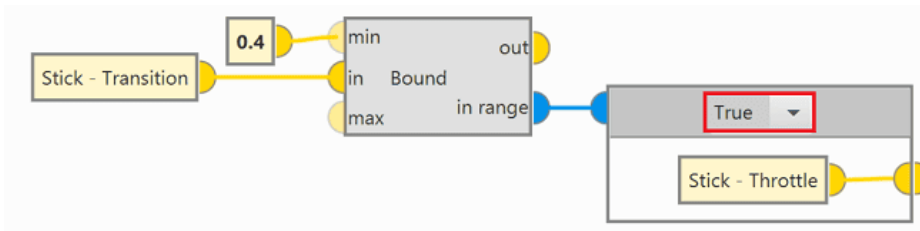

Otherwise, if this variable has a value **less than 0.4** \Rightarrow in range bit will be **false** and the Stick input will have a value of **0.0**.

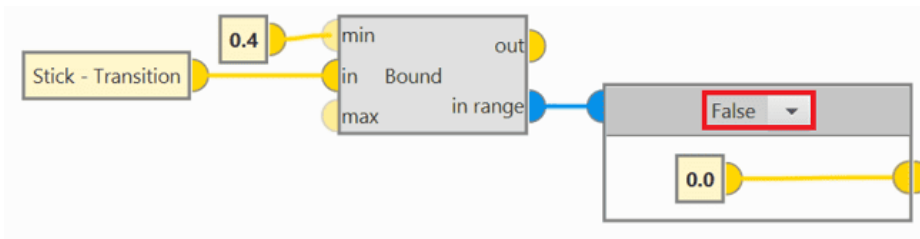

i Note

The Stick-Transition variable represents the position of the Stick command that defines the aircraft control mode. This command has two values: **1** for control of the aircraft using the **stick pilot**, and **0** for control of the aircraft in **Auto** mode, i.e., with Autopilot 1x.

◦ Auto input

The Auto input is written by the **Mixer** block. This block receives 3 input signals, 2 of them correspond to the Throttle control signals in **quadcopter (1)** and **FW (2)** flight configurations, and the value of the third signal (**3**) will be different depending on the flight phase.

1. The control signal in the **quadcopter flight configuration** is **zero** since no Throttle control is performed in this flight configuration.
2. The control signal in the **FW flight configuration** is defined with a **PID** controller.

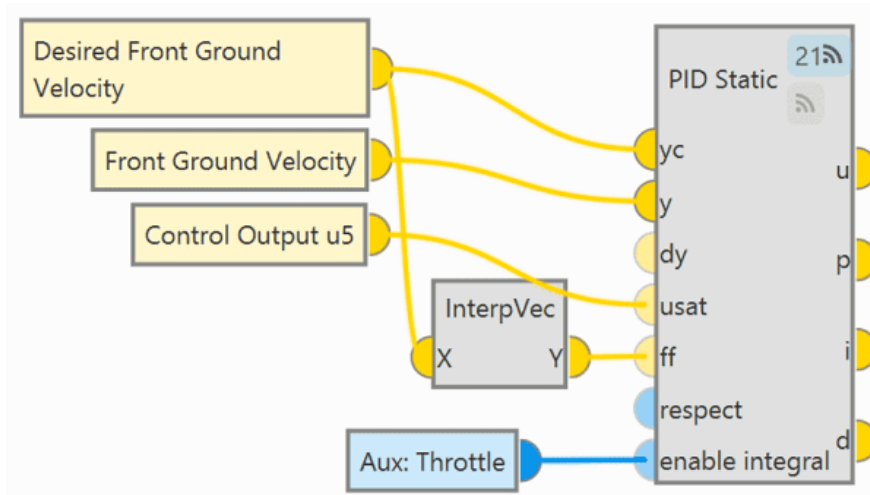

3. The input variable to the **Mixer** block is different in the Cruise and Hold flight phases:

- **Cruise**

In this flight phase, the input to the **Mixer** block is simply the variable Control mix written by the [Control Mix program](#).

Important

This also applies to all other flight phases that are not explicitly defined, as this is the "Default case".

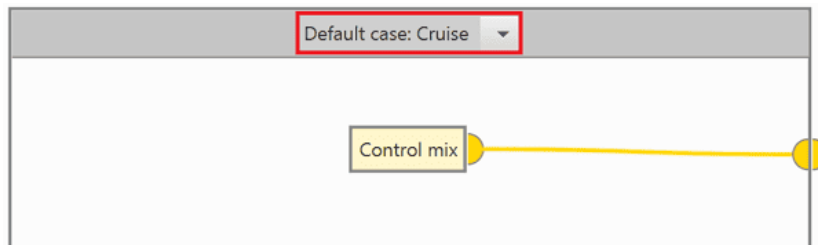

- **Hold**

In this flight phase, if the Stick-Transition variable has a value **less than 0.5** ⇒ Input for Mixer block = **0.0**.

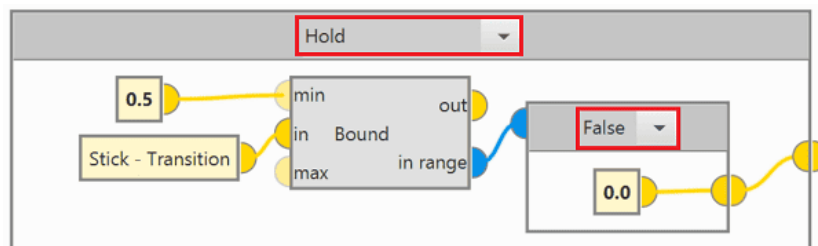

Otherwise, if the Stick-Transition variable has a value **greater than 0.5** ⇒ Input for Mixer block = **1.0**.

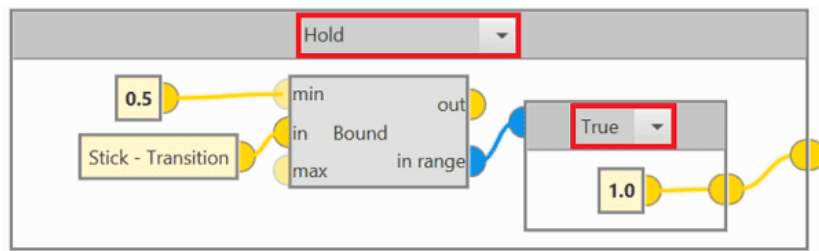

Note

This control logic represents the limits of the Control mix variable, being **0** quadcopter configuration and **1** FW configuration.

Euler to Body Axis

The following program defines the transformation between **Euler** axis and **Body** axis.

The control variables Desired Roll rate, Desired Pitch rate and Desired Yaw rate are expressed in Euler axis, so to transform these variables into control outputs, it is necessary to transform them to the aircraft axis (Body axis).

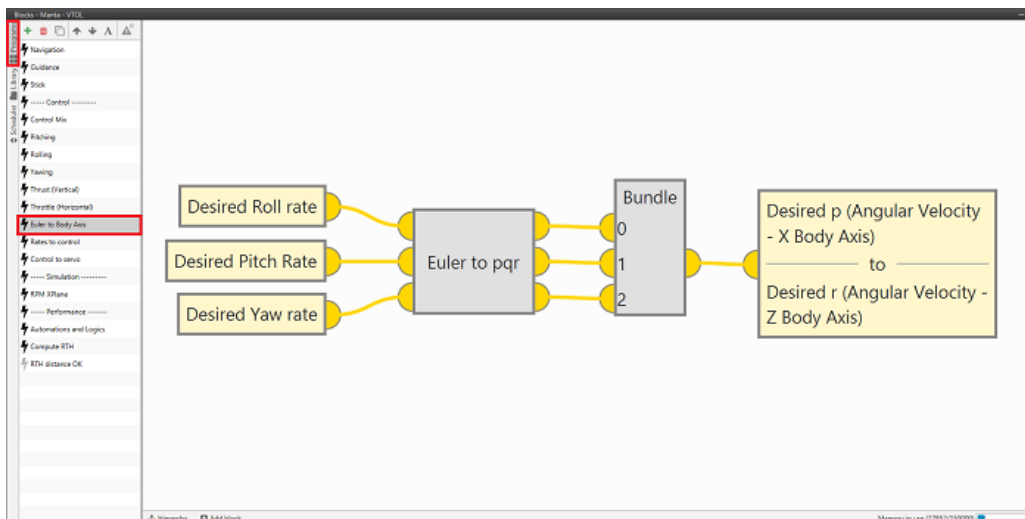

Euler to Body Axis - Program

For this purpose, a **custom block, Euler to pqr** block, has been created in the **Library blocks**. In this block, the mathematical relationships necessary to achieve this transformation have been defined.

Euler To Pqr Block - Explanation

The algorithm of this block and the mathematical relationships it implements are shown below:

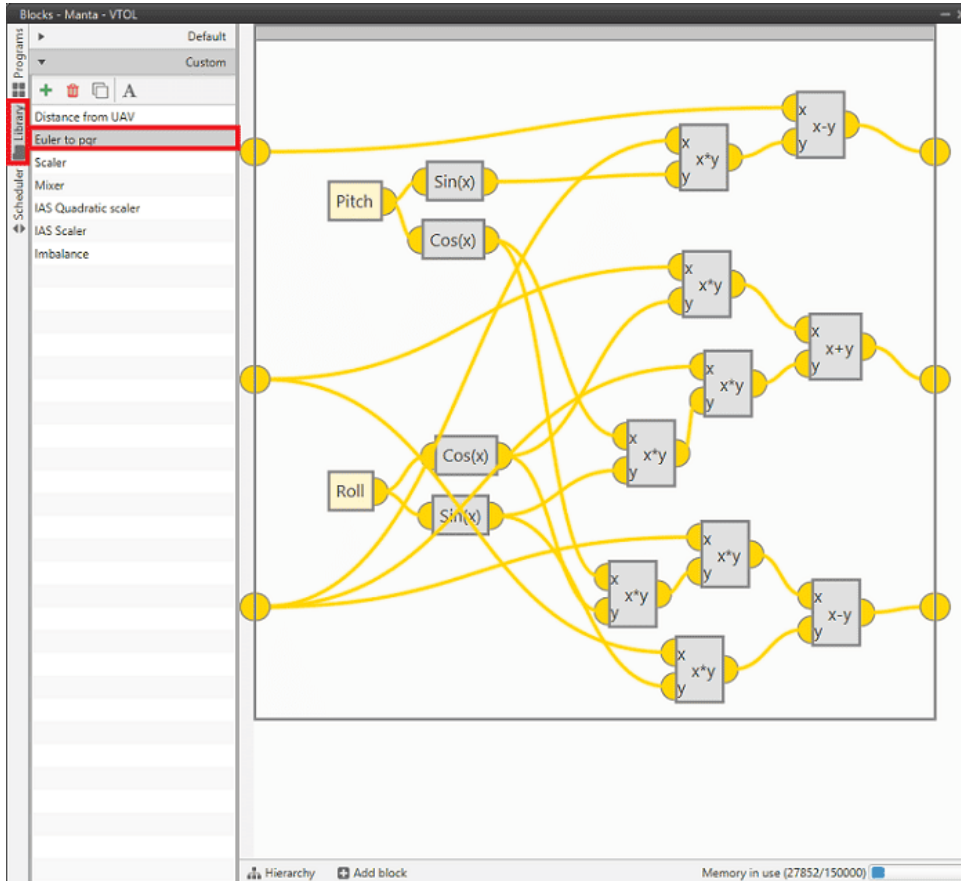

Euler to pqr block

The transformation between axes that is performed is as follows:

$$\begin{bmatrix} P \\ Q \\ R \end{bmatrix} = \begin{bmatrix} 1 & 0 & -\sin(\theta) \\ 0 & \cos(\phi) & \sin(\phi)\cos(\theta) \\ 0 & -\sin(\phi) & \cos(\phi)\cos(\theta) \end{bmatrix} \begin{bmatrix} \dot{\phi} \\ \dot{\theta} \\ \dot{\psi} \end{bmatrix}$$

For more information on custom blocks, visit the [Library blocks - Block Programs](#) section of the **1x PDI Builder** user manual.

Rates to control

The following program is defined to control the value of the **control outputs** to perform the desired action defined by the **Guidance** and **Navigation** program variables.



Rates to control - Program

For the definition of this program, it is first necessary to create the following **custom blocks** in the **Library blocks**. For more information on custom blocks, visit the [Library blocks - Block Programs](#) section of the **1x PDI Builder** user manual.

Ias Scaler Block - Explanation

IAS Scaler allows to **scale linearly** an input variable with the indicated airspeed.

This block implements the following formula:

$$u = \frac{v_i}{\max(v, v_i)} \cdot x$$

Where,

- u : output
- v_i : nominal speed, in this case 16 m/s
- v : actual measured speed, in this case Indicated Airspeed (IAS)
- x : input

Therefore, it would be:

$$u = \frac{16}{\max(IAS, 16)} \cdot x$$

Note that this formula has a lower saturation value of 16 m/s, so the **scaling** in this case is done for **speeds higher than the nominal**.

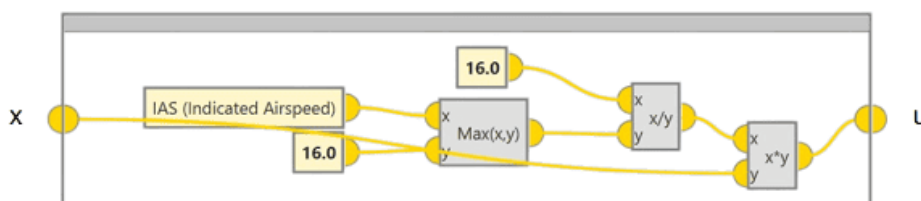

Ias Quadratic Scaler Block - Explanation

IAS Quadratic Scaler allows **quadratic scaling** two input variables with the indicated airspeed.

This block implements the following formulas:

$$u_1 = \left(\frac{v_i}{\max(v, v_i)} \right)^2 \cdot x_1$$

$$u_2 = \left(\frac{v_i}{\max(v, v_i)} \right)^2 \cdot x_2$$

Where,

- u_1 : output variable 1
- u_2 : output variable 2
- v_i : nominal speed, in this case 16 m/s
- v : actual measured speed, in this case Indicated Airspeed (IAS)
- x_1 : input variable 1
- x_2 : input variable 2

Therefore, it would be:

$$u_1 = \left(\frac{16}{\max(IAS, 16)} \right)^2 \cdot x_1$$

$$u_2 = \left(\frac{16}{\max(IAS, 16)} \right)^2 \cdot x_2$$

Note that this formula has a lower saturation value of 16 m/s, so the **scaling** in this case is done for **speeds higher than the nominal**.

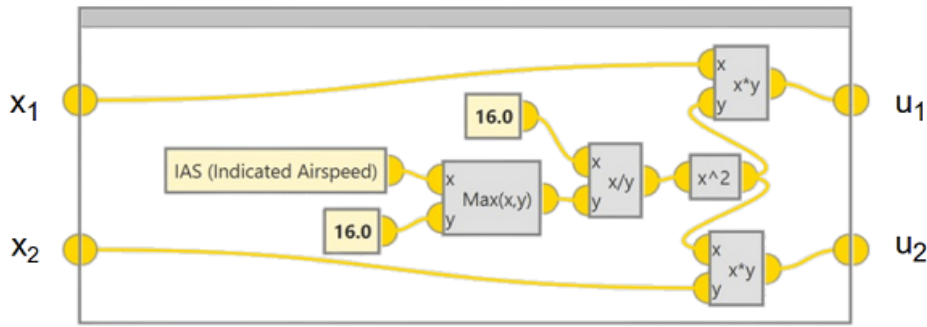

Imbalance Block - Explanation

This **Imbalance** block is used to determine whether a variable remains constant over time. This is achieved by checking that the rate of change of the evaluated variable is as close as possible to **0.0**.

To do this, the input variable is evaluated with the **Bound** block where the output in range is set to **true** if the value of the variable is **less than 0.1**.

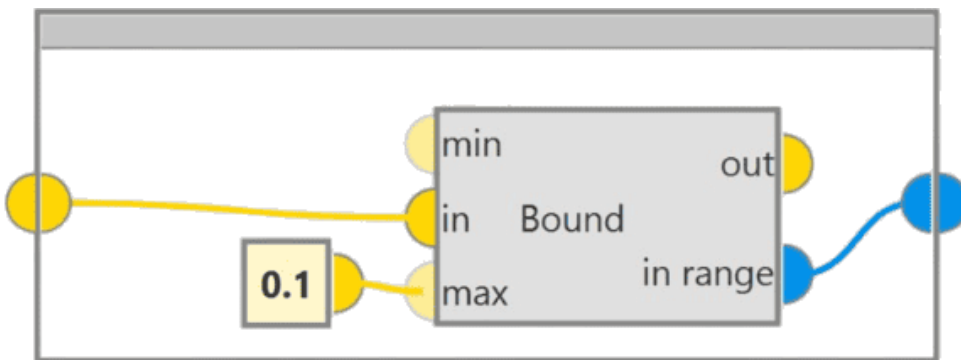

Once the custom blocks have been created, in this program the different control outputs are defined for each of the control actions in quadcopter or FW configuration:

- **Pitch quadcopter - u0**

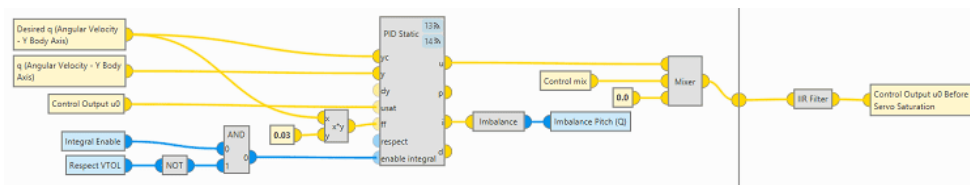

- **PID** controller allows to calculate the output response to reach the Desired q (Angular Velocity - Y Body Axis) variable.

- **Mixer** block provides the output signal from the PID controller to the **quadcopter** flight configuration rate.
- **IIR Filter block** adapts the signal with a low pass filter. In this way, the aircraft is able to perform a controlled actuation.

Note

This control logic allows Autopilot 1x to compare the variable **q (Angular Velocity - Y Body Axis)**, obtained in the **Navigation** program, and the **Desired q (Angular Velocity - Y Body Axis)** variable, obtained in the **Guidance** program, and determine the response that the aircraft must have to reach the desired variable. To achieve this desired value, the **Control Output u0** variable is determined, which defines the position of the actuators/servos for **pitching** in **quadcopter** flight configuration.

• Roll quadcopter - u2

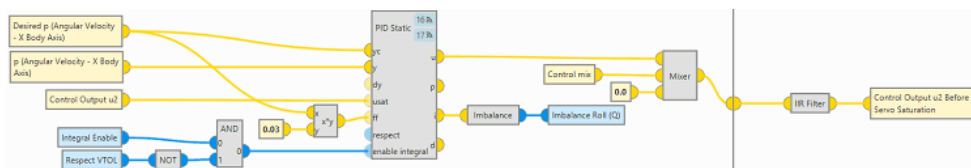

- **PID** controller allows to calculate the output response to reach the Desired p (Angular Velocity - X Body Axis) variable.
- **Mixer** block provides the output signal from the PID controller to the **quadcopter** flight configuration rate.
- **IIR Filter block** adapts the signal with a low pass filter. In this way, the aircraft is able to perform a controlled actuation.

Note

This control logic allows Autopilot 1x to compare the variable **p (Angular Velocity - X Body Axis)**, obtained in the **Navigation** program, and the **Desired p (Angular Velocity - X Body Axis)** variable, obtained in the **Guidance** program, and determine the response that the aircraft must have to reach the desired variable. To achieve this desired value, the **Control Output u2** variable is determined, which defines the position of the actuators/servos for **rolling** in **quadcopter** flight configuration.

• **Yaw quadcopter - u3**

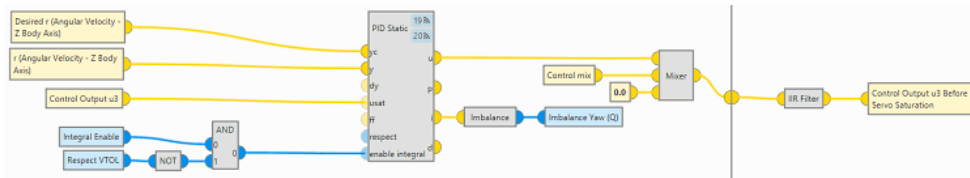

- **PID** controller allows to calculate the output response to reach the Desired r (Angular Velocity - Z Body Axis) variable.
- **Mixer** block provides the output signal from the PID controller to the **quadcopter** flight configuration rate.
- **IIR Filter block** adapts the signal with a low pass filter. In this way, the aircraft is able to perform a controlled actuation.

Note

This control logic allows Autopilot 1x to compare the variable **r (Angular Velocity - Z Body Axis)**, obtained in the **Navigation** program, and the **Desired r (Angular Velocity - Z Body Axis)** variable, obtained in the **Guidance** program, and determine the response that the aircraft must have to reach the desired variable. To achieve this desired value, the **Control Output u3** variable is determined, which defines the position of the actuators/servos for **yawing** in **quadcopter** flight configuration.

• **Pitch FW - u4**

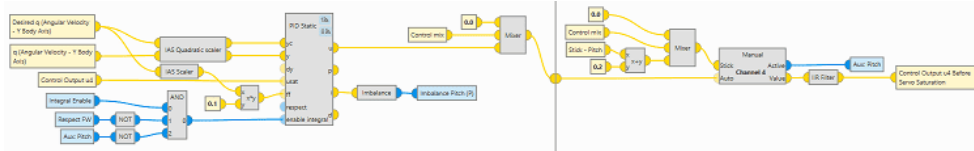

- **IAS Quadratic scaler** block
- **IAS Scaler** block
- **PID** controller providing the desired change variable to **Pitch** in **FW** flight configuration.
- **Mixer** block provides the output signal from the PID controller to the **FW** flight configuration rate.
- **Manual** block changes the output value depending on the control mode.
- **IIR Filter** block adapts the signal with a low pass filter. In this way, the aircraft is able to perform a controlled actuation.
- **InterpVec** block applies the configured table interpolation on each of the components of the input vector.

Note

This control logic allows Autopilot 1x to compare the variable **q (Angular Velocity - Y Body Axis)**, obtained in the **Navigation** program, and the **Desired q (Angular Velocity - Y Body Axis)** variable, obtained in the **Guidance** program, and determine the response that the aircraft must have to reach the desired variable. To achieve this desired value, the **Control Output u4** variable is determined, which defines the position of the actuators/servos for **pitching** in **FW** flight configuration.

• **Roll FW - u6**

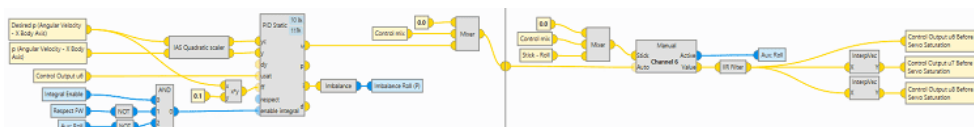

- **IAS Quadratic scaler** block
- **PID** controller providing the desired change variable to **Roll** in **FW** flight configuration.

- **Mixer** block provides the output signal from the PID controller to the **FW** flight configuration rate.
- **Manual block** changes the output value depending on the control mode.
- **IIR Filter block** adapts the signal with a low pass filter. In this way, the aircraft is able to perform a controlled actuation.
- **InterpVec block** applies the configured table interpolation on each of the components of the input vector.

Note

This control logic allows Autopilot 1x to compare the variable **p** (**Angular Velocity - X Body Axis**), obtained in the **Navigation** program, and the **Desired p (Angular Velocity - X Body Axis)** variable, obtained in the **Guidance** program, and determine the response that the aircraft must have to reach the desired variable. To achieve this desired value, the **Control Output u6** variable is determined, which defines the position of the actuators/servos for **rolling** in **FW** flight configuration.

Control to servo

The following program allows the user to configure the transformation between the action and the servo value. To do this, the **Actuator** block and the different inputs and outputs must be configured.

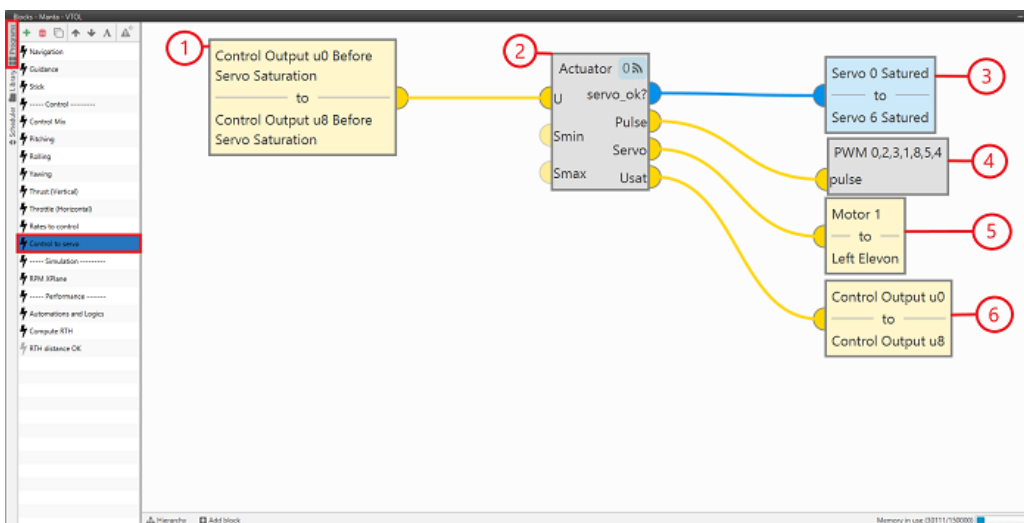

Control to servo - Program

In this program it is necessary to define and configure the following blocks:

1. A [Read multiple Reals block](#) with the variables that define the actions commanded by the control programs.

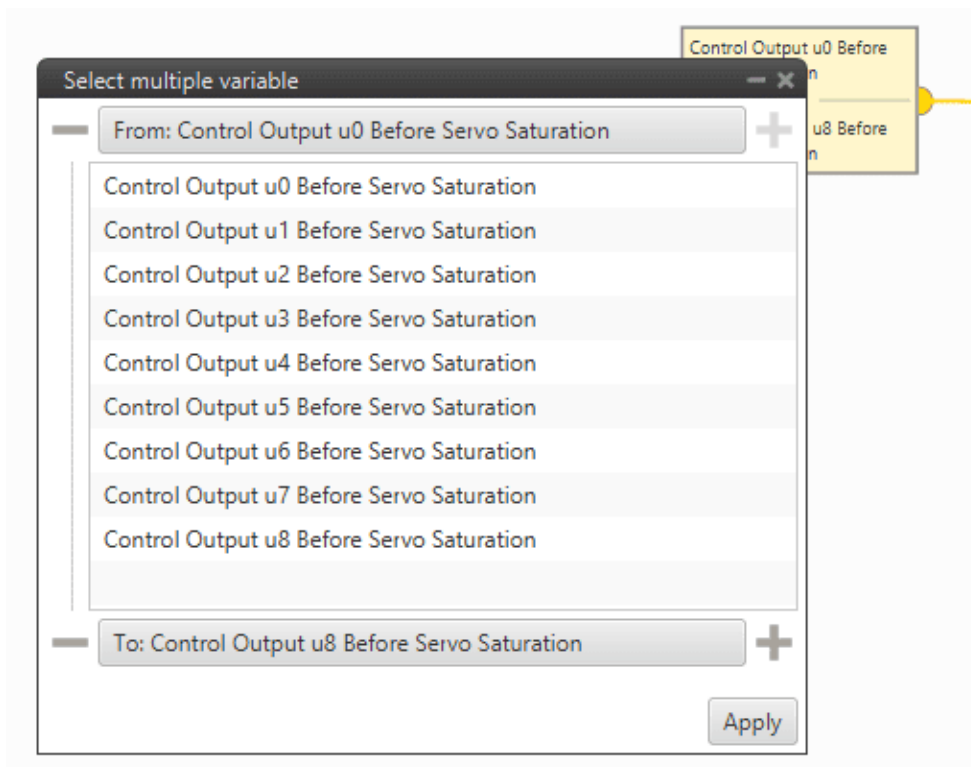

2. [Actuator block](#) that transforms input variables into servo values.

Important

The configuration of the **Actuator** block is defined in the [Actuators - Actuators & SU Matrix](#) section of this manual.

3. A [Write multiple Bits block](#) with the servo bits that had to be trimmed to prevent saturation.

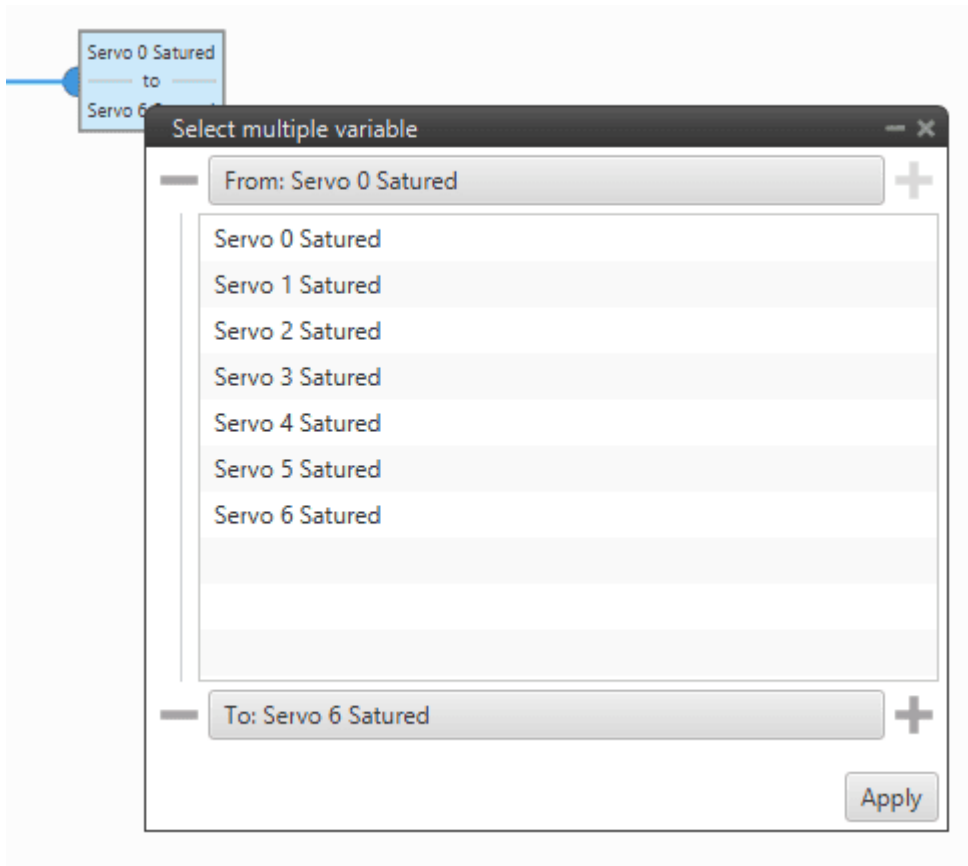

4. A **PWM block** to indicate the PWM variables to which the PWM pulse should be transmitted for each servo.

Note

The pins to which the servos are connected must match those previously changed from GPIO to PWM.

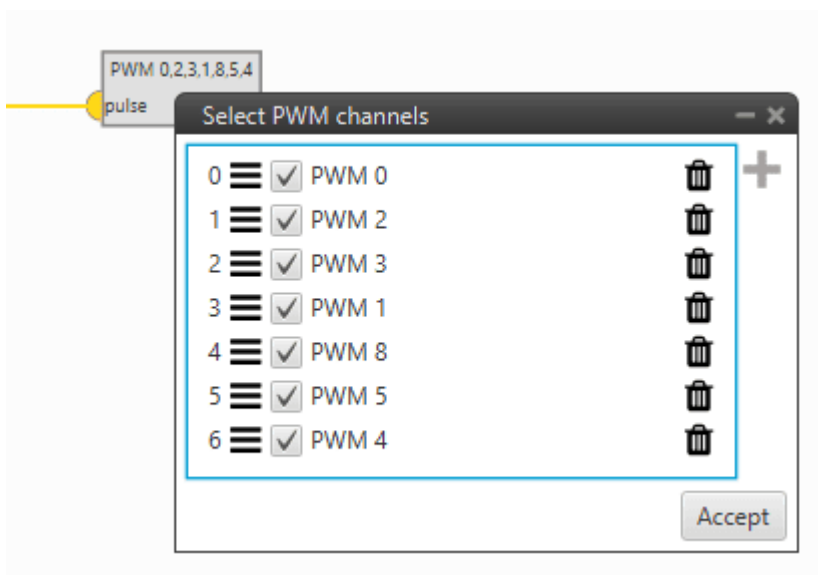

5. A **Write multiple Reals block** that writes the servo value that generates the actuator motion to the servo variables.

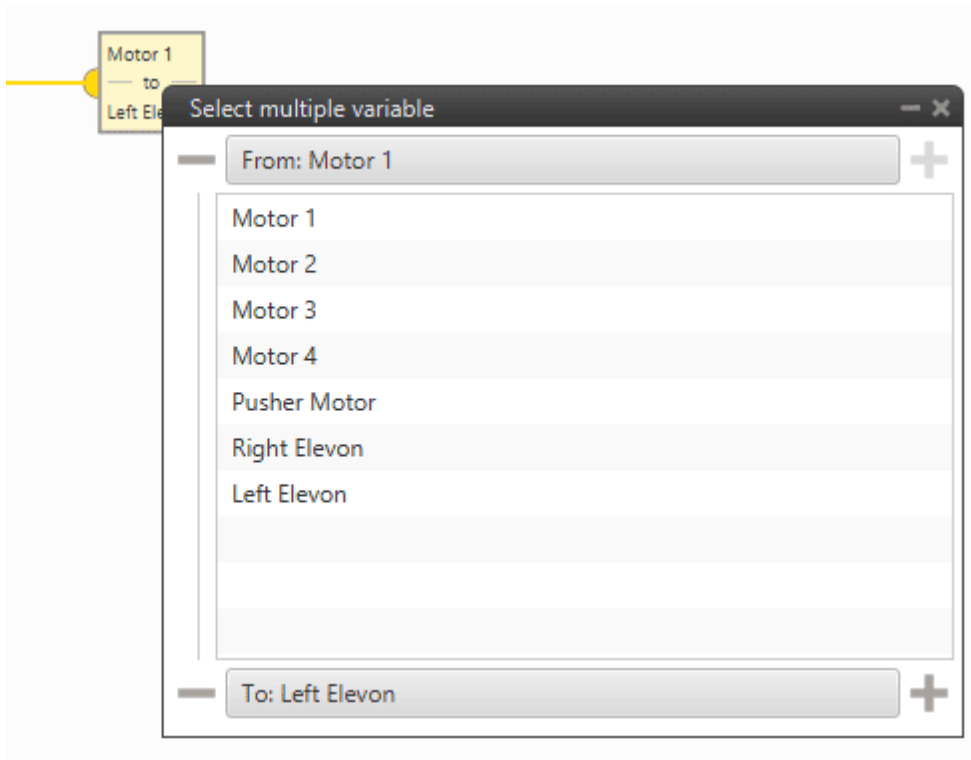

6. A **Write multiple Reals block** with the variables for Control actions after servo saturation.

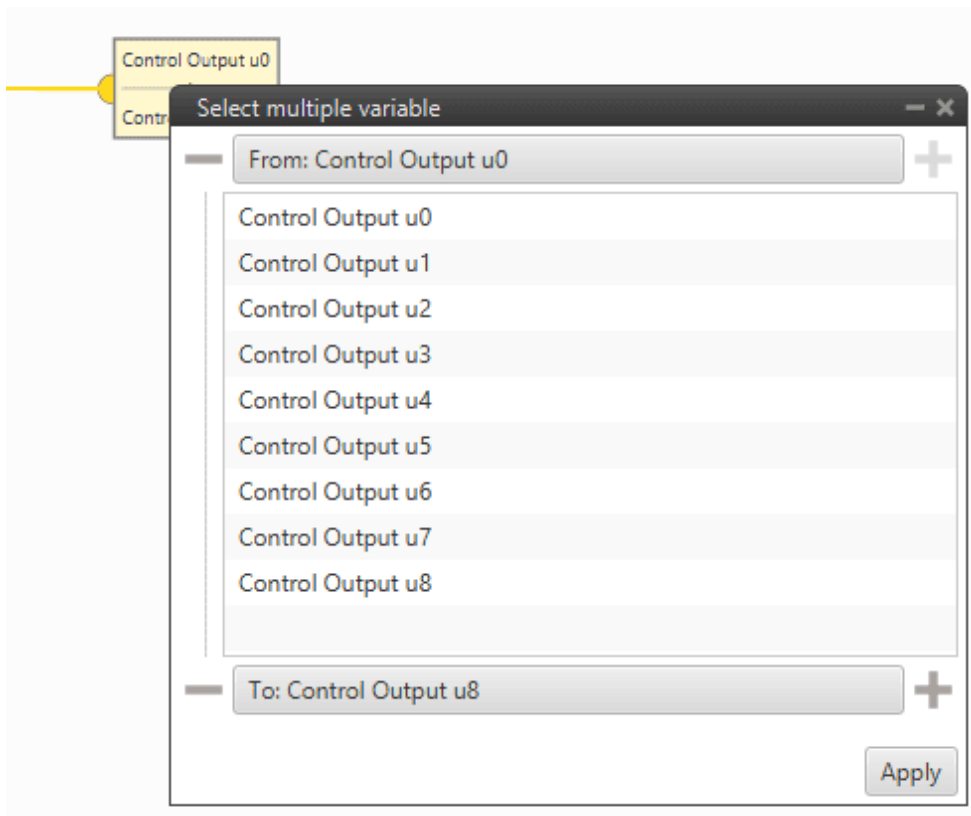

RPM XPlane

The following program is defined to adapt the performance of the aircraft in real flight to a simulation environment with X-Plane11 software.

This allows to use the same 1x air configuration without having to make 2 different ones for the "phase" of creating and validating the configuration and the real operation.

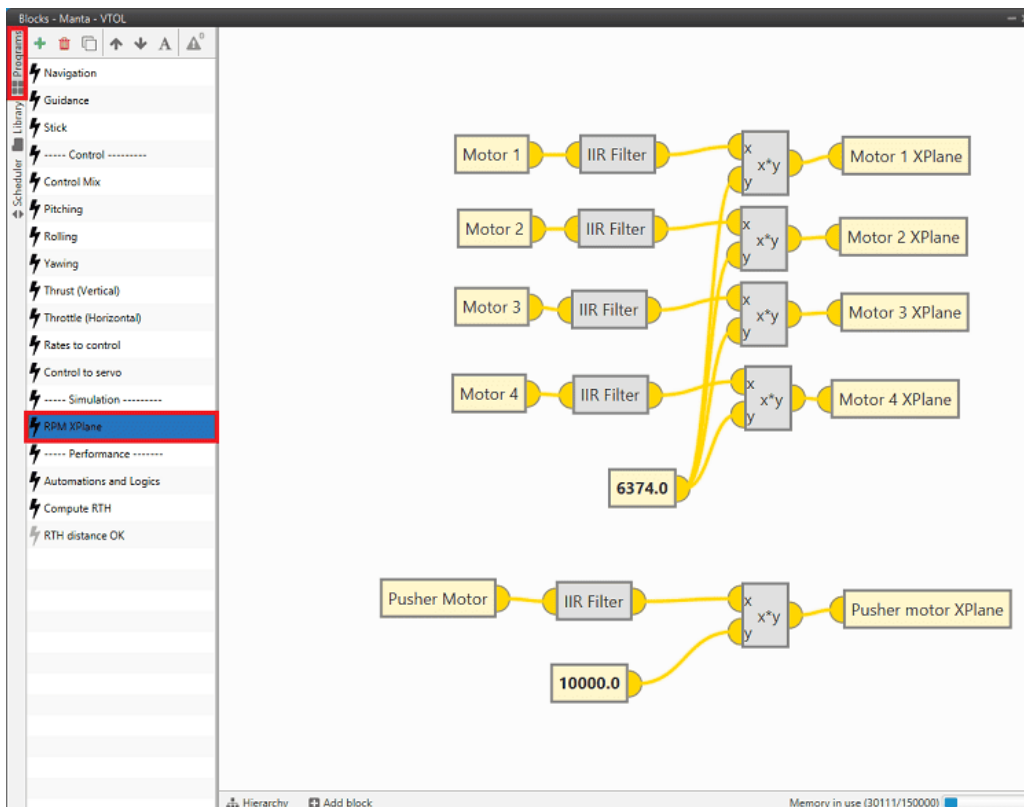

RPM XPlane - Program

For this purpose, the **IIR Filter block** is used. This block is a low pass filter that allows the motor RPM of the motor to be raised in a controlled way.

Motor X variables have a value from **0 to 1** and are multiplied by the **maximum RPM** of the motor. The result of this multiplication will be the value used in the simulation.

Compute RTH

The following program is defined to set which **Home point** the Autopilot 1x will use when the Return to Home (RTH) phase is executed.

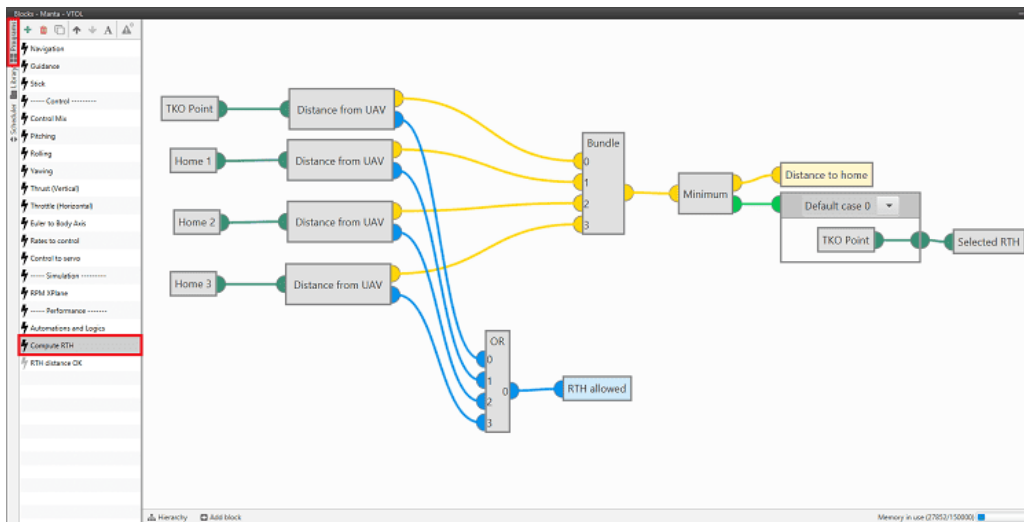

Compute RTH - Program

The program is defined as follows:

The distance between the UAV and each of the predefined points (TKO Point, Home 1, Home 2, Home 3) is calculated using the **Distance from UAV** block. This is a **custom** block created in the **Library blocks**.

Distance From Uav Block - Explanation

This block follows the following structure:

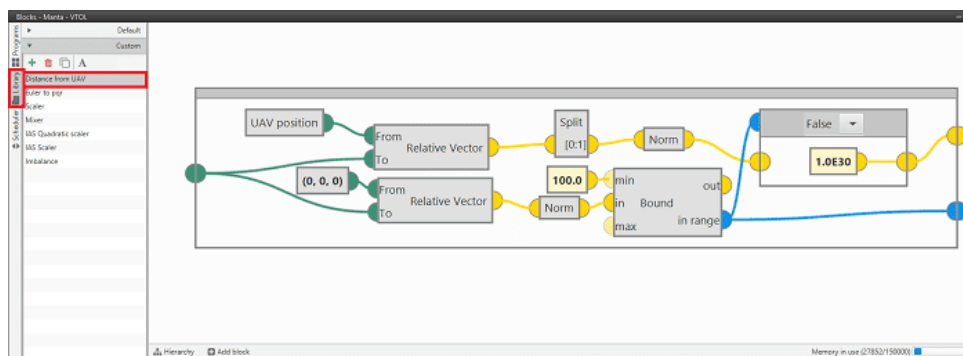

The distance **from the UAV position to the predefined point** and the distance **from the NED origin to the predefined point** are calculated. These distances are calculated using the **Relative Vector** block, which returns a relative vector in NED frame from the two input positions. For more information on this block, visit the [Positions blocks - Block Programs](#) section of the **1x PDI Builder** user manual.

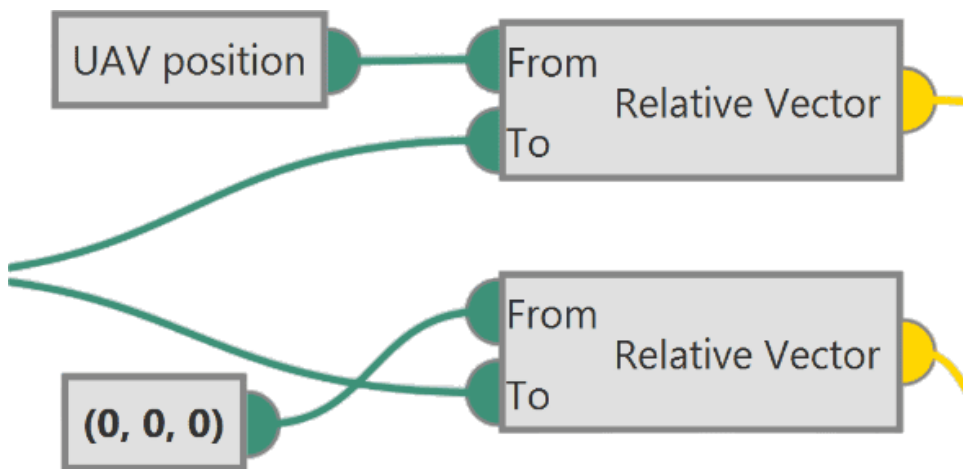

Distance from (0, 0, 0) to Home

- Once this distance has been calculated, the [Relative Vector block](#) returns a vector of three components (North, East, Down).
- Then, the [Norm block](#) returns the norm of this vector and the [Bound block](#) evaluates if this value is within the defined limits (**100 m minimum**). The reason for defining this minimum is because if no Home point has been predefined, Autopilot 1x will take as point the origin **(0, 0, 0)**. Thus, to avoid guidance errors when flying around the origin, this minimum distance is defined.

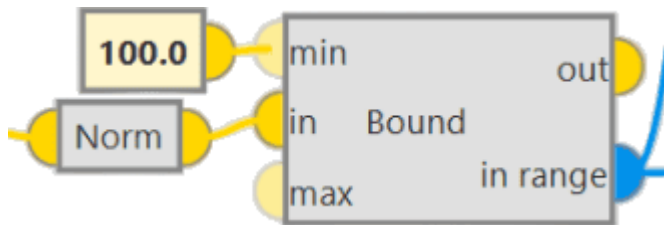

Distance from UAV position to Home

- Once this distance has been calculated, the [Relative Vector block](#) returns a vector of three components (North, East, Down).
- The first 2 components of this vector should be used in the program to determine the distance between the two points. To do this, the [Split block](#) is used to create a vector with the first two variables and then, the [Norm block](#) returns the norm of this vector.
- This value will only be taken as valid if the **distance to the origin is greater than 100 m**, so the [Bound block](#) will return the bit as **true**. Otherwise, if the bit is **false**, i.e., the distance is **less than 100 m**, a distance large enough for this point to be discarded as a valid point is defined.

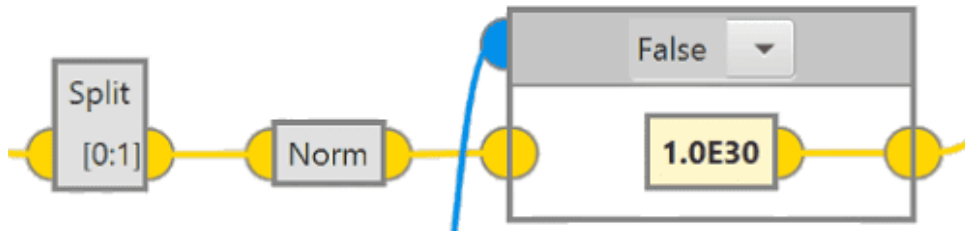

For more information on custom blocks, visit the [Library blocks - Block Programs](#) section of the **1x PDI Builder** user manual.

After evaluating the distance between the defined points and the UAV, the bit RTH allowed will be **true** if one or more of them can be taken as a **valid point**. In case **no valid point** is found, this bit will be **false** and it will **not** be possible to transition to the **RTH phase**.

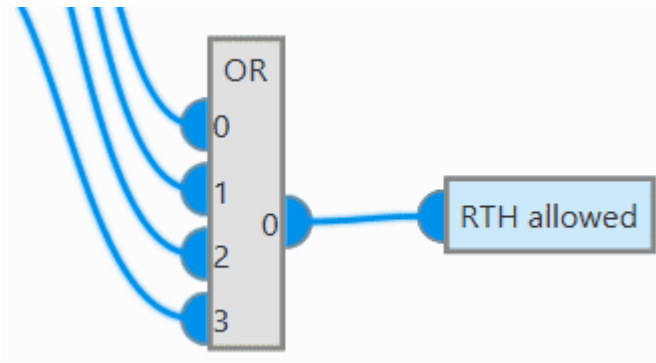

Finally, among all the valid Home points, the one to which the UAV has less distance is chosen and selected as the point to use in the RTH phase.

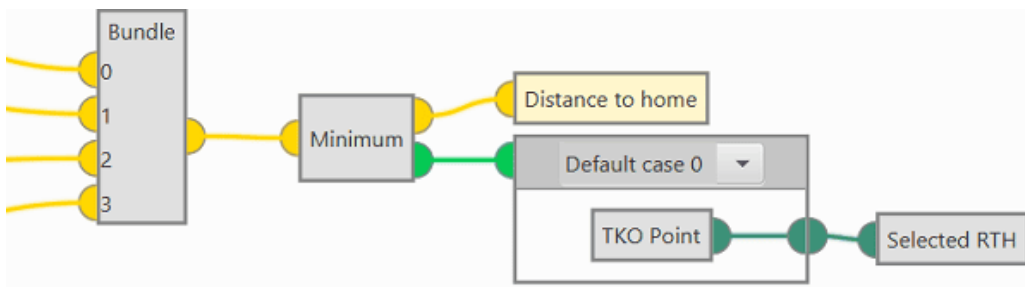

RTH distance OK

The following program is defined to determine whether the **Home point** to be used in the **RTH phase** selected in the previous program, [Compute RTH](#), is valid or not.

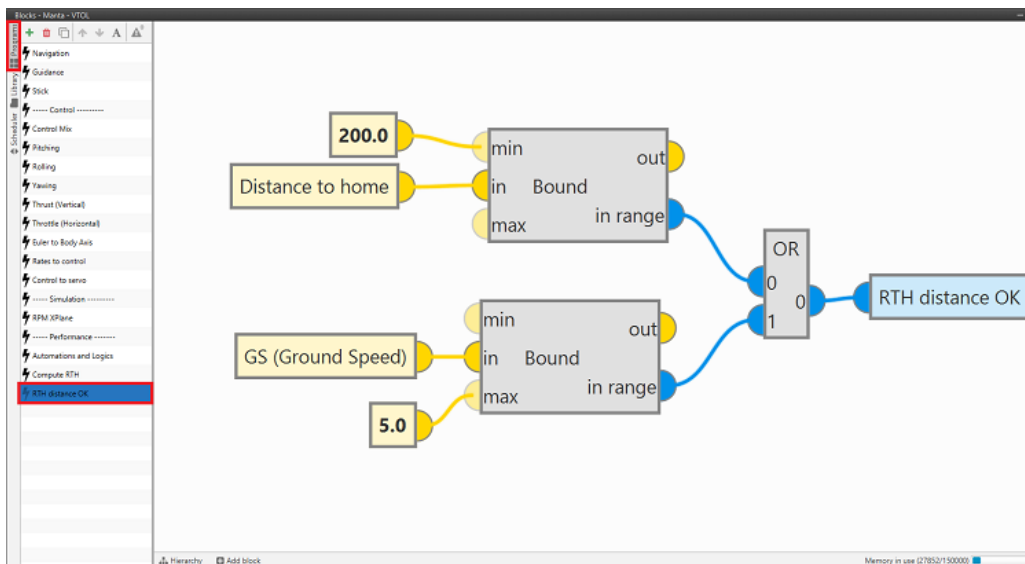

RTH distance OK - Program

For this purpose, the program defines two conditions that determine the validity of the **Home point** selected:

- **Distance to home**

A **minimum distance** of **200 meters** is set at which the **Home point** has to be from the **UAV**. If the value of the Distance to home variable is within the defined range, the **Bound block** returns a **true** bit.

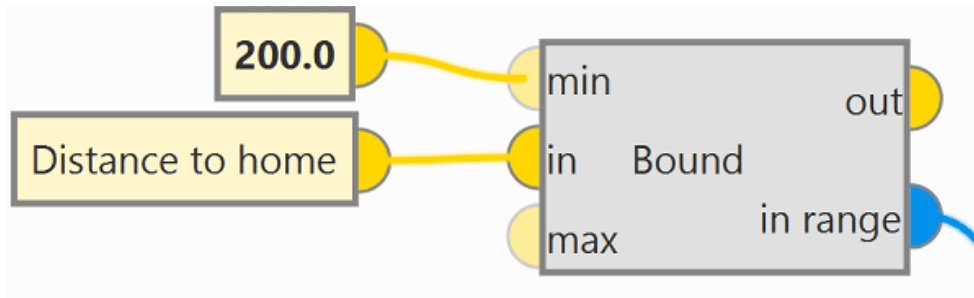

- **GS (Ground Speed)**

A **maximum GS** of **5.0 m/s** is defined. If this speed is within the defined range, the **Bound block** returns a **true** bit.

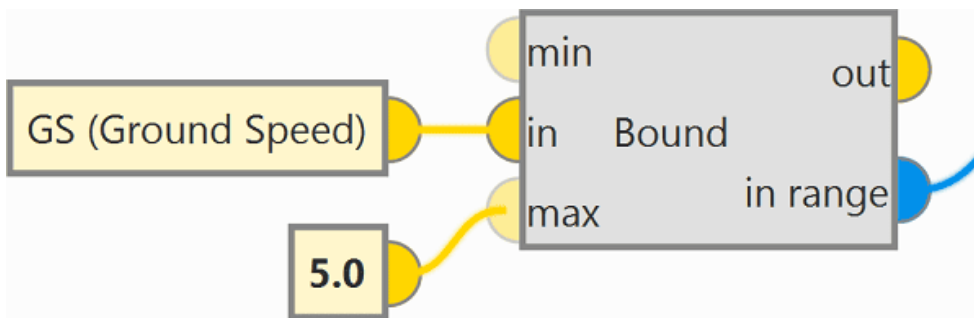

If **one** of these two conditions is met, the **Home point** is taken as **valid** and Autopilot 1x will guide to this point. Otherwise, if neither of the two conditions is met, the **Loiter in RTH** automation will cause the aircraft to perform a **Loiter** until one of those two conditions is met.

These conditions allow the aircraft to perform a **controlled transition**, having enough distance and time to perform it safely.

Automations

Automations are actions that are carried out when a combination of events happens, i.e., when the events are accomplished the action is done. For more information on automations, visit the **Automations** section of the **1x PDI Builder** user manual.

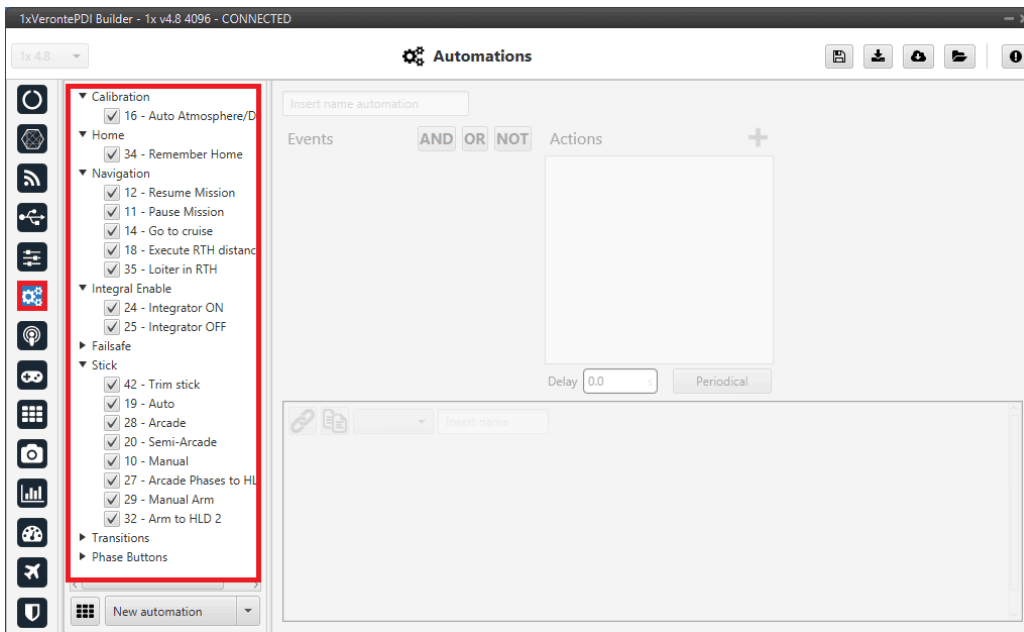

VTOL Automations

The different events, actions and automations that have been created for the operation of the Embention VTOL aircraft are shown below.

Warning

The user can create as many automations as desired up to a maximum of **500 events, 120 actions** and **100 automations**.

The automations have been divided into groups depending on the functionality for which they have been created:

Automations

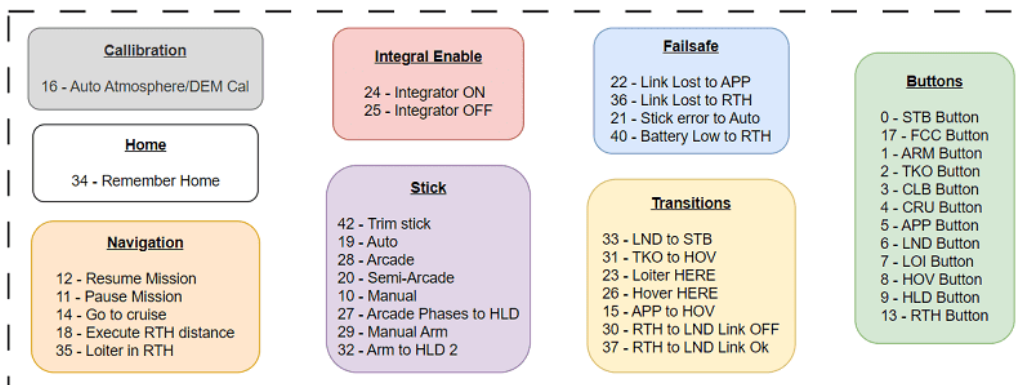

Calibration

16 - Auto Atmosphere/DEM Cal

This automation establishes the events that must be triggered for the autopilot to perform an atmospheric calibration. For this, the autopilot position must be fixed, with a GNSS accuracy of less than 2 meters, and be in the STB or INI phase.

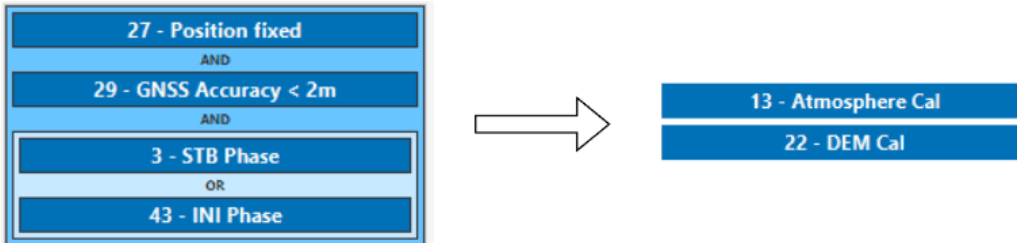

Home

34 - Remember Home

This automation remembers the take-off point. In the RTH phase, the autopilot guides the aircraft to the nearest Home point, so if no other point has been established in the mission, the autopilot will automatically establish a path to guide the aircraft back to the take-off point.

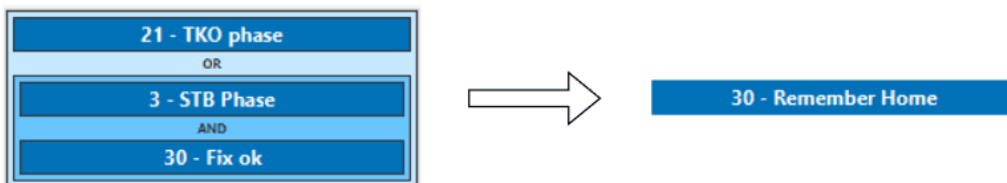

Navigation

- **18 - Execute RTH distance**

When the autopilot is in RTH phase, it executes the program [RTH distance ok](#) which calculates the distance to the nearest Home point.

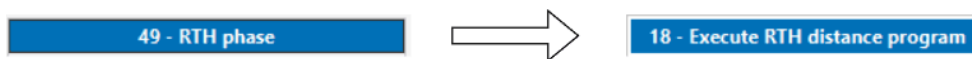

- **35 - Loiter in RTH**

This automation allows the aircraft to perform a Loiter when it is in RTH phase and does not meet the conditions to take the RTH point as correct.



Integral Enable

The following automations set the value of the **Integral Enable** bit, which is used as the value for the enable integral input of the **PID controllers** used in [Rates to control program](#).

- **24 - Integrator ON**



When **Integral ON** is triggered, a value of **1** is stored in the Integral Enable bit, turning **true**. Therefore, the enable integral input of the PDI controller is true, which means that the PDI works as usual.

- **25 - Integrator OFF**

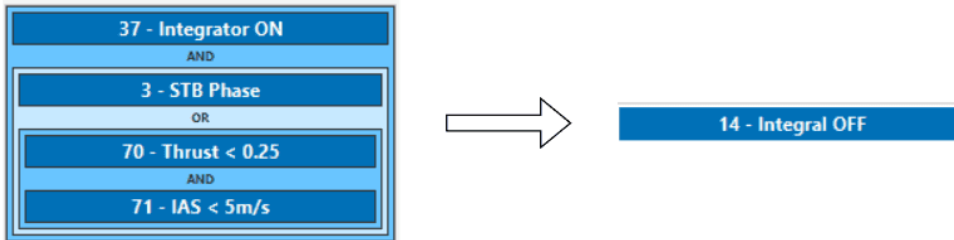

When **Integral OFF** is triggered, a value of **0** is stored in the Integral Enable bit, turning **false**. Therefore, the enable integral input of the PDI controller is false, which implies that the integral term is exponentially discharged.

Failsafe

The following automations are defined to ensure the performance of the aircraft by activating predetermined actions in case of **failure**. For example, in case of stick error, stick connection error or in case of low battery.

- **22 - Link Lost to APP**

When the aircraft is in one of the flight phases (Loiter, Hover, Hold, Cruise, Climb, Approach, Return Home or Take-off), with a control mix value **greater than 0.9** and loses radio connection for 2 seconds, it automatically switches to the Approach (APP) phase.

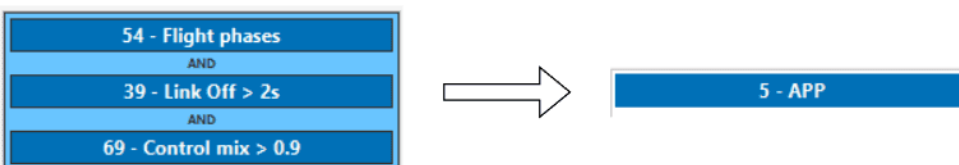

• **36 - Link Lost to RTH**

When the aircraft is in one of the flight phases (Loiter, Hover, Hold, Cruise, Climb, Approach, Return Home or Take-off), with a control mix value **less than 0.9** and loses radio connection for 2 seconds, it automatically switches to the RTH phase.

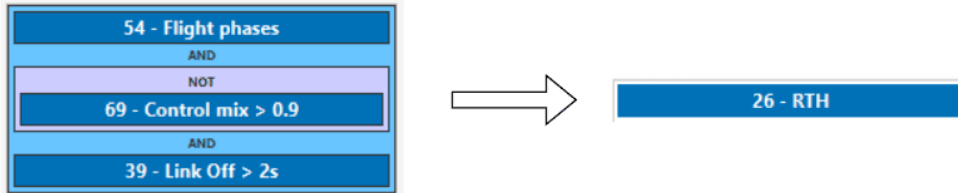

• **21 - Stick error to Auto**

The autopilot switches to auto mode when Stick error bit is false.



• **40 - Battery Low to RTH**

When the battery drops below a certain value, in this case 21.7 V, and the aircraft is in one of the flight phases (Loiter, Hover, Hold, Cruise, Climb, Approach, Return Home or Take-off), the autopilot will automatically guide the aircraft to RTH phase.



Stick

The following automations change the flight mode depending on the stick position, for this the Stick-mode and Stick-Manual variables are used.

Note

- Stick-mode: 3 positions (0; 0.5; 1)
- Stick-manual: 2 positions (0; 1)

• **42 - Trim stick**

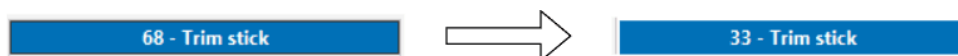

• **19 - Auto**

The autopilot switches to Auto mode when the Stick-mode variable has a value of **0** and the Stick-manual variable has a value of **0**.

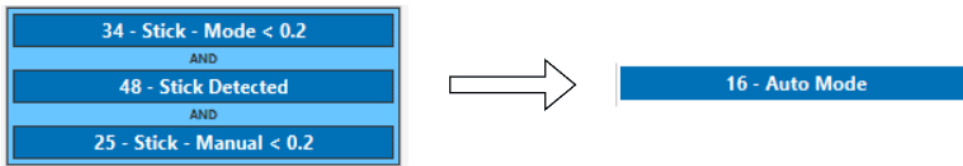

• **28 - Arcade**

The autopilot switches to Arcade mode when the Stick-mode variable has a value of **0.5** and the Stick-manual variable has a value of **0**.

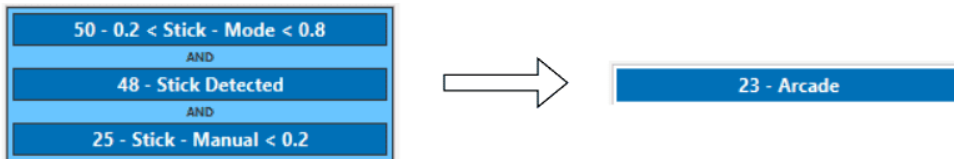

• **20 - Semi-Arcade**

The autopilot switches to Semi-Arcade mode when the Stick-mode variable has a value of **1** and the Stick-manual variable has a value of **0**.

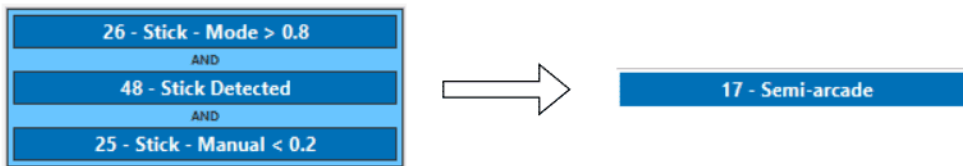

• **10 - Manual**

The autopilot switches to Manual mode when the Stick-manual variable has a value of **1**.



Transitions

• **33 - LND to STB**

This automation is complex due to the number of events that must be triggered for the aircraft to automatically transition from the Landing phase to the Standby phase:

- The aircraft must be on the ground, which means that the **Down Speed is zero** (event 57) as well as have a speed with respect to the ground that allows it to stop safely (event 77).
- While in Landing phase, the **Desired Down Speed** (DDown Speed) must have a value **greater than 0** (event 56).

- The aircraft must be in **quadcopter flight configuration** (event 47).
- The aircraft must be in the Landing phase or in the Hold or Hover phases, in arcade mode and with a value of 0 in the Stick-throttle command.

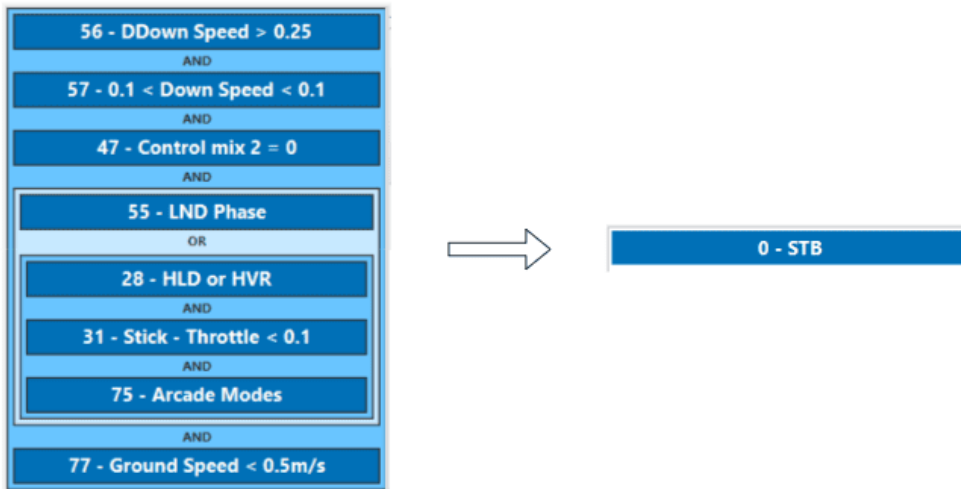

• **31 - TKO to HOV**

The following automation indicates the height above ground level at which the aircraft passes from Take-off to the Hover phase.

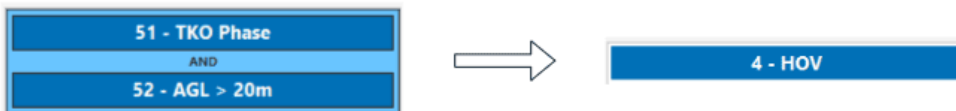

• **23 - Loiter HERE**

With this automation, the aircraft performs a Loiter around the point where it transitions to the Loiter phase.



• **26 - Hover HERE**

The aircraft performs the Hover actuation at the point where it transitions to the Hover phase.

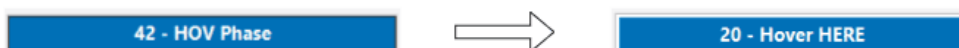

• **15 - APP to HOV**

In the Approach phase, if the airspeed is less than 7 m/s, the aircraft will move to the Hover phase at that point. This automation is used to perform a Hover over the defined Home point.



- **30 - RTH to LND Link Off**

If Hover is performed at the defined Home point and the connection is lost for 1 minute, Autopilot 1x transitions to the Landing phase.

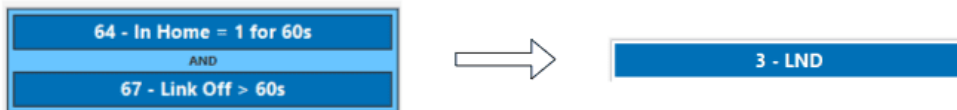

- **37 - RTH to LND Link Ok**

When the aircraft performs a Hover over the Home point for more than 20 seconds without losing connection, it automatically transitions to the Landing phase.

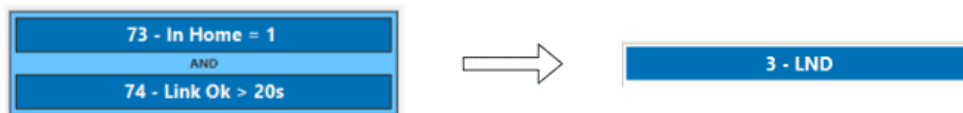

Phase Buttons

The following automations are defined for entering and transitioning between flight phases in [Veronte Ops](#). These actions are triggered by buttons that will appear in the **Veronte Panel**.

For some of these automations it will only be necessary to "slide" the button to trigger the flight phase change action, however, for others it will be necessary that some additional event is fulfilled to trigger the phase change.

Note

For more information on the possible flight phases, visit [Phases definition - Modes & Phases](#) section of this manual.

- **17 - FCC Button.**

To start the Flight Control Check (FCC) phase, in addition to pressing the FCC Button, Autopilot 1x must be in STB phase and the stick pilot must command the 1x.

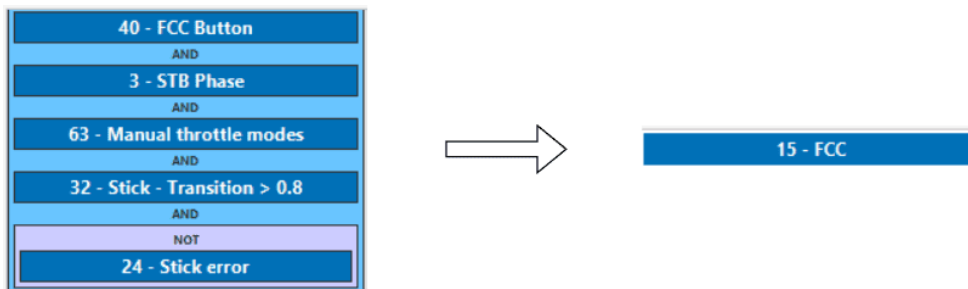

This flight phase is only performed in FW flight configuration, so the Stick - Transition variable that defines the configuration in which the aircraft flies must be greater than 0.8. This is because this variable is 0 when the configuration is quadcopter and 1 when the configuration is FW.

- **1 - ARM Button.**

To switch to Armed (ARM) phase, the ARM Button must be pressed, the autopilot must be in STB phase and the Down speed must be around 0.

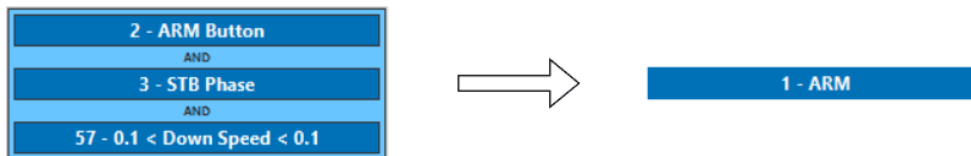

- **13 - RTH Button.**

To switch to RTH phase, the RTH Button must be pressed, RTH allowed bit must be true (when the autopilot can guide the platform to a defined Home point) and the autopilot must be in one of the flight phases that allows it to switch to RTH (HOV, APP, LOI, CRUISE, HLD).

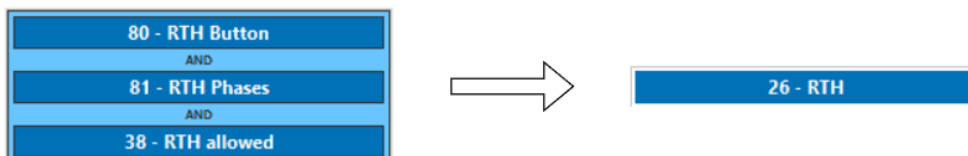

Transitions table

The following table shows the different possibilities for a transition between two flight phases.

		Destination												
Phases		Init	Standby	Take-off	Approach	Landing	Loiter	Hover	Hold	Cruise	Climb	Armed	Return Home	Flight Control Check
Origin	Init													
	Standby													
	Take-off													
	Approach													
	Landing													
	Loiter													
	Hover													
	Hold													
	Cruise													
	Climb													
	Armed													
	Return Home													
	Flight Control Check													

Transitions Table

Sensors

The configuration of the different sensors used for autopilot navigation is explained below.

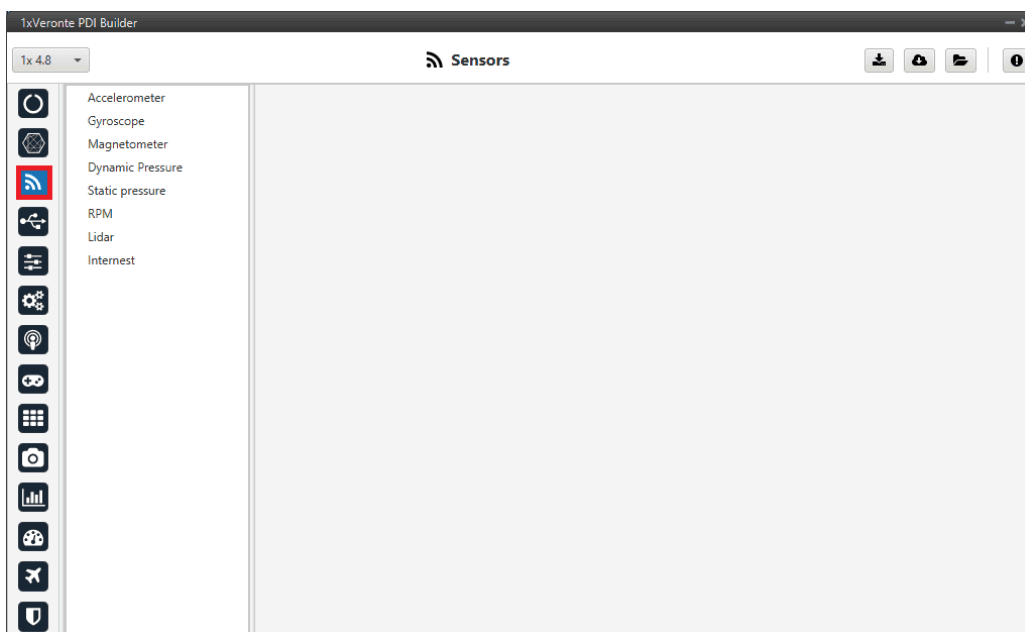

Sensors Panel

Veronte Autopilot 1x incorporates 3 Inertial Measurement Units (IMUs) that allow the 1x system to measure different variables and that are the main source of navigation data.

Accelerometer

Note

For a detailed explanation of the available accelerometer sensors, please visit the [Accelerometer - Sensors](#) section of the **1x PDI Builder** user manual.

The accelerometer from the IMU can be configured as explained in the panels shown below.

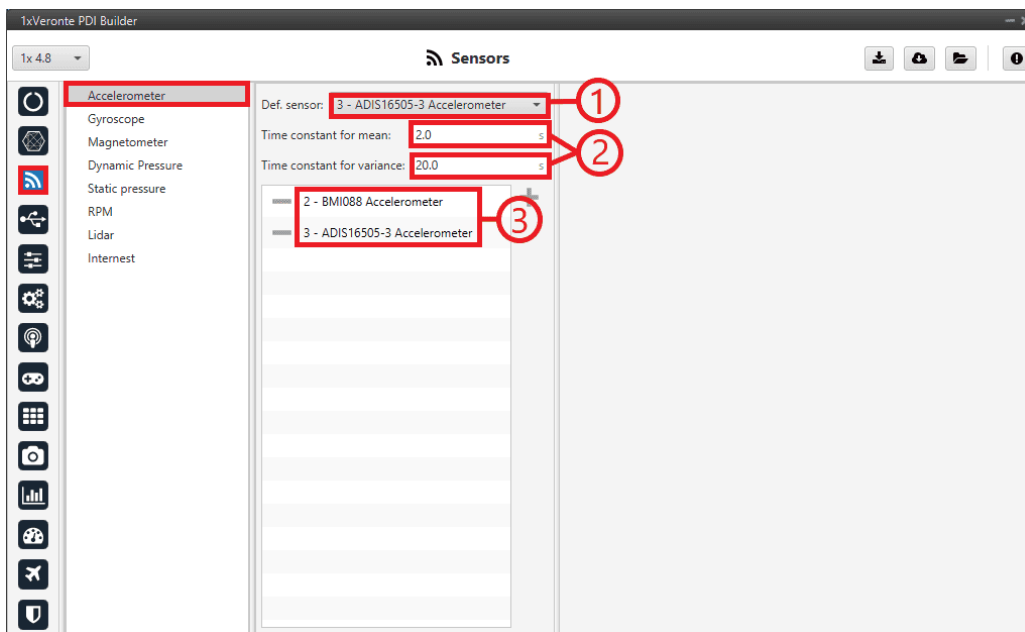

Accelerometer Panel

⚠ Important

It is recommended to select multiple of these sensors for the navigation algorithm, so that Veronte Autopilot 1x performs a combination of all the measurements of the selected accelerometers.

This combination consists of calculating the means and variances of each of these accelerometers in a given time (Time constant for mean and Time constant for variance) to obtain a weighted mean with the inverse of the variance. The lower the variance, the greater the weight of that sensor in the mean.

1. The ADIS16505-3 Accelerometer sensor has been chosen as the **default sensor**. If all other sensors fail, the measurement value will be that of the default sensor.
2. A time of 2 seconds has been defined for the **Time constant for mean**, and 20 seconds for the **Time constant for variance**.
3. The **BMI088** and **ADIS16505-3** accelerometers sensors have been selected and their configuration is described below.

Common configuration of BMI088 Accelerometer and ADIS16505-3 Accelerometer

The screenshot displays the 'Sensors' configuration window in the 1xVeronte PDI Builder. The 'Accelerometer' section is active, showing a list of selected sensors: '2 - BMI088 Accelerometer' and '3 - ADIS16505-3 Accelerometer'. The configuration panel on the right shows the following settings:

- Def. sensor:** 3 - ADIS16505-3 Accelerometer
- Time constant for mean:** 2.0 s
- Time constant for variance:** 20.0 s
- Initial variance:** 1.0
- Minimum variance:** 1.0E-4
- Range:** 24g
- Sampling frequency:** 1600 Hz
- Low pass frequency:** 280 Hz (245 Hz fo...)
- Notch filter:**
 - Mode:** Main frequency
 - Main Frequency:** Constant value: 22.5
 - Bandwidth:** 1.0 Hz
 - Notch gain:** 6.0206 dB
- Sensor filter:**
 - Sensor filter
 - Cutoff frequency:** 30.0 Hz

Common configuration

1. Initial variance = 1.0

Minimum variance = 1.0E-4

2. Notch filter: It is a filter that dampens signals only at a specific frequency.

- **Mode:** Main frequency
- **Main Frequency:** 22.5
- **Bandwidth:** 1.0 Hz
- **Notch gain:** 6.0206 dB

3. Sensor filter: Enabled.

- **Cutoff frequency:** 30.0 Hz

BMI088 Accelerometer

This panel displays the possible parameters that can be configured for the internal BMI088 Accelerometer.

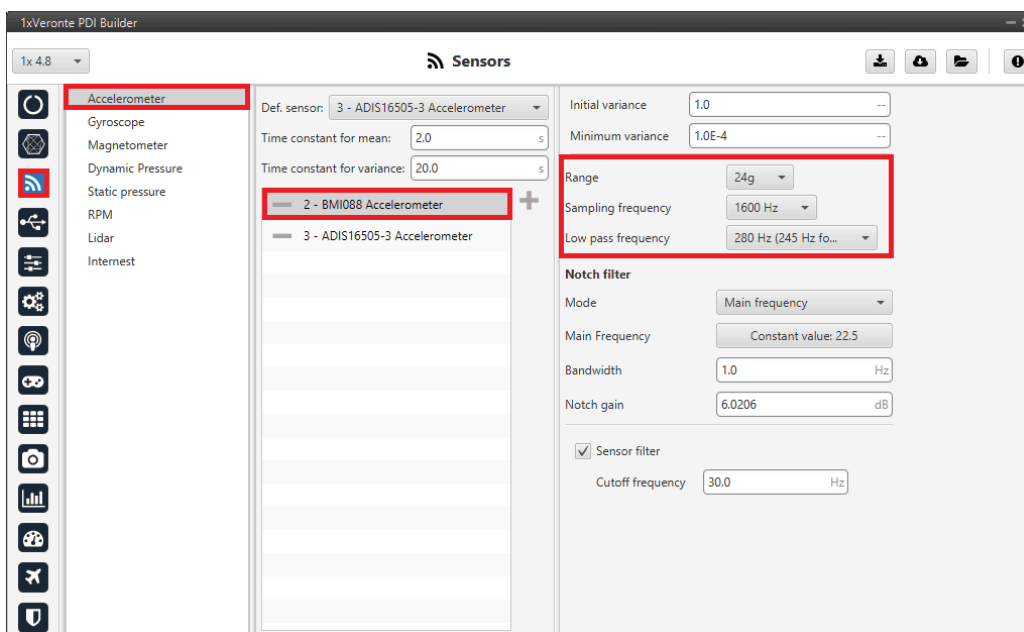

BMI088 Accelerometer Panel

- **Range:** We select a high range of forces that the accelerometer can measure. The lowest accuracy is accepted so that the system does not saturate.
- **Sampling frequency:** That is the frequency at which the measurements are read out. We recommend the highest (**1600Hz**).

- **Low pass frequency:** The cutoff frequency is set to **280Hz (245 Hz for the Z axis)**.

ADIS16505-3 Accelerometer

This panel displays the possible parameters that can be configured for the internal ADIS16505-3 Accelerometer.

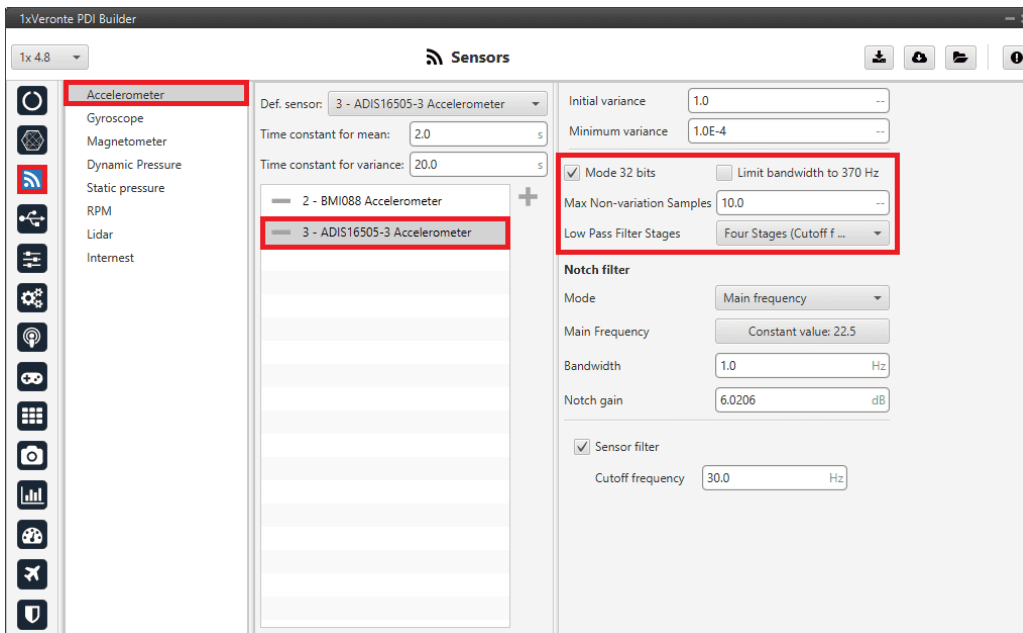

ADIS16505-3 Accelerometer Panel

- **Mode 32 bits:** Following the recommendation, we **enable** it.
- **Limit bandwidth to 370Hz:** Following the recommendation, we **disable** it.
- **Max Non-variation Samples:** This is configured manually.
- **Low Pass Filter Stages:** Following the recommendation, **4 stages (Cutoff f=40Hz)** are configured.

Gyroscope

Note

For a detailed explanation of the available gyroscope sensors, please visit the [Gyroscope - Sensors](#) section of the **1x PDI Builder** user manual.

The gyroscope from the IMU can be configured as explained in the panels shown below.

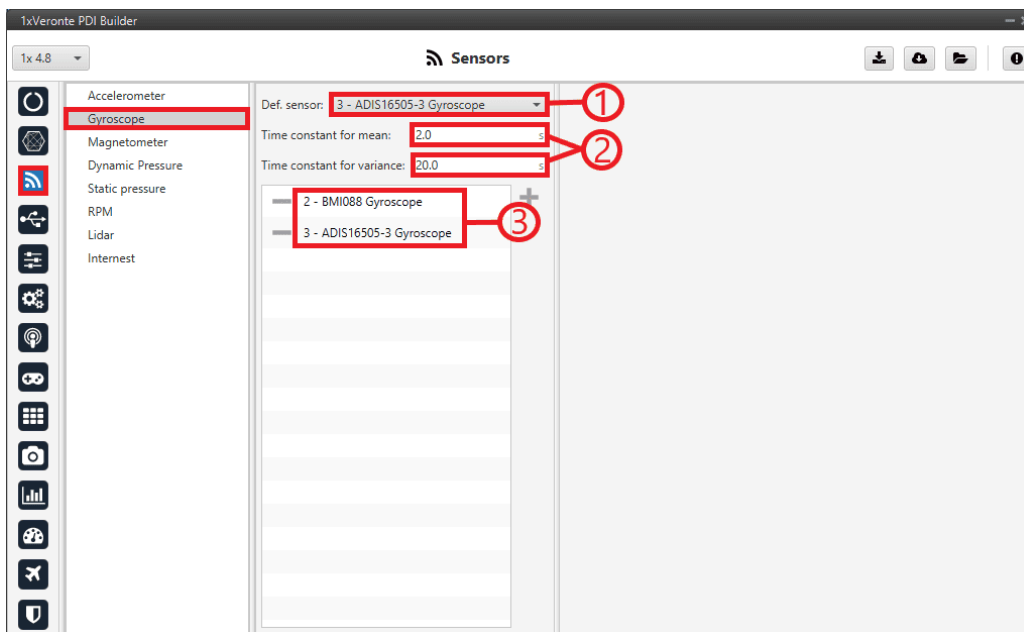

Gyroscope Panel

⚠ Important

It is recommended to select multiple of these sensors for the navigation algorithm, so that Veronte Autopilot 1x performs a combination of all the measurements of the selected gyroscopes.

This combination consists of calculating the means and variances of each of these gyroscopes in a given time (Time constant for mean and Time constant for variance) to obtain a weighted mean with the inverse of the variance. The lower the variance, the greater the weight of that sensor in the mean.

1. The ADIS16505-3 Gyroscope sensor has been chosen as the **default sensor**. If all other sensors fail, the measurement value will be that of the default sensor.
2. A time of 2 seconds has been defined for the **Time constant for mean**, and 20 seconds for the **Time constant for variance**.
3. The **BMI088** and **ADIS16505-3** gyroscopes sensors have been selected and their configuration is described below.

Common configuration of BMI088 Gyroscope and ADIS16505-3 Gyroscope

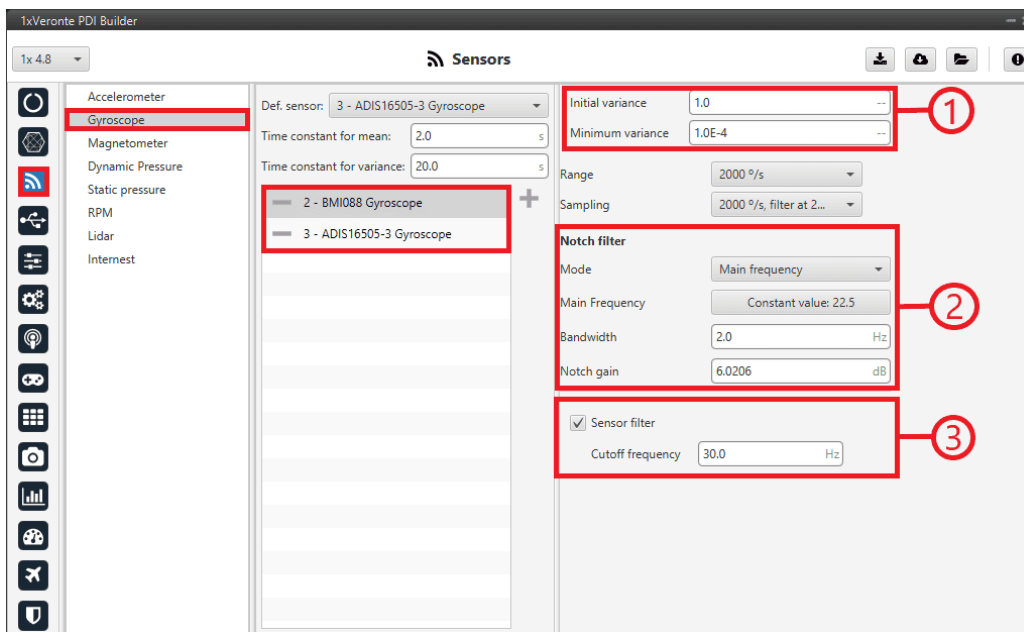

Common configuration

1. Initial variance = 1.0

Minimum variance = 1.0E-4

2. Notch filter: It is a filter that dampens signals only at a specific frequency.

- **Mode:** Main frequency
- **Main Frequency:** 22.5
- **Bandwidth:** 1.0 Hz
- **Notch gain:** 6.0206 dB

3. Sensor filter: Enabled.

- **Cutoff frequency:** 30.0 Hz

BMI088 Gyroscope

This panel displays the possible parameters that can be configured for the internal BMI088 Gyroscope.

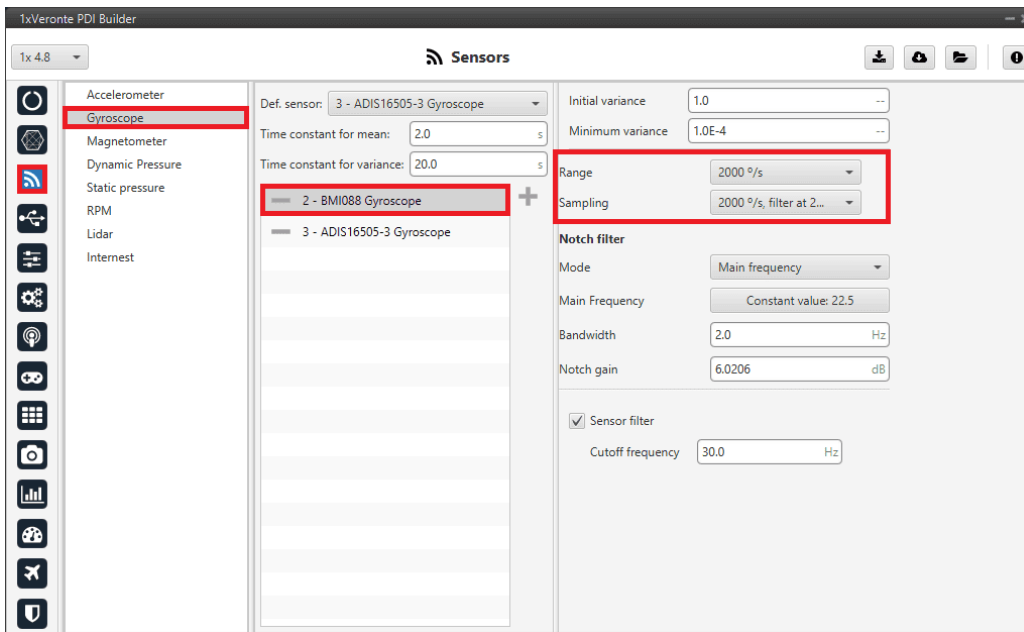

BMI088 Gyroscope Panel

- **Range:** We select a high performance range, **2000°s.** The lower accuracy is accepted so that the system does not saturate.
- **Sampling:** The angular velocity is set to **2000°s filter at 230 Hz.**

ADIS16505-3 Gyroscope

This panel displays the possible parameters that can be configured for the internal ADIS16505-3 Gyroscope.

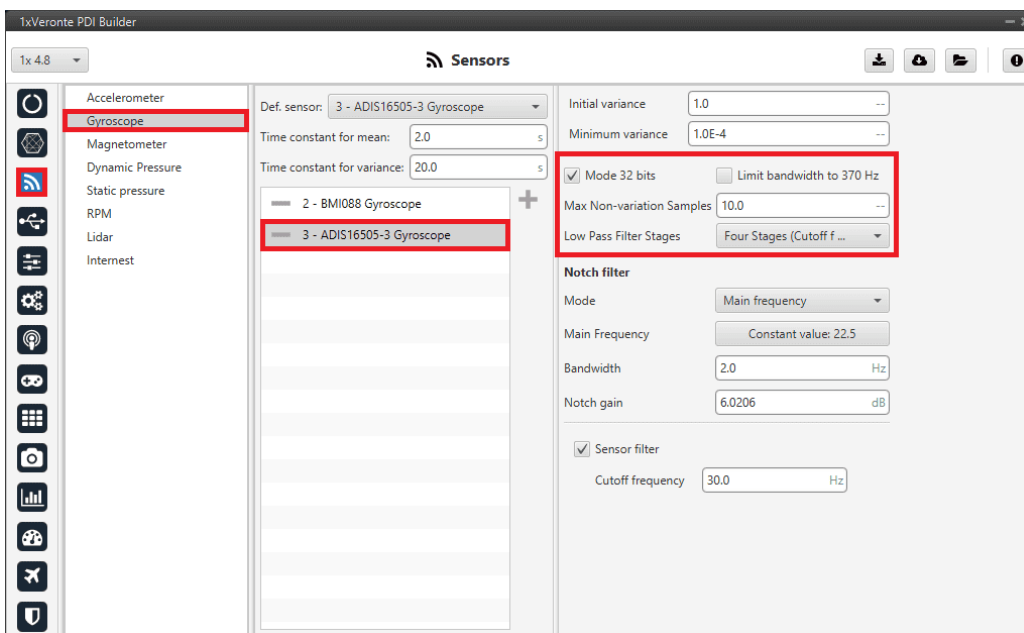

ADIS16505-3 Gyroscope Panel

- **Mode 32 bits:** Following the recommendation, we **enable** it.

- **Limit bandwidth to 370Hz:** Following the recommendation, we **disable** it.
- **Max Non-variation Samples:** This is configured manually.
- **Low Pass Filter Stages:** Following the recommendation, **4 stages (Cutoff $f=40\text{Hz}$)** are configured.

Magnetometer

It is not necessary to configure the magnetometer in this section. It is selected directly in the [Navigation program - Block programs](#).

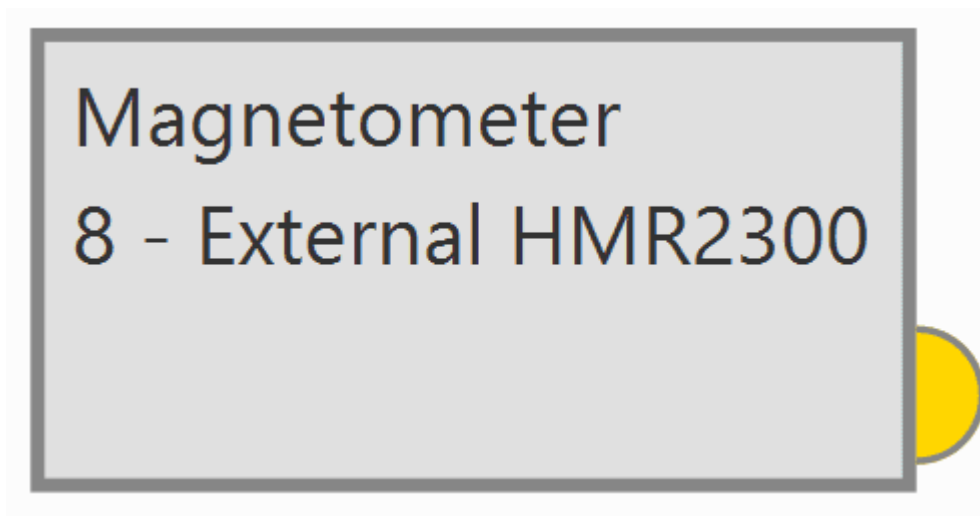

Dynamic Pressure

The Internal channel has been selected. In this case the Autopilot 1x uses a value provided by the internal sensor.

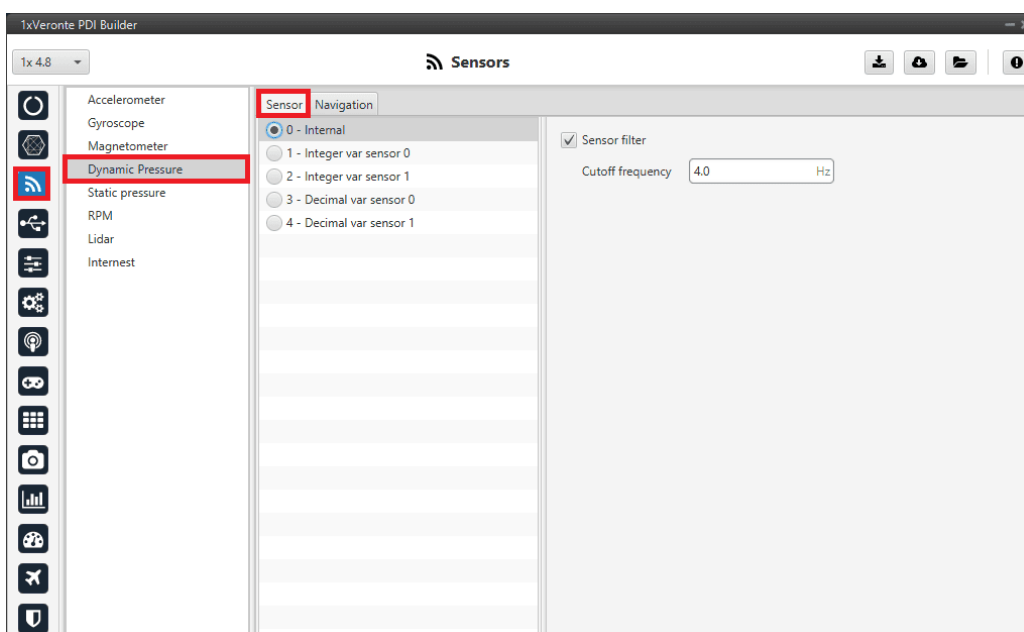

Sensor panel - Dynamic Pressure

A **cutoff frequency** of **1.0 Hz** has been defined in the **Sensor** panel for the low pass filter. It is necessary to **enable** the **sensor filter** to be able to define the cutoff frequency.

The image below shows a basic configuration of the **Navigation** panel.

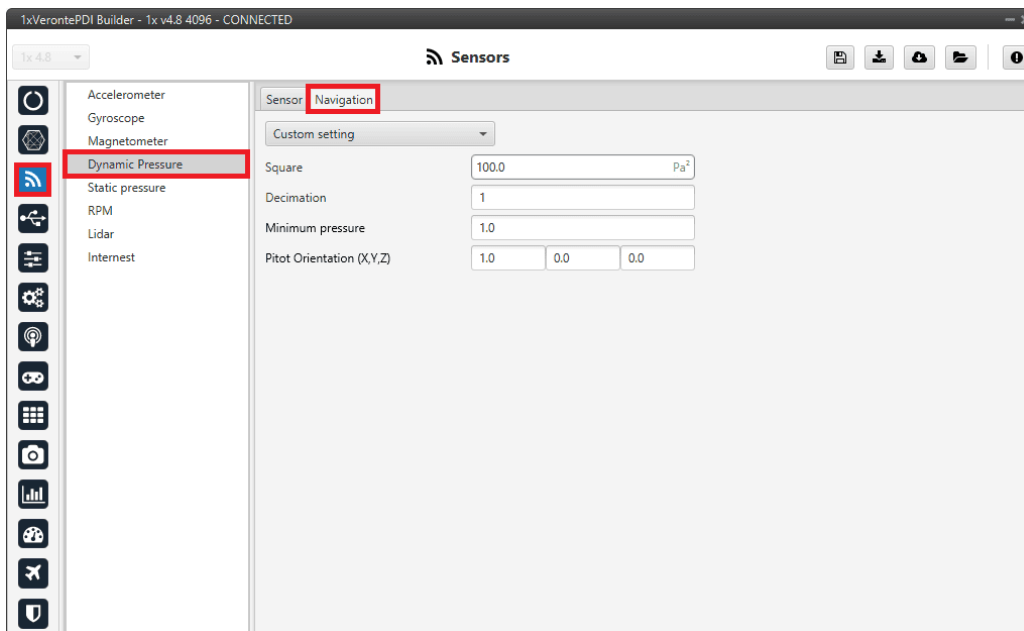

Navigation panel - Dynamic Pressure

Note

For a detailed explanation of the available dynamic pressure sensors, please visit the [Dynamic Pressure - Sensors](#) section of the **1x PDI Builder** user manual.

Static Pressure

It is not necessary to configure the Static Pressure sensor in this section. It is selected directly in the [Navigation program - Block programs](#).

Static Pressure Sensor 2 - Internal Sensor (DPS310)

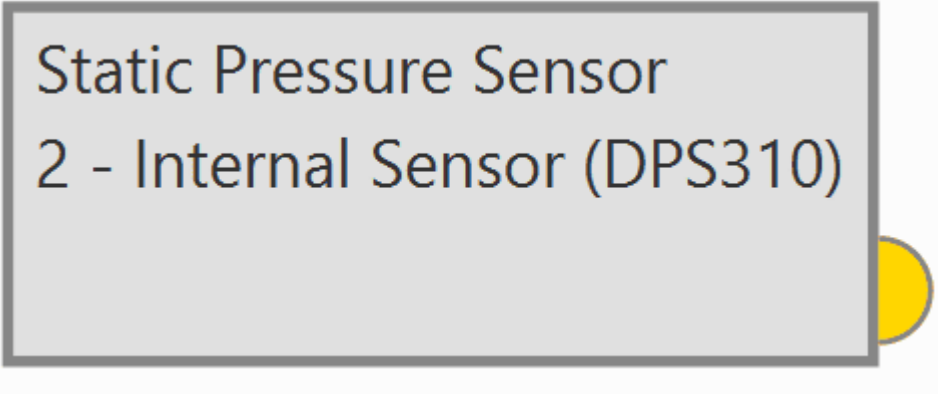

HIL Configuration

[HIL Simulator](#) is the Veronte application that allows Veronte Autopilot 1x to communicate with a simulator acting as a "bridge" between both. Therefore, users must configure this menu to simulate the performance of the Embention VTOL aircraft 1x in the selected simulator, in this case X-Plane11 has been chosen. For more information, please visit [HIL Simulator](#) user manual.

To configure the simulation variables follow the steps below:

1. Find the **simulator variables** that have been configured in the aircraft model.

Once found, drag and drop each of them into the **To Simulator** panel. In this panel users can see all the variables selected to be sent to the simulator.

For Embention VTOL Aircraft select the following variables:

- Rotor RPM 1
- Rotor RPM 2
- Rotor RPM 3
- Rotor RPM 4
- Rotor RPM 5
- Aileron Right 1
- Aileron Left 1

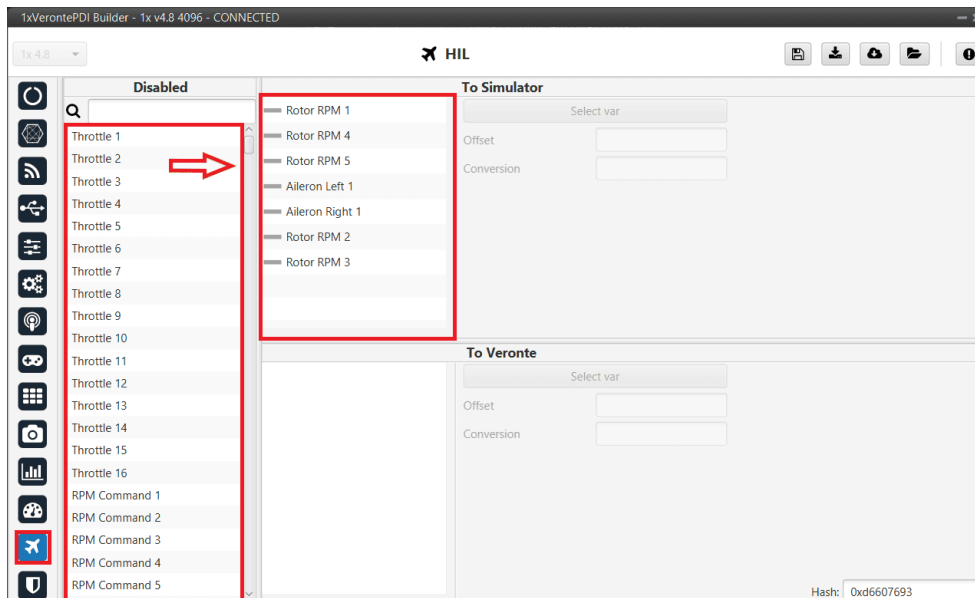

Simulator variables

- Associate each actuator variable (Control Output) of Autopilot 1x that matches that of the simulator.

Note

The variables that have been assigned in the [Control to servo program](#) to each actuator are the ones to be linked to the simulator internal variables.

- Rotor RPM 1 ⇒ Motor 1 XPlane
- Rotor RPM 2 ⇒ Motor 2 XPlane
- Rotor RPM 3 ⇒ Motor 3 XPlane
- Rotor RPM 4 ⇒ Motor 4 XPlane
- Rotor RPM 5 ⇒ Pusher motor Xplane
- Aileron Right 1 ⇒ Right Elevator
- Aileron Left 1 ⇒ Left Elevator

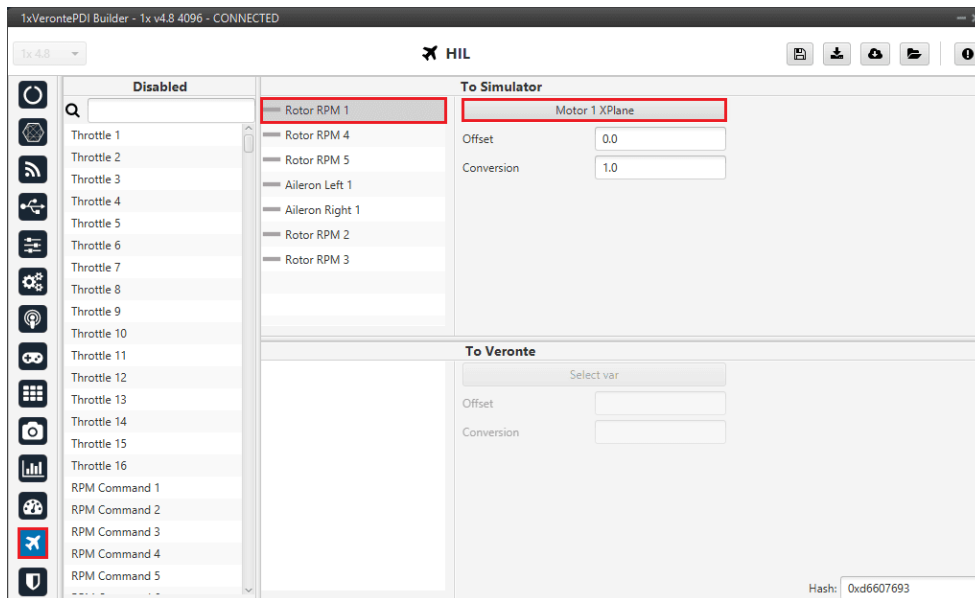

Autopilot 1x variables

3. Set the **Offset** and **Conversion** variables if necessary.

To adjust the aircraft performance to the simulation, a **conversion** factor of **-1.0** has been defined for both **elevators**. This factor allows the simulation to match the actual aircraft conditions.

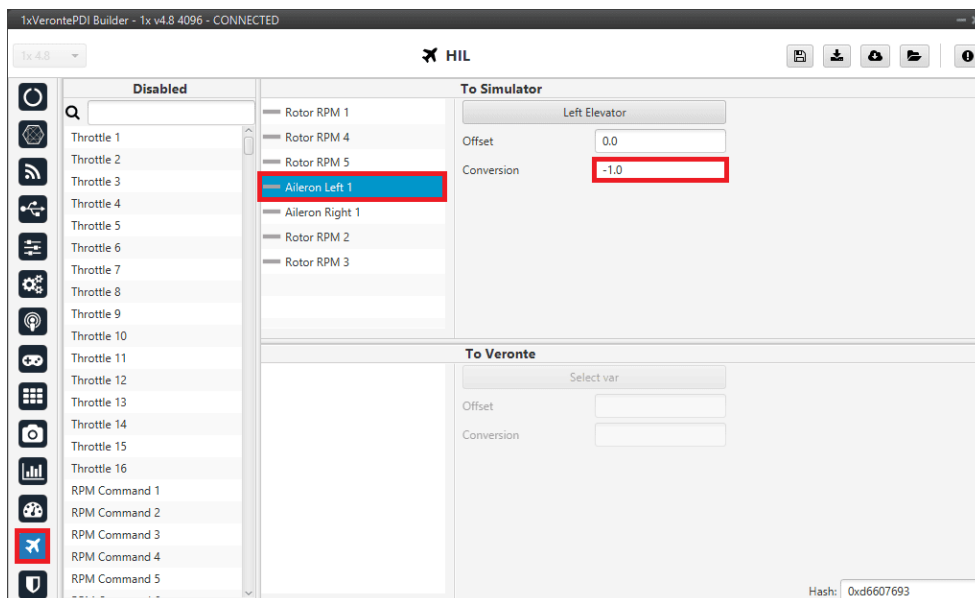

Conversion - Right elevator

For more information on this menu, visit the [HIL](#) section of the **1x PDI Builder** user manual.

Checklist

This feature is used to ensure that certain requirements have been accomplished, for example, prior to a phase change or to avoid a possible malfunction.

The checklist configured here will appear in **Veronte Ops** in the **Checklist** widget. For more information on this, visit [Veronte Ops](#) manual.

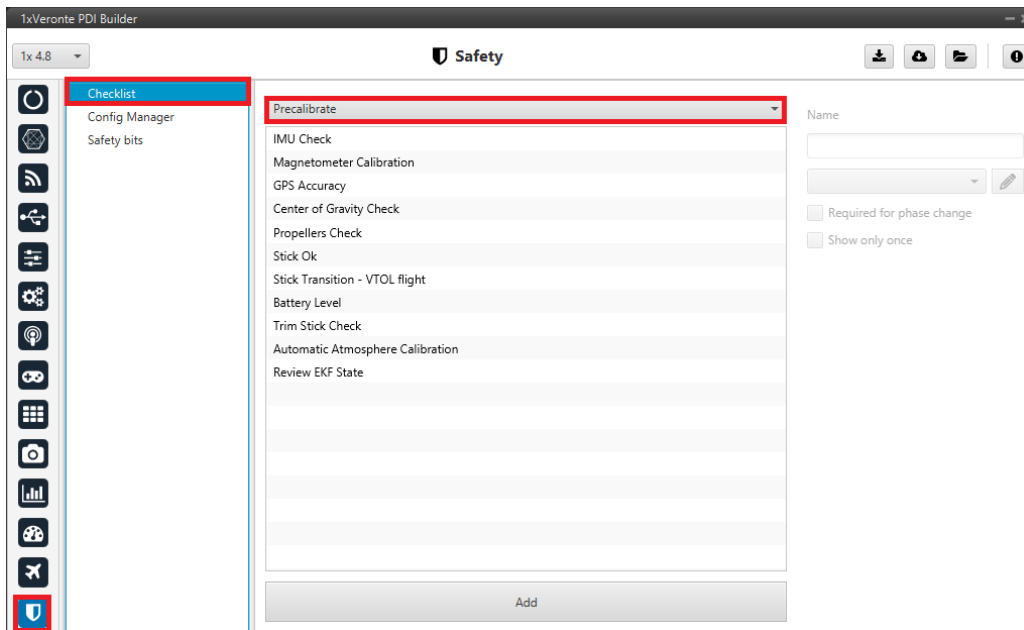

Checklist panel

In this configuration, a basic Checklist has been defined. In it, 2 different types of checks are configured, checks for operator information only (None) and checks automatically performed by Veronte Autopilot 1x (In Range check).

In the **Precalibrate** phase, the following checks are established:

- IMU Check ⇒ None
- Magnetometer Calibration ⇒ None
- GPS Accuracy ⇒ None
- Center of Gravity Check ⇒ None
- Propellers Check ⇒ None
- Stick Ok ⇒ **In Range Check**
 - Check performed automatically if the Stick Not Detected variable is in the range [0.9 - 1.1].

- Stick Transition - VTOL flight ⇒ **In Range Check**
 - Check performed automatically if the Stick - Transition variable is in the range [0.0 - 0.4].
- Battery Level ⇒ **In Range Check**
 - Check performed automatically if the Power Input variable is in the range [23.8 - 26.0].
- Trim Stick Check ⇒ None
- Automatic Atmosphere Calibration ⇒ None
- Reviw EKF State ⇒ None

For more information on the Checklist options, visit the [Safety - Configuration](#) section of the **1x PDI Builder** user manual.

Operation

This section will explain how to design a basic operation in **Veronte Ops**, as well as the different automations and events that can be combined to allow Autopilot 1x to guide the aircraft according to the desired laws.

Veronte Ops is an application for vehicle **operation and monitoring** during missions. For more information, visit the [Veronte Ops](#) user manual.

To familiarize the user with the basic functioning of this tool, 3 operations will be explained as examples. Previously, the following steps must be followed to start designing an operation:

1. Download, install and open **Veronte Ops**.

There are 2 ways to work with this application: as a website app or by installing it throught an executable.

Hint

It is recommend to use the **executable** version if working **offline**.

For more information, visit the [Download and Installation - Quick Start](#) section of the **Veronte Ops** user manual.

2. Connect Autopilot 1x to the PC (usually via USB) for design operation.
For more information on this connection, visit the [Basic connection for operation - Quick Start](#) of the **1x Hardware Manual**.

- In order to work with the autopilot with Veronte applications, it is first necessary to configure **Veronte Link** to recognize it. If users need more details on how do this, visit the [Serial connection - Integration examples](#) section of the **Veronte Link** user manual.

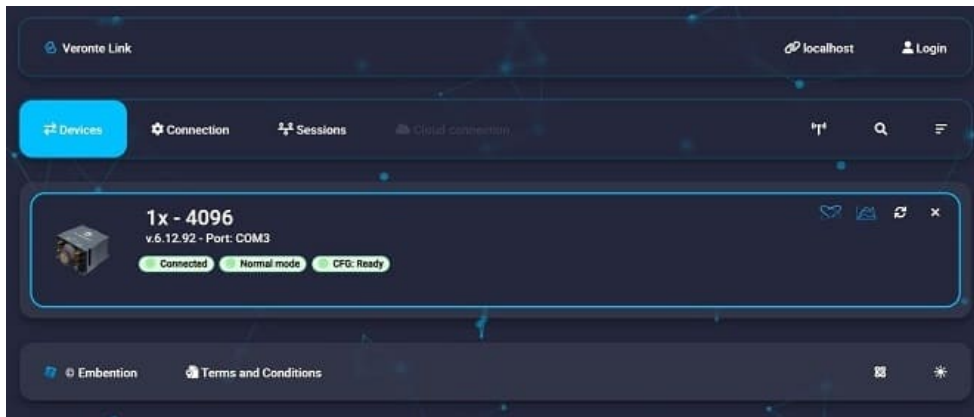

Operation - Veronte Link

- Once the autopilot is recognized in **Veronte Link**, it will appear in Veronte Ops to be selected:

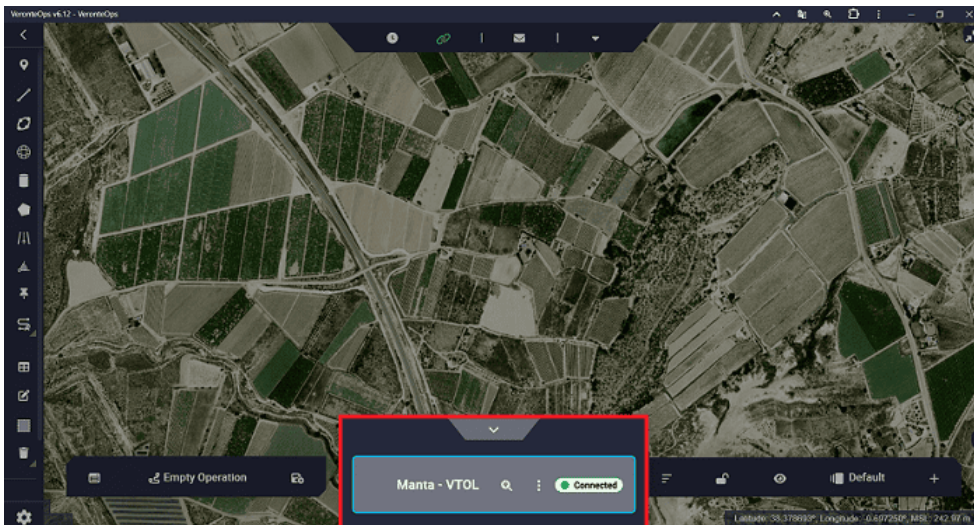

Operation - Platform selected

For more information, visit the [Platform - Panels](#) section of the **Veronte Ops** user manual.

- Finally, navigate on the map to the location where the mission is to be created.

Followed these steps, the following three operations are defined:

- Operation 1.** This is a simple operation, in which the aircraft performs a mission consisting of a closed loop passing through all flight phases.

- [Operation 2](#). In this operation, the different options offered by the **areas tools** (Sphere, Cylinder, Prism) will be used. These can be linked to an automation or defined as **obstacles**.
- [Operation 3](#). This operation combines the use of the **marks** option and automations to create an operation composed of two missions.

Once the operation is configured, it is necessary to **save and upload** it to Autopilot 1x. To do that, users must use the following options available in the **Operation Panel**:



Operation panel actions

1.  **Save Operation:** Click on it to apply any change if necessary.
2.  **Upload to:** Click on it to update the loaded operation in Autopilot 1x with the new **saved changes**.

Note

This option will only be available if the changes made have been previously saved, i.e. the **Save Operation** option must have been used.

The following message indicates that the operation configuration has been uploaded successfully.



Configuration Saved

For more information, visit the [Operation actions - Operation](#) section of the **Veronte Ops** user manual.

Finally, to start flying, it is useful to create a **Workspace** to control the mission. The [Workspace](#) section of this manual presents the main elements advised for setting up a workspace.

For more information, visit the [Workspace - Panels](#) section of the **Veronte Ops** user manual.

Operation 1

This operation will be defined as a closed route in figure of **8**. It is a simple and basic mission that will serve as an example to learn how to use the Veronte Ops application.

Mission

Once the desired location for the mission has been selected, there are two ways to create an **8** figure route:

- [Generate route](#) option.
- [Segments](#) option.

Generate route

This option allows to create missions with predefined routes:



Photogrammetry and



Figure.

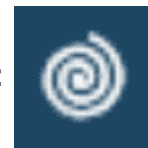

Spiral,

Follow the steps below to define the mission using the [Generate route](#) option:

1. Go to Mission Toolbar → Generate route → **Create figure.**
Click and drag to create the figure in the desired location.

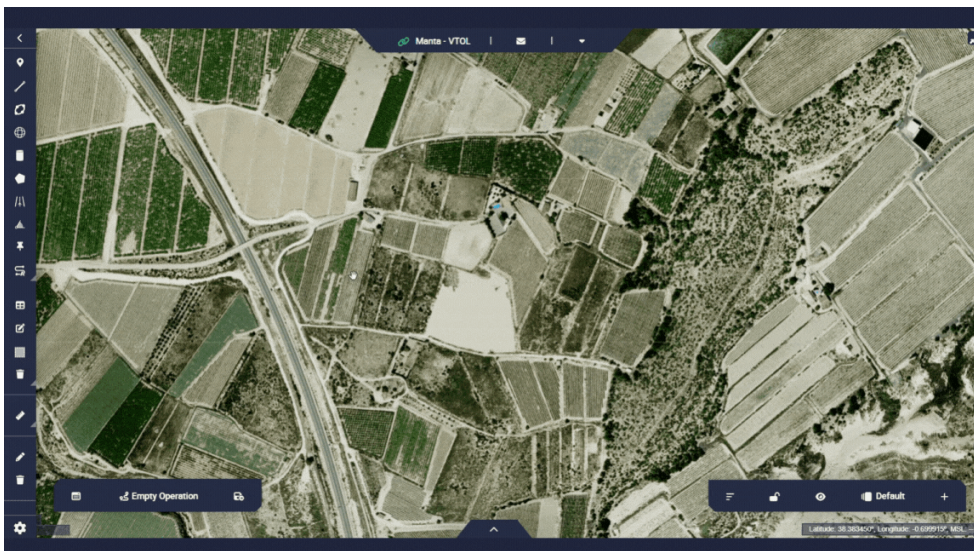

Operation 1 - Create Figure

2. Configure the **Figure Settings**.

For more information on the parameters to be configured, visit the [Generate route - Operation](#) section of the **Veronte Ops** user manual.

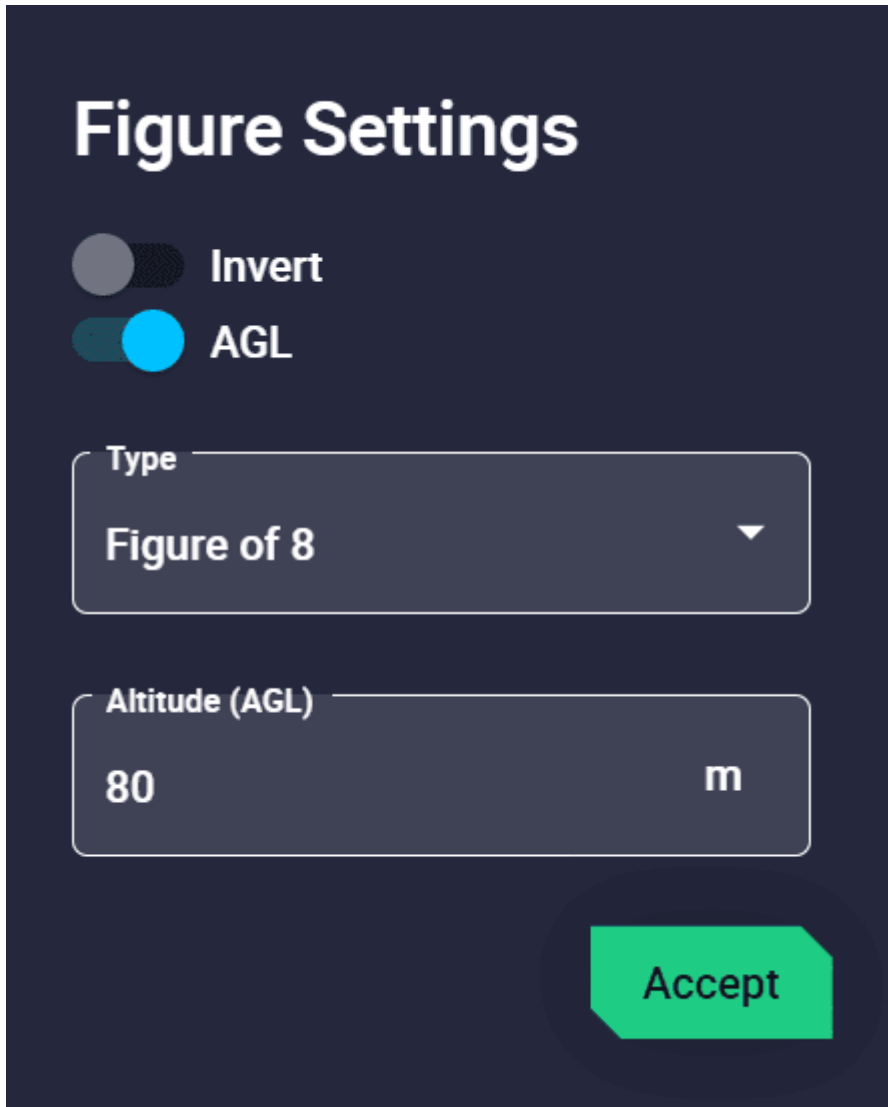

Figure Settings

Invert

AGL

Type

Figure of 8

Altitude (AGL)

80 m

Accept

Operation 1 - Figure Settings

3. Use the [Edit Mission](#) option  in the Mission Toolbar if the user wants to edit the location of a waypoint or the curvature of the route.



Operation 1 - Edit Mission

Segments

This option allows the user to define the location and altitude of each waypoint, thus defining the mission in more detail.

Follow the steps below to define the mission using [Segments](#).

1. Go to Mission Toolbar → **Segment**.

Set as many segments as wished. These segments, separated by waypoints, will draw the mission.

Hint

Set the segments following the desired direction of the route.



Operation 1 - Segment

2.

Use the [Edit Mission](#) option

in the Mission Toolbar if the user

wants to edit the location of a waypoint and the curvature of the route.

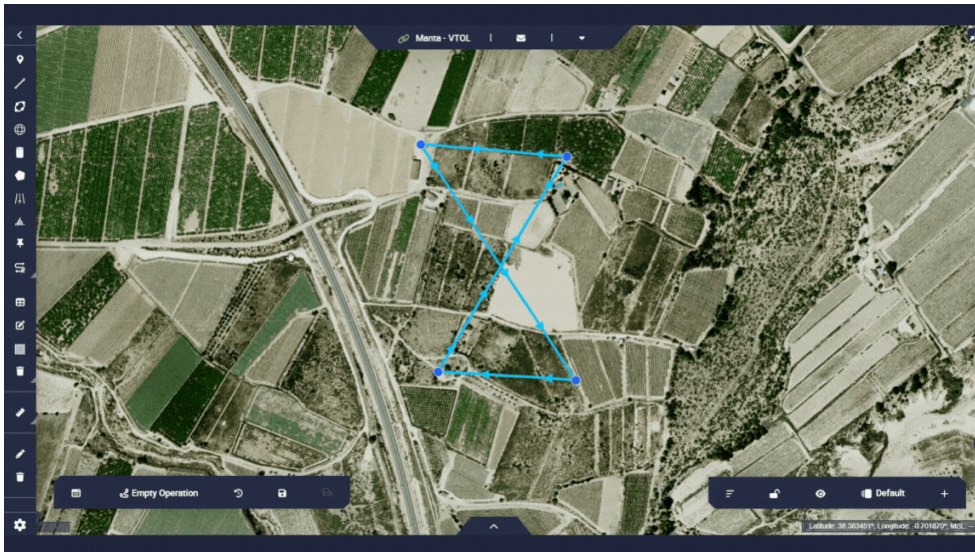

Operation 1 - Edit Mission

3. Check the altitude of the route waypoints with respect to the ground, **to make sure that the route is feasible**, i.e. does not interfere with the terrain.

To do this, right-click on any waypoint of the route → **Open elevations.**

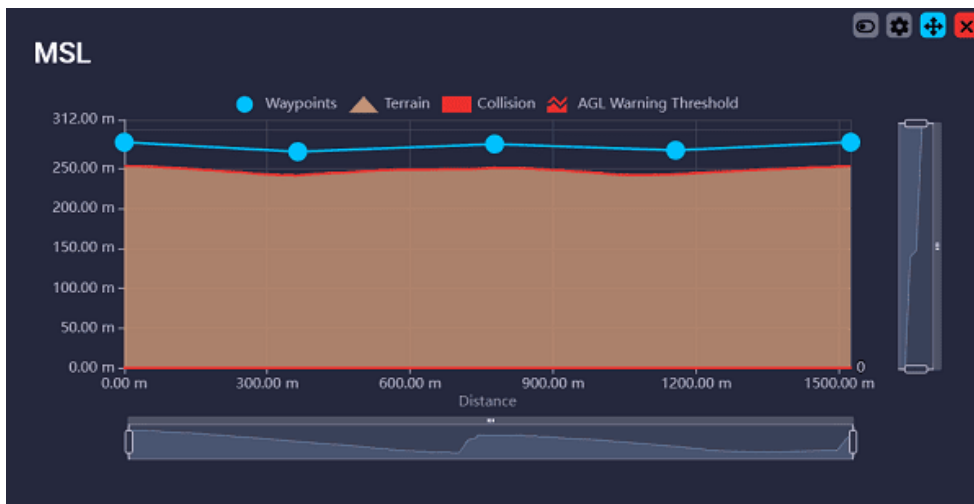



Operation 1 - Elevations panel

4. Configure the settings for each waypoint to define its altitude and location.

To do this, right-click on a waypoint → **Waypoints Settings.**

Operation Custom Point 5

Absolute Relative

Set coordinate

Type
Decimal degrees

Latitude (DD)
38,38473787775995

Longitude (DD)
-0,69738738652268

Set elevation

▲ MSL terrain: 253.74

WGS84
334,31 m

334.31 meters

MSL
283,74 m

283.74 meters

AGL
30 m

30 meters

Cancel Confirm

Operation 1 - Waypoints Settings

For more information on the parameters to be configured, visit the [Waypoint - Operation](#) section of the **Veronte Ops** user manual.

Start Route

The user must define a waypoint as the start of the route. This will be the point where the aircraft will start the Cruise phase.

⚠ Important

If this point is not defined, **Veronte Ops** will not allow the operation to be saved.

To define a waypoint as the start of the route, right click on the desired waypoint to be the start of the route → Select the **Set Start Route** option:

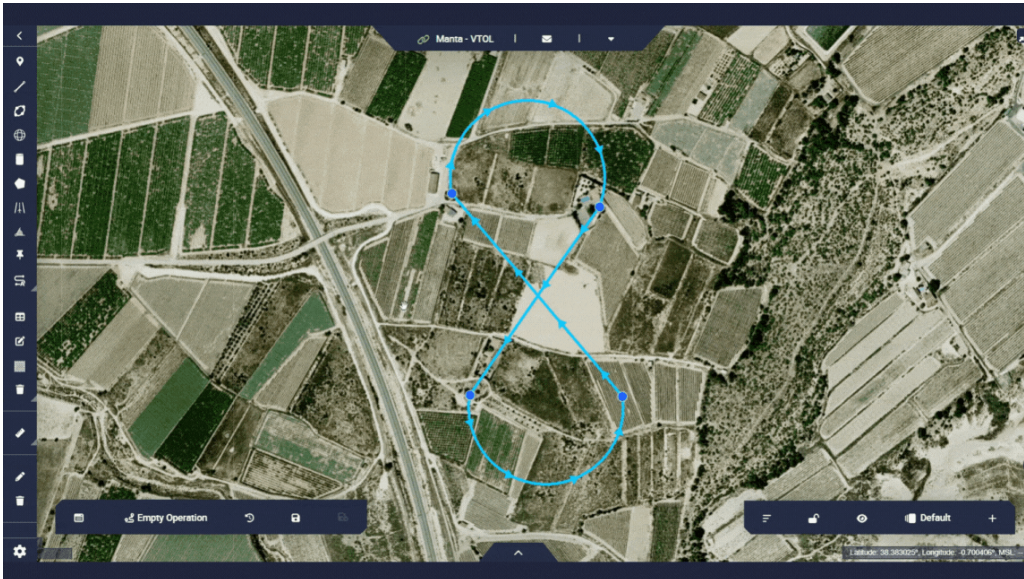

Operation 1 - Start Route

Runway

For the operation of the Embention VTOL aircraft it is necessary to define a runway since in the Approach phase a route will be generated to guide the aircraft to fly to it.

Follow the steps below to define a runway:

1. Go to Mission Toolbar → **Set a Runway.**
2. Click on the map to define the start point of the runway → Click on a second point to define the end of the runway.
3. Use the [Edit Mission](#) option  to locate the Loiter point where the user wants it to be.
This will be the point around which the Loiter will take place.

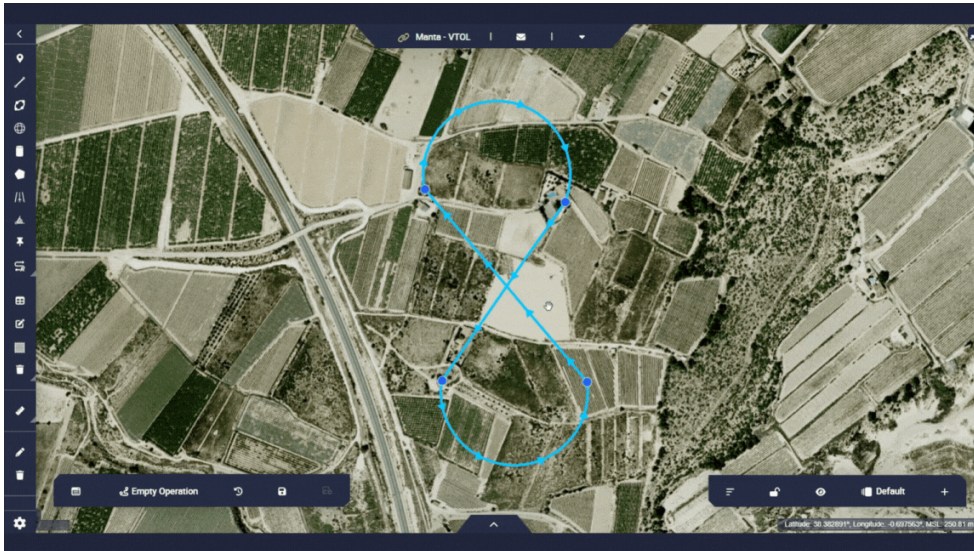

Operation 1 - Runway

4. Go to Operation Panel → Customize → **Runway**.

Link the runway defined in the **1x PDI Builder** configuration with the just created runway.



Operation 1 - Set runway

Note

Adjust the runway parameters so that the aircraft performs the desired operation.

For more information on the parameters to be configured, visit the [Runway - Operation](#) section of the **Veronte Ops** user manual.

Home Point

The Home point will be the point used to execute the **Compute RTH** program of the **1x PDI Builder** configuration. This will be the point to which the Autopilot 1x will guide the aircraft in the Return to Home phase.

Follow the steps below to define a waypoint as Home point:

1. Go to Mission Toolbar → **Waypoint**.
2. Click on the map to set a waypoint.

Note

The user also has the option to use an existing waypoint.

3. Go to Operation Panel → Customize → **Custom Points**.

Link the Home point defined in the **1x PDI Builder** configuration with the desired waypoint.



Operation 1 - Home Point

Note

If the user does not define this point, Autopilot 1x will guide the aircraft to the **take-off point** in the Return Home phase.

Operation 2

This operation implements some of the main functionalities of the **areas** option. Generally, these areas are used as **events** that trigger an action, or as **obstacles** that the guidance program will avoid flying over.

As an example, two areas will be added to the [Operation 1](#) mission:

- [Area 1](#) → Within this area the aircraft will switch directly to the **Return to Home** phase.
- [Area 2](#) → Area defined as **obstacle**, the autopilot system will prevent the aircraft from entering this area.

Important

To configure the **areas with events and actions** in **Veronte Ops**, it is necessary to first define them in the [Operation elements panel](#) of the **UI menu** of the **1x PDI Builder** app.

Note

In this case, the areas used will be cylinders, although they can also be prisms or spheres following the same steps.

Area 1

1. In the 1x PDI Builder app → go to UI menu → Operation elements panel → **Cylinders tab**.

Define the area by setting a **custom name**:

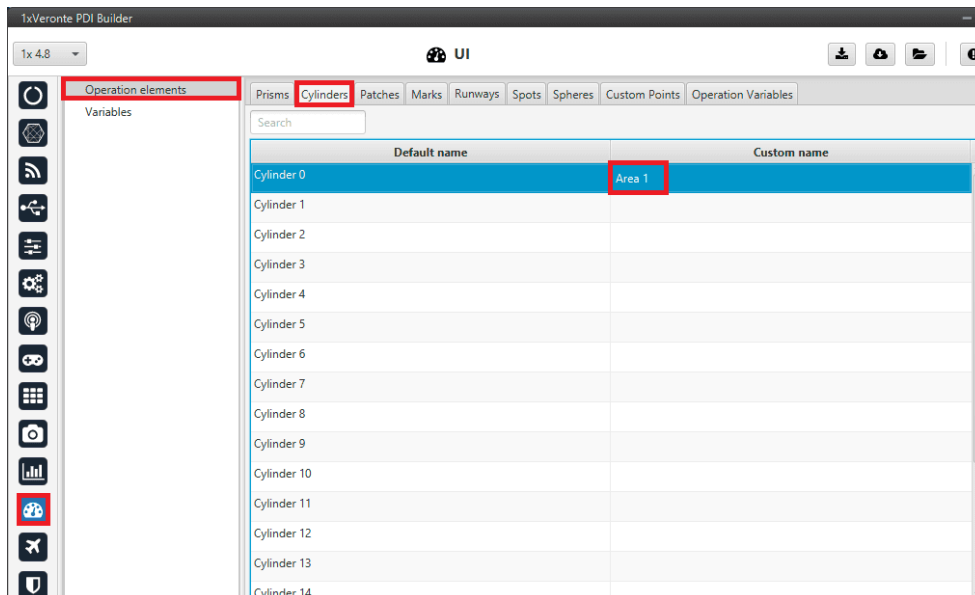

Operation 2 - UI menu

2. In the 1x PDI Builder app → go to **Automations menu**.

An automation will be created for the autopilot to pass to the Return to Home phase when it is inside Area 1:

- Create a **new automation**.

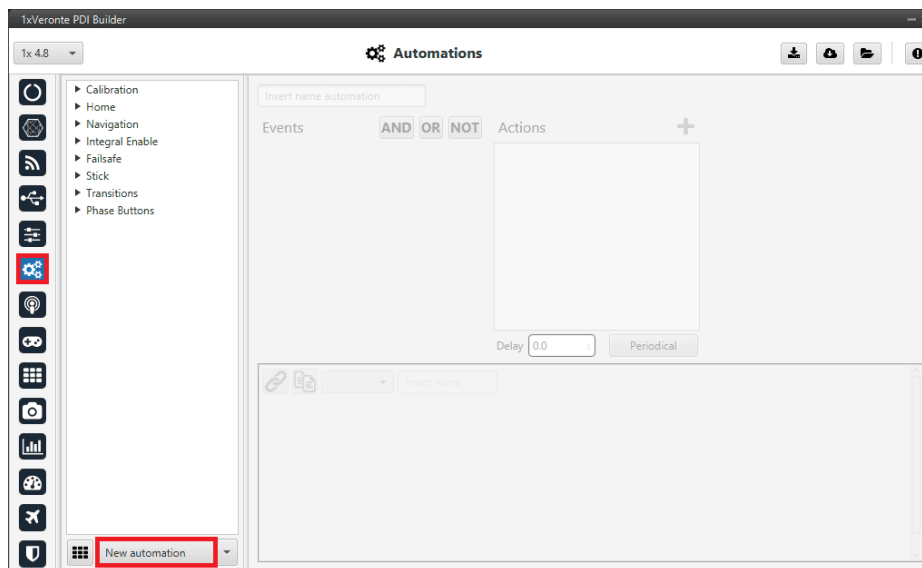

Operation 2 - New Automation

- To configure the desired event, select the **Area** as the event type and choose the **Inside** type, since the event is that the **aircraft is inside area 1**.

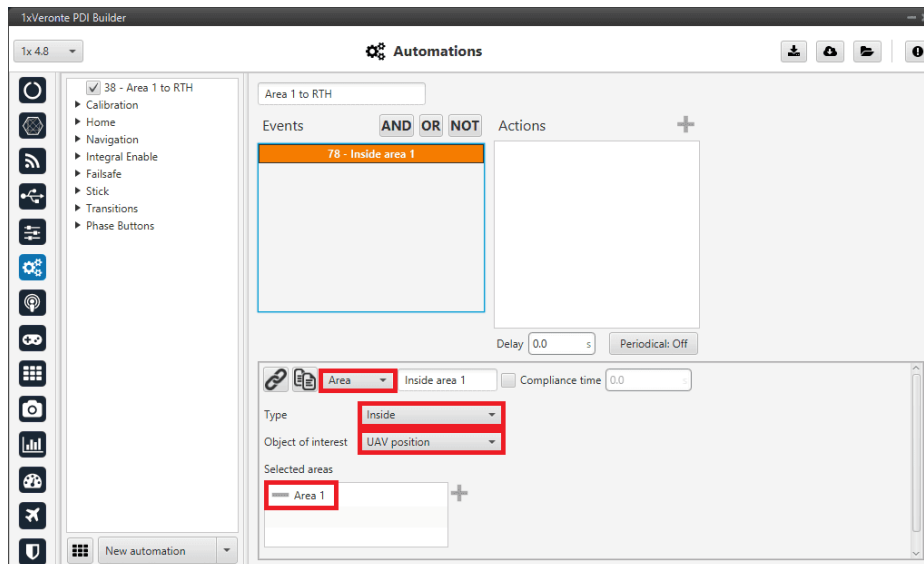

Operation 2 - Event

- Define an **action** of type **Phase**. In this case, the action is to change to Return Home phase.

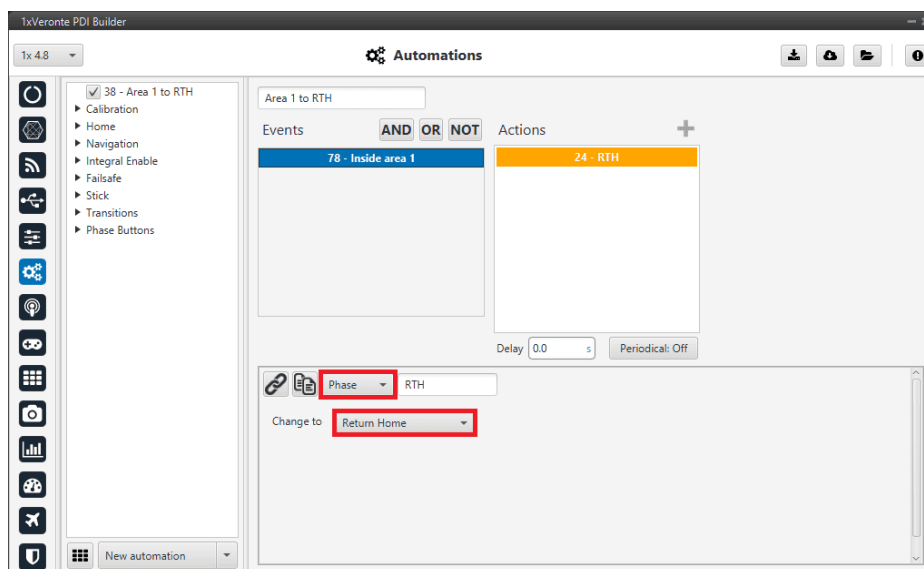

Operation 2 - Action

For more information, visit the [Automations - Configuration](#) section of the **1x PDI Builder** user manual.

- Save the configuration so that the changes made will appear in **Veronte Ops**.
- Create the area in **Veronte Ops** (in the mission created for [Operation 1](#)).

For this:

In Veronte Ops → go to Mission Toolbar → **Set a Cylinder**.

Click and drag to set a cylinder to the desired position.

5. Use the [Edit Mission](#) option  of the Mission Toolbar if the user wishes to edit the exact location and radius of the cylinder.



Operation 2 - Cylinder

6. Configure the cylinder by setting its height and radius.
For more information on the parameters to be configured, visit the [Cylinder - Operation](#) section of the **Veronte Ops** user manual.
7. Go to Operation Panel → Customize → Areas → **Cylinders**.
Link the area defined in the **1x PDI Builder** configuration to the just created cylinder.



Operation 2 - Set cylinder

Area 2

1. Create the area in **Veronte Ops** (in the mission created for [Operation 1](#)).
For this:

In Veronte Ops → go to Mission Toolbar → **Set a Cylinder**.

Click and drag to set a cylinder to the desired position.

2. Use the [Edit Mission](#) option  of the Mission Toolbar if the user wishes to edit the exact location and radius of the cylinder.

3. Right click on the configured cylinder → Select **Set Obstacle** option.

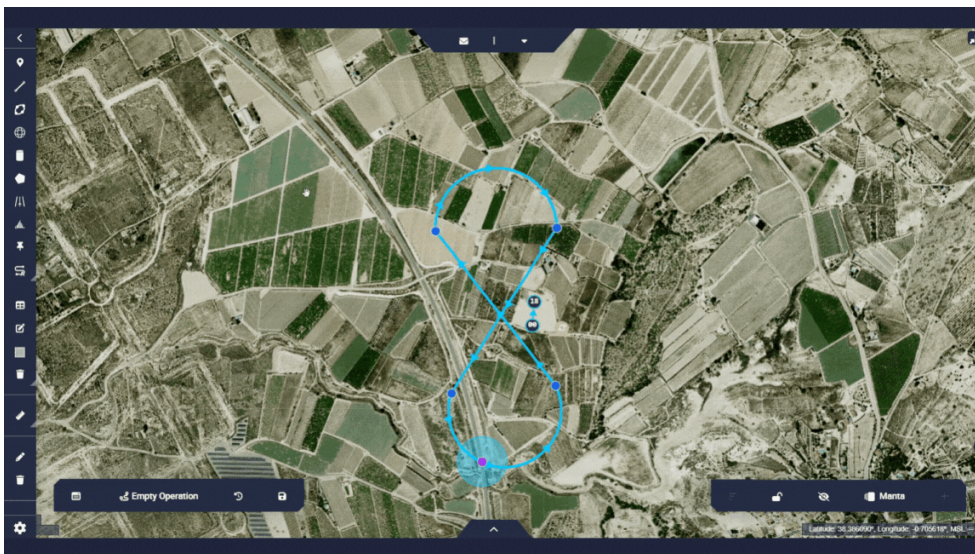

Operation 2 - Obstacle

4. Configure the cylinder by setting its height and radius.
For more information on the parameters to be configured, visit the [Cylinder - Operation](#) section of the **Veronte Ops** user manual.

Note

It is also possible to create an automation associated to an obstacle. To do so, once the area has been defined as an obstacle, follow the steps explained in [Area 1](#) to create the automation.

Operation 3

This operation implements some of the functionalities offered by the combination of the **Automations** with the **Mark** option of the Mission Toolbar.

To explain this tool, an operation composed of two missions with closed circuits is created.

In the first mission, which is the same as the one created for [Operation 1](#), the **Mark A** is defined. Then, when the aircraft achieves this mark an automation will send the aircraft to move to the second mission. In this second mission, the **Mark B** will be defined from which the aircraft will start the **Approach** phase.

Missions

As mentioned above, two closed circuits are defined:

- The first circuit with the figure of [8](#).
- The second circuit, at the same altitude as the first one, with the figure of [Racetrack](#).

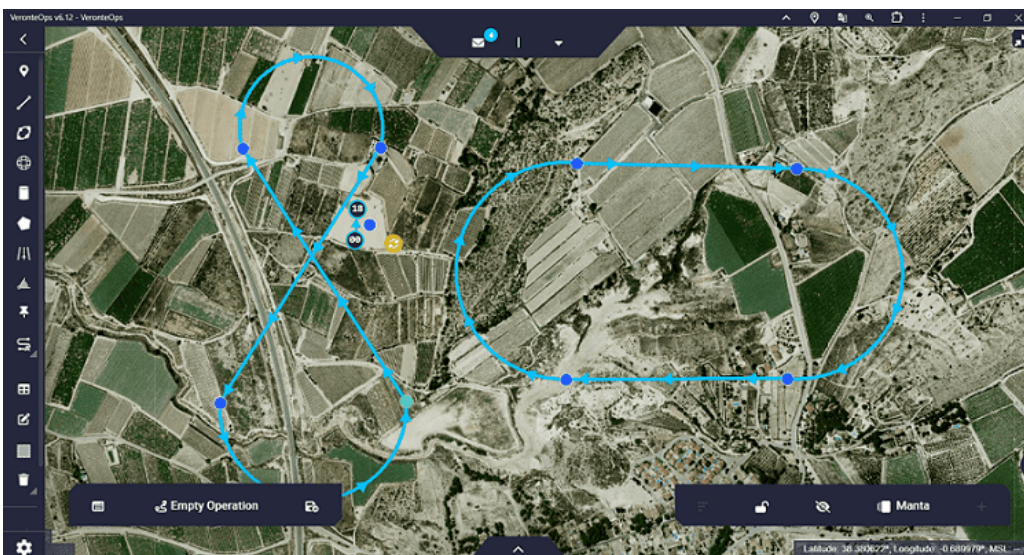

Operation 3 - Missions

Mark A

The operation starts with the route of the first mission, therefore, a point of this circuit is defined as the [Start Route](#). At one point on this route the **Mark A** is defined.

Follow the steps below to define the mark and the automation associated with it:

1. First it is required to define the mark in the **1x PDI Builder** configuration.

In the 1x PDI Builder app → go to UI menu → Operation elements panel → **Marks tab**.

Define the mark by setting a **custom name**.

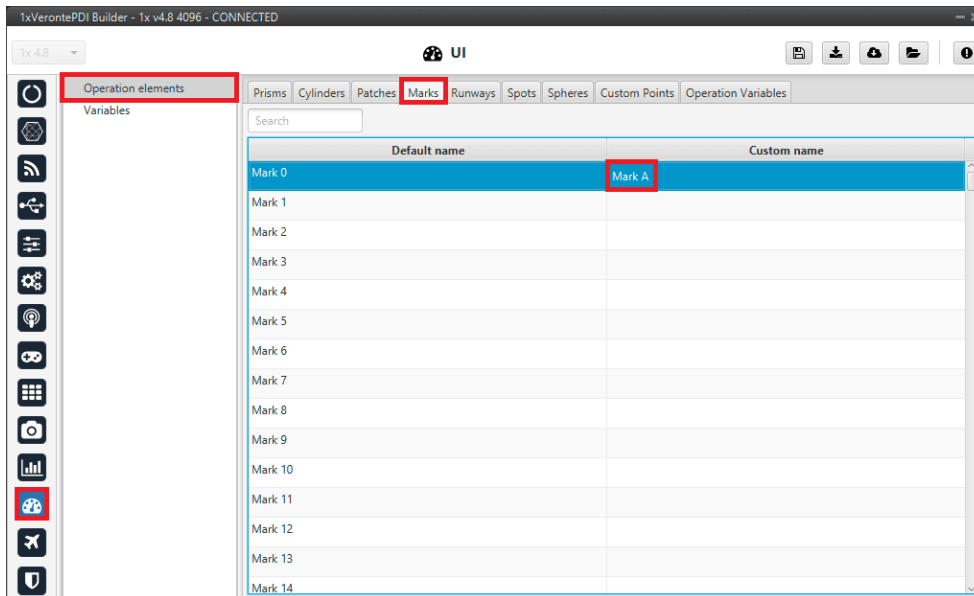

Operation 3 - Mark A definition

- It is also necessary to define the **patch** where the autopilot will guide the aircraft when it reaches **Mark A**.

In the 1x PDI Builder app → go to UI menu → Operation elements panel → **Patches tab**.

Define the patch by setting a **custom name**.

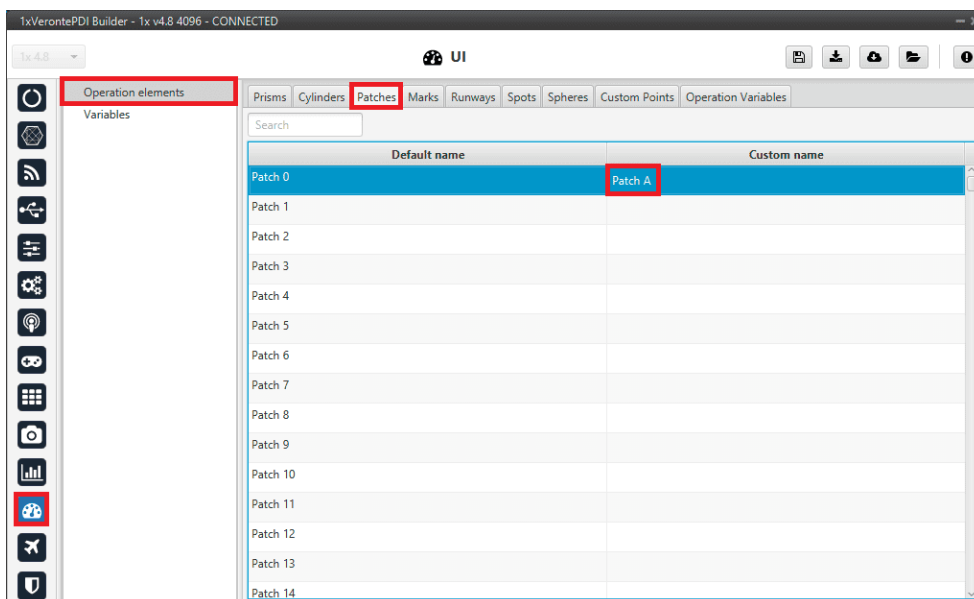

Operation 3 - Patch A definition

- In the 1x PDI Builder app → go to Automations menu → **New automation**.

An automation will be created so that, once this mark is achieved, the aircraft **will go to** the desired point:

- To configure this event, select the **Route** type and choose the **mark achieved** option.

For more information, visit the [Route - Events](#) section of the **1x PDI Builder** user manual.

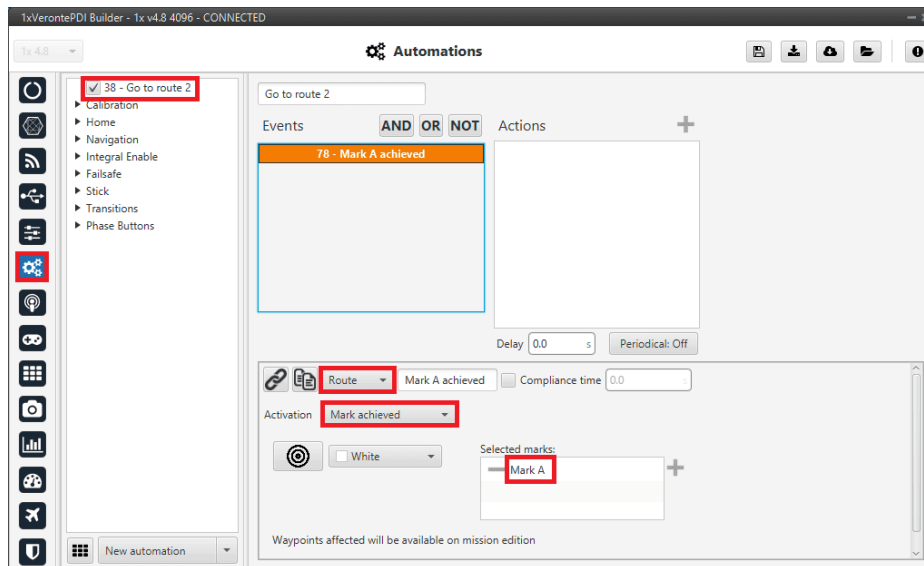

Operation 3 - Mark A event

- To define the action triggered by the event, set up a **Go to** action. This action guides the aircraft to the selected **patch**. For more information, visit the [Go to - Actions](#) section of the **1x PDI Builder** user manual.

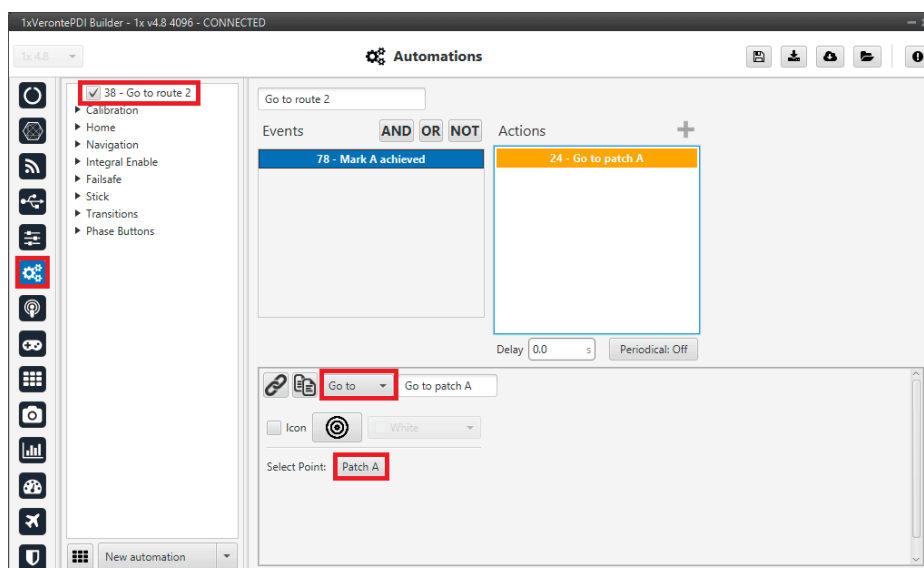

Operation 3 - Mark A action

4. Save the configuration so that the changes made will appear in **Veronte Ops**.

5. Create the mark in **Veronte Ops**. For this:

In Veronte Ops → go to Mission Toolbar → **Mark**.

Click on the desired patch to place a mark on the route.

Then, with the **Edit Mission** option



of the Mission Toolbar, users

can more precisely place the mark.



Operation 3 - Mark A creation

6. Go to Operation Panel → Customize → **Marks**.

Link the mark defined in the **1x PDI Builder** configuration with the just created mark.



Operation 3 - Set Mark A

7. Go to Operation Panel → Customize → **Patches**.

Link the patch defined in the **1x PDI Builder** configuration to the desired patch where the autopilot will guide the aircraft. In this case, a patch from the second mission.

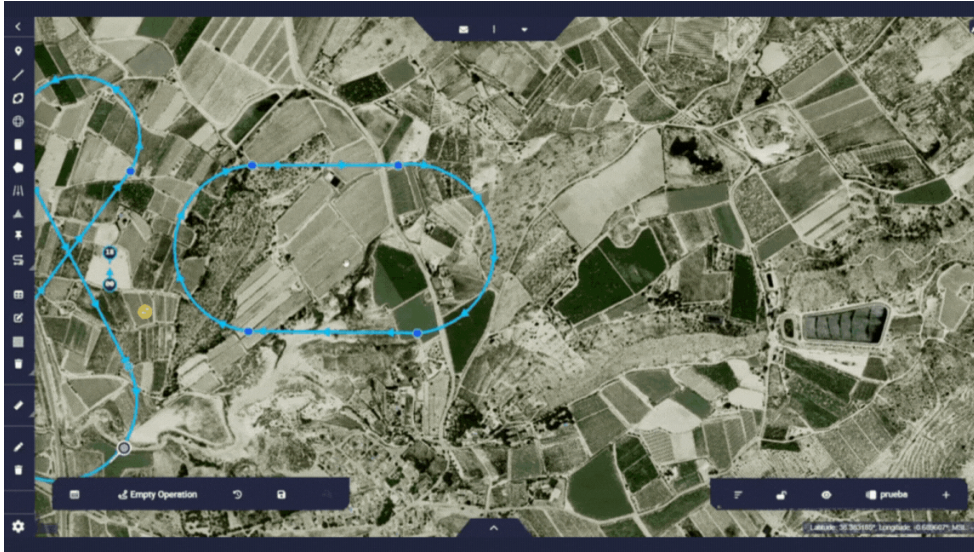

Operation 3 - Set Patch A

Mark B

Follow the steps below to define the **Mark B**:

1. In the 1x PDI Builder app → go to UI menu → Operation elements panel → **Marks tab**.

Define the mark by setting a **custom name**.

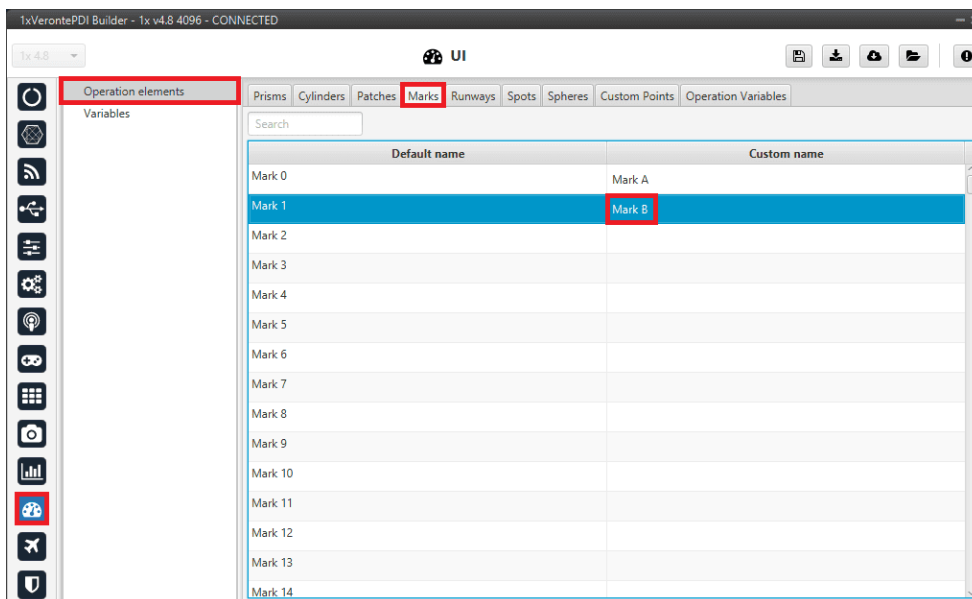

Operation 3 - Mark B definition

2. In the 1x PDI Builder app → go to Automations menu → **New automation**.

An automation will be created so that, once this mark is achieved, the aircraft begins its **approach** phase.

- To configure this event, select the **Route** type and choose the **mark achieved** option.

For more information, visit the [Route - Events](#) section of the **1x PDI Builder** user manual.

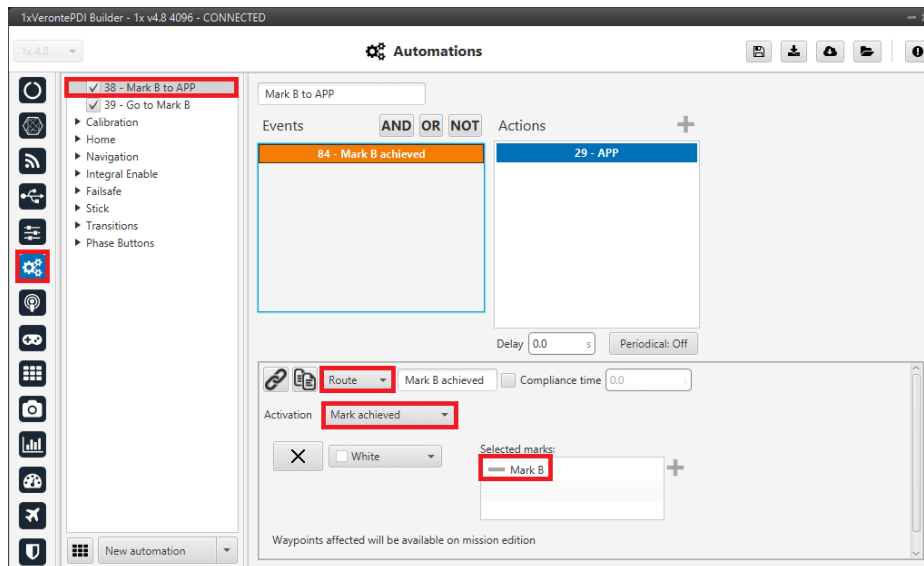

Operation 3 - Mark B event

- To define the action triggered by the event, configure a **Phase** action and select the phase to change, in this case to the Approach phase.

For more information, visit the [Phase - Actions](#) section of the **1x PDI Builder** user manual.

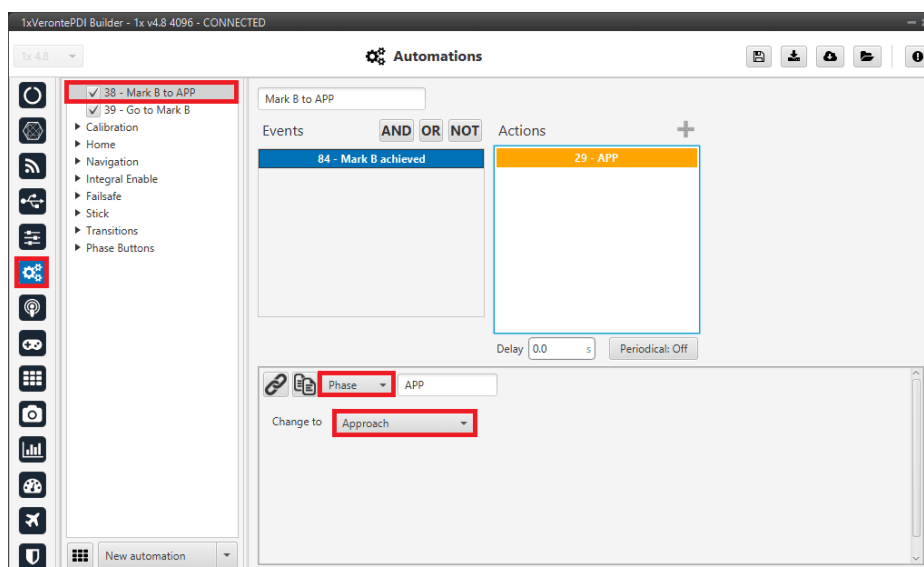

Operation 3 - Mark B action

3. Save the configuration so that the changes made will appear in **Veronte Ops**.

4. Create the mark in **Veronte Ops**. For this:

In Veronte Ops → go to Mission Toolbar → **Mark**.

Click on the desired patch to place a mark on the route.

Then, with the **Edit Mission** option



of the Mission Toolbar, users

can more precisely place the mark.

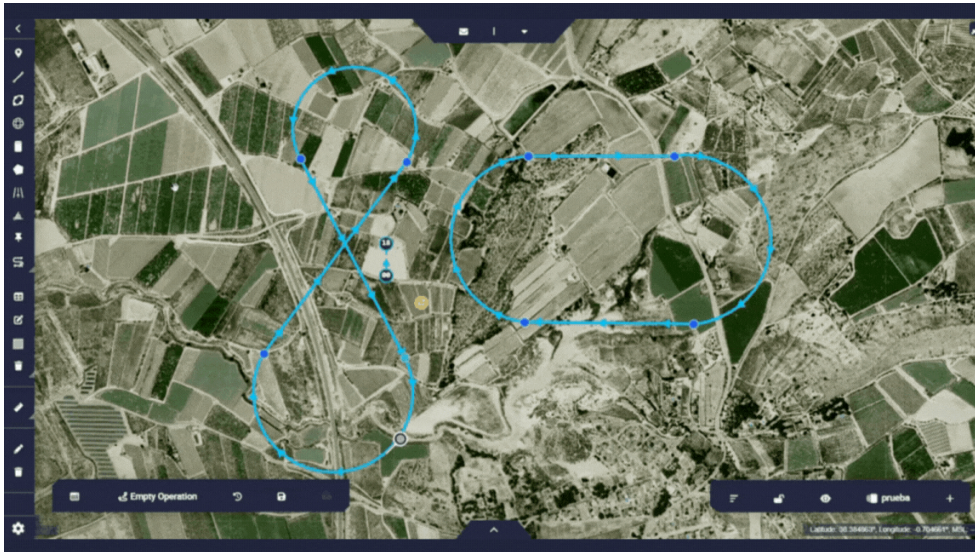

Operation 3 - Mark B creation

5. Go to Operation Panel → Customize → **Marks**.

Link the mark defined in the **1x PDI Builder** configuration with the just created mark.



Operation 3 - Set Mark B

Workspace

The creation of a customized workspace allows the user to display the desired information to monitor the operation.



Workspace example

For more information, visit the [Workspace - Panels](#) section of the **Veronte Ops** user manual.

This section explains the **main** settings and **widgets** that are recommended be incorporated in the workspace to perform a **basic** flight.

Note

This workspace is designed specifically for the operation being performed, so not all the widgets explained below are necessarily useful for all operations.

Important

The widgets explained are not mandatory, each user should configure the workspace by adding the widgets that provide the best information about the operation.

Map

Veronte Ops offers the possibility to choose the map on which users want to operate. Users can choose from the maps provided by Veronte Ops or upload their own map.

In this operation, the **ESRI Satellite** map has been employed.

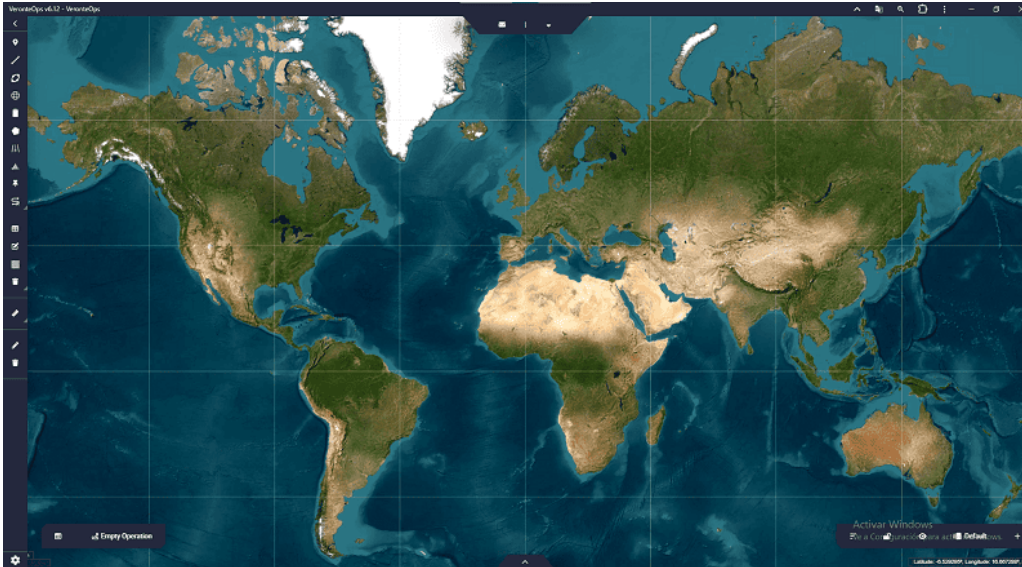

Workspace - Map

For more information, visit the [Map option - Workspace](#) section of the **Veronte Ops** user manual.

Main

Widgets from the "Main" category that have been used are presented below. For more information on these widgets, visit the [Main - Widgets](#) section of the **Veronte Ops** user manual.

- [Veronte Panel](#). This panel is the basic operator tool. It includes all basic commands (phase and action buttons) and information needed during a standard mission. These commands can be triggered with a single click, by sliding and/or automatically.

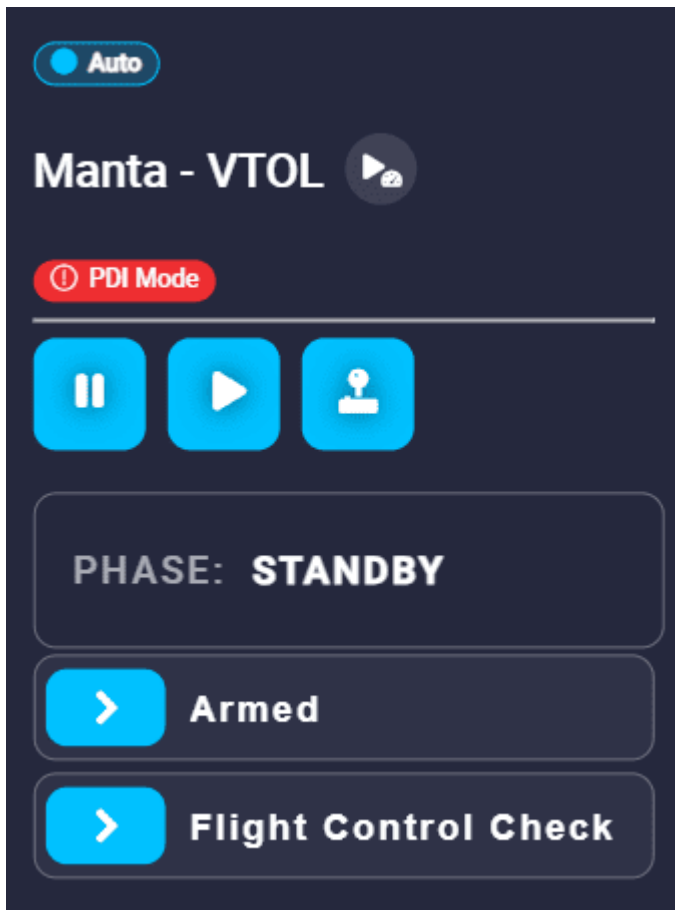

Workspace - Veronte Panel

Important

PDI Mode: This only appears if PDI Mode is configured in the **1x PDI Builder** app.

- [Checklist](#). This panel is used to make sure that some requirements have been met. This represents the checklist explained in [Checklist - 1x PDI Builder configuration](#) section.

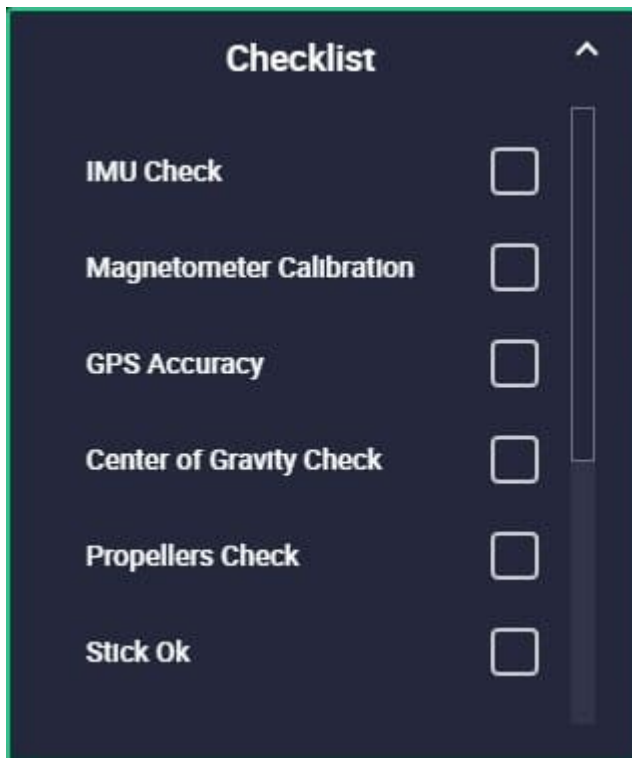

Workspace - Checklist

Important

It must be previously defined in the [Checklist panel](#) of the **Safety menu** of the **1x PDI Builder** app.

Displays

These widgets allow the user to display in real time the value of a variable.

For more information, visit the [Displays - Widgets](#) section of the **Veronte Ops** user manual.

- [Label](#). With labels the user can display the value of an **Integer variable**, **Real variable** or **Bit variable**. For a basic flight, the following labels are recommended:

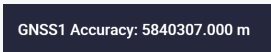
Variable	Label	Type
GNSS1 Accuracy		Real variable

Variable	Label	Type
GNSS2 Accuracy	GNSS2 Accuracy: 5842059.500 m	Real variable
AGL	AGL:21.83 m	Real variable
MSL	MSL:272.01 m	Real variable
Position Fix	Position Fix	Bit variable
System Error	System Error	Bit variable
Sensors Error	Sensors Error	Bit variable
Stick not detected	Stick Not Detected	Bit variable

It may also be interesting to display other variables in the labels:

- Stick-Pitch, Stick-Roll, Stick-Throttle, etc.
- Arc-Pitch, Arc-Roll, Arc-Throttle, Arc-Yaw
- Pitching (Q), Pitching (P), Rolling (Q), Rolling (P), etc
- Down Ground Velocity
- Static Pressure
- PDI error
- Power input

Charts

For more information, visit the [Charts - Widgets](#) section of the **Veronte Ops** user manual.

- **Chart.** Charts widgets allow the user to represent any variable of the system with respect to time. Thus, the user can visualize the evolution of that variable over time.



Workspace - Charts

For a **basic** flight, the following variables are recommended for charts:

Variable 1	Variable 2
	
Desired Roll	Roll
Desired Pitch	Pitch
Desired Yaw	Yaw
Desired Ground Speed (GS)	Ground Speed (GS)
Desired Front GV	Front GV
Desired Down GV	Down GV

Variable 1	Variable 2
	
Desired Lateral GV	Lateral GV
Desired Heading	Heading
Desired IAS	IAS
Desired FPA	Flight Path Angle (FPA)

It may also be interesting to plot the following variables:

- Control mix
- Roll rate, Pitch rate, Yaw rate
- P, Q, R (Angular Velocity)
- **Gauge.** Gauge widget is a data visualisation tool that can be used to show the progress of data or display data in ranges in a precise and compact area.

This widget can also be useful to represent variables such as **IAS** or **Motor RPM**:

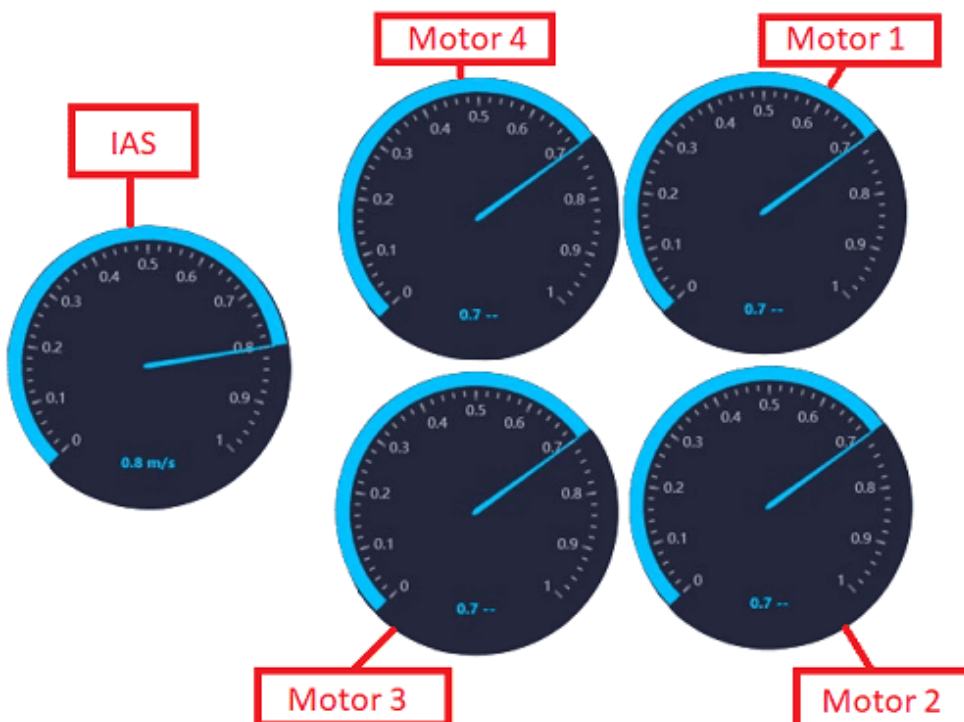

Workspace - Gauge

Flight instruments



Workspace - Flight instruments

For more information, visit the [Flight instruments - Widgets](#) section of the **Veronte Ops** user manual.

- **Attitude**. The attitude widget, commonly known as Primary Flight Display (PFD) or 'artificial horizon', represents graphically the attitude of the aircraft (**roll** and **pitch**).

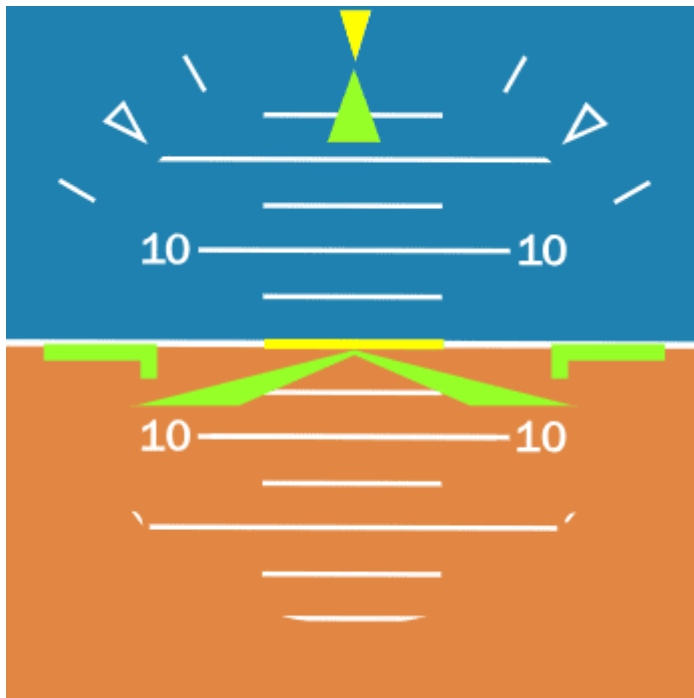

Workspace - Attitude

- [Heading](#). The heading widget, commonly known as **compass**, usually shows the platform's yaw relative to the magnetic north.



Workspace - Heading

Simulation

This section explains the steps to follow to simulate in **X-Plane 11** the operations defined in the [Operation](#) section.

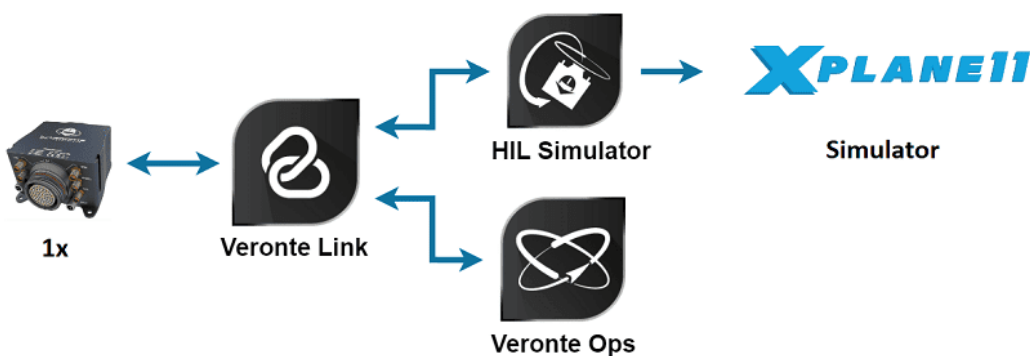

The simulation will be performed using the [HIL Simulator](#) tool.

⚠ Important

To configure X-Plane correctly, follow the steps of [X-Plane 11](#) section of the **HIL Simulator** user manual.



Once **X-Plane 11** has been correctly configured and the simulation has been started, in the following sections the user will be able to find the simulation of the operations:

- [Operation 1](#)
- [Operation 2](#)
- [Operation 3](#)

It also explains the [Stick configuration](#) to be performed in order to integrate and simulate the missions using a **stick**.

Operation 1

In this operation, the aircraft performs a mission consisting of a runway for the approach phase in Fixed-Wing (FW) flight configuration and a closed loop passing through all flight phases.

The performance of the aircraft in each of these phases and the transitions between phases that are triggered, are explained below.

Initial and Standby

In these flight phases all actuators are disabled. The guidance program does not send any commands to the actuators, so the charts do not show any data.

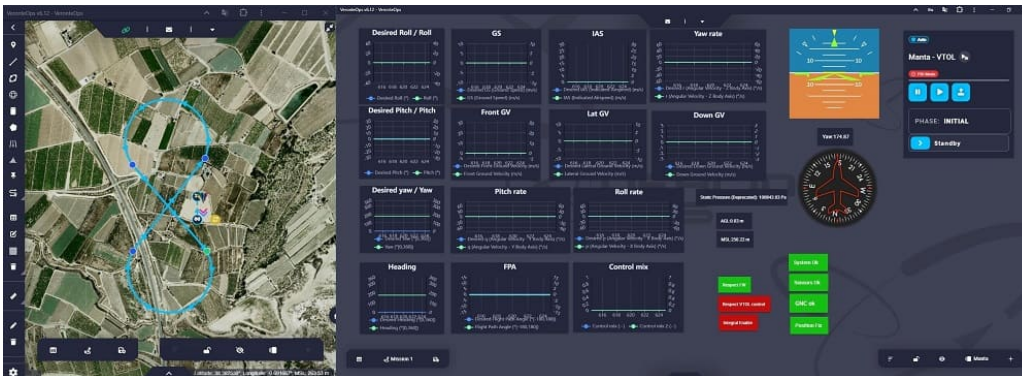

Operation 1 - Initial flight phase

Armed

In this flight phase, the four motors providing the thrust increase the RPM to **25%**. This increase, as explained, has been defined in the block programs.

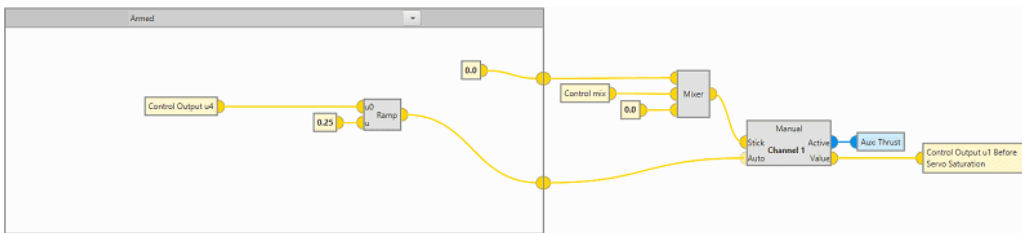

Operation 1 - Armed in Block Programs

This activation of the motors can be easily visualized with the gauges added to the workspace.

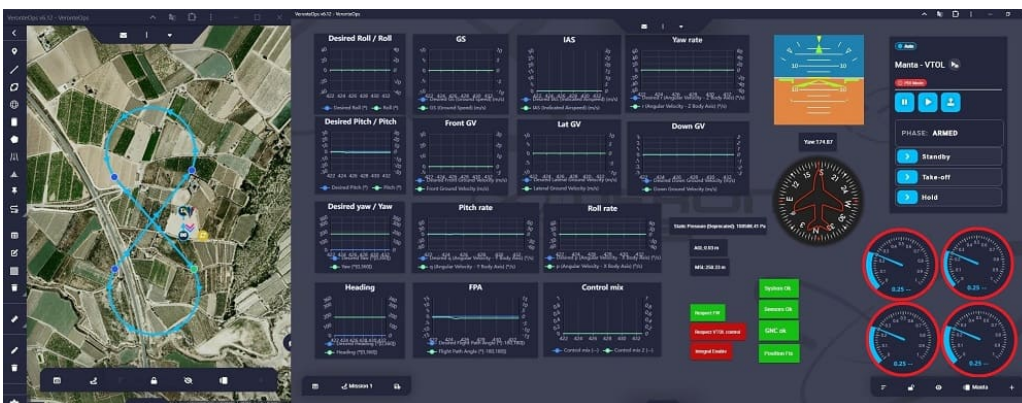

Operation 1 - Armed flight phase

Take-off

Since Take-off phase is performed with the aircraft in **quadcopter** flight configuration, the control variable is the Down Ground Velocity (DGV).

The aircraft performs a take-off at a DGV of **1.5 m/s**.

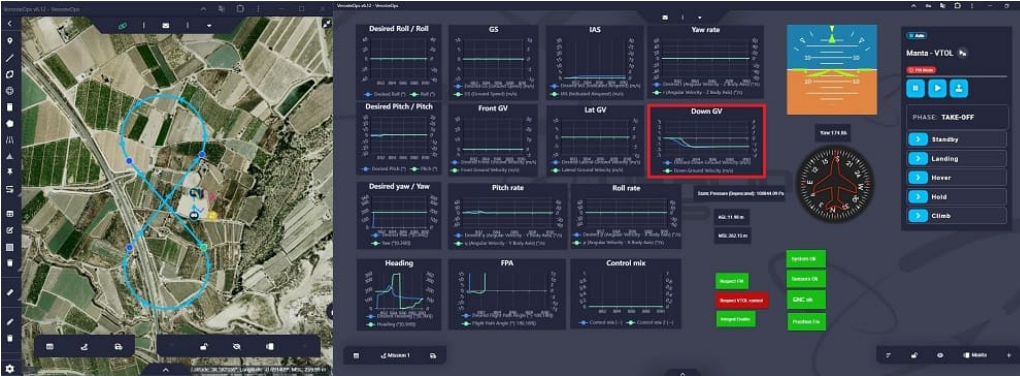

Operation 1 - Take-off flight phase

Once the aircraft reaches **20 meters** (AGL), Autopilot 1x transitions to the **Hover** flight phase. This automation has been explained in the [Automations - 1x PDI Builder configuration](#) section.

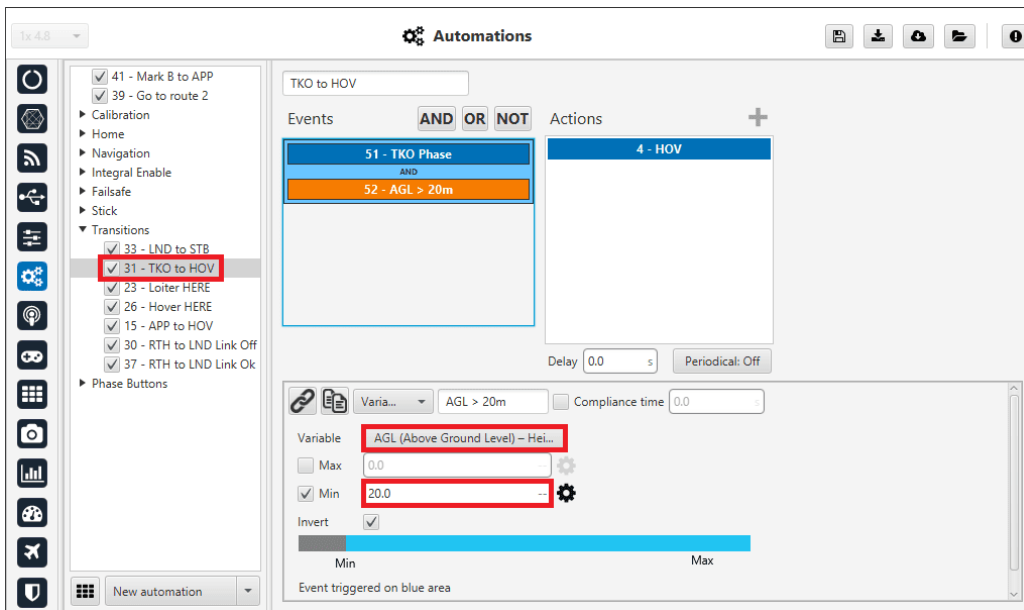

Operation 1 - TKO to HOV automation

Hover

In this flight phase, Veronte Autopilot 1x stabilizes the 3D position, so the aircraft attitude control variables (Desired Pitch, Desired Roll, Desired Yaw), Desired Down Ground Speed and Desired IAS variables are **null and constant**.



Operation 1 - Hover flight phase

Cruise

When the operator commands Autopilot 1x to switch to the **Cruise** flight phase, a path to the mission point defined as **Start Route** is automatically generated.

To switch from Hover to Cruise, the aircraft changes the flight configuration from quadcopter to **FW**. This change can be represented by plotting the Control mix variable on a chart.

In this workspace, two labels have been added to show the behavior of the PID controllers for quadcopter and FW control:



In this flight phase, the control variables for **attitude** are: Desired Pitch, Desired Roll and Desired Yaw. And for **aircraft speed**: Front Ground Velocity and Lateral Ground Speed.



Operation 1 - Cruise flight phase

Veronte Ops allows users to visualize the aircraft trajectory during the mission. For more information, visit the [Platform icon - Veronte Ops configuration](#) of the **Veronte Ops** user manual.



Operation 1 - Trajectory in cruise flight phase

Note

In this operation, the aircraft will remain in the Cruise phase until a phase change is commanded.

Loiter

Note

Loiter phase can only be entered manually by the user from its phase button on the Veronte Panel.

When the operator commands Autopilot 1x to switch to Loiter flight phase, a circular path is generated around a point, which is the current position where the aircraft is at that moment.

Note

The aircraft follows this route until another phase change command is given.



Operation 1 - Loiter flight phase

The path configuration for Loiter is defined in the following automation:

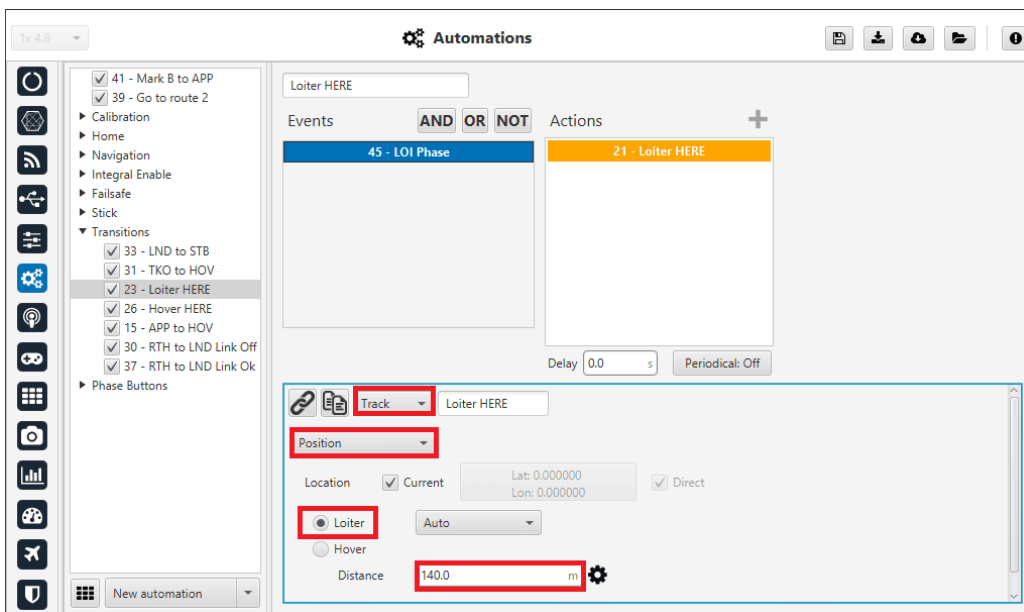

Operation 1 - Loiter here automation

For more information, visit the [Automations - 1x Air configuration](#) section of this manual.

Hold

In this flight phase, the aircraft attitude and vertical velocity are stabilized. The control variables Desired Pitch, Desired Roll, Desired Yaw and Desired Down Ground Velocity are **null and constant**.

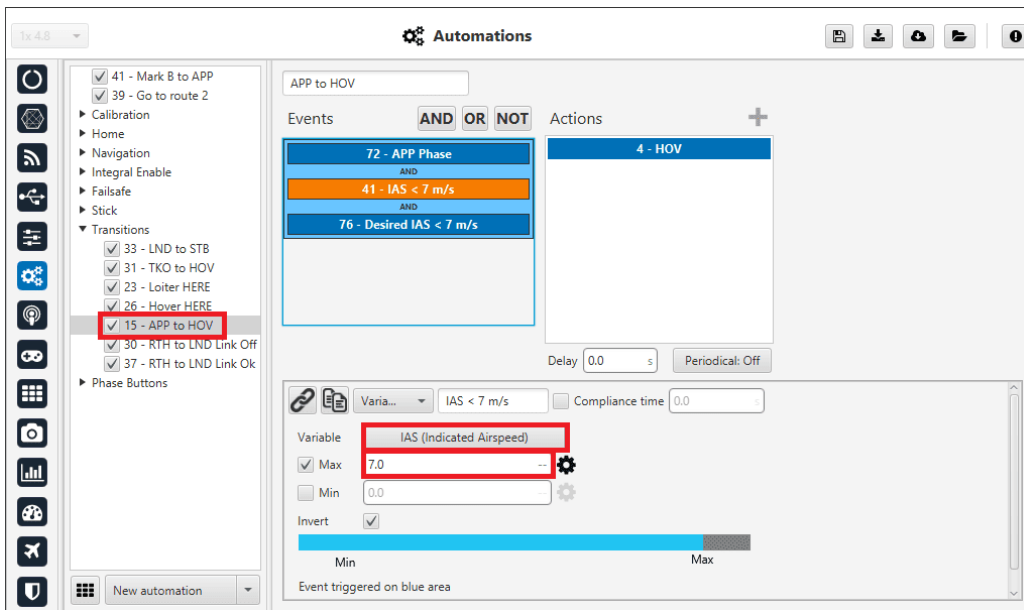

Operation 1 - APP to HOV automation

For more information, visit the [Automations - 1x Air configuration](#) section of this manual.

Landing

The control variable for the Landing phase is the Desired Down Ground Velocity:

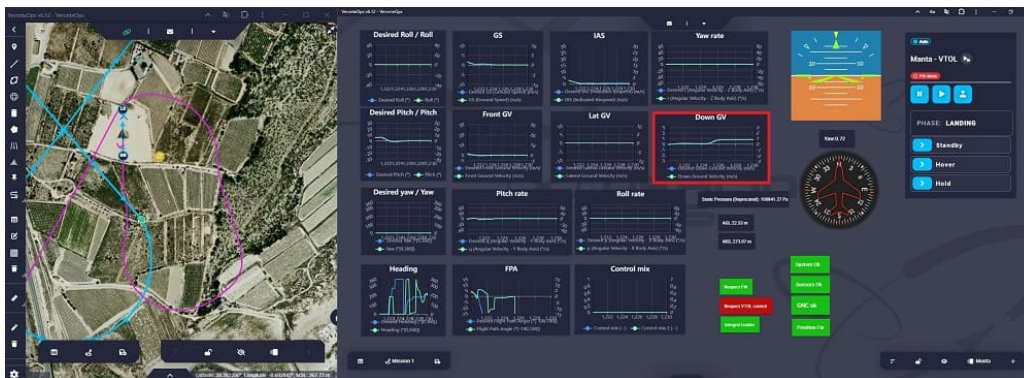

Operation 1 - Landing flight phase

At the end of the Landing phase, the aircraft enters the **Standby** phase.

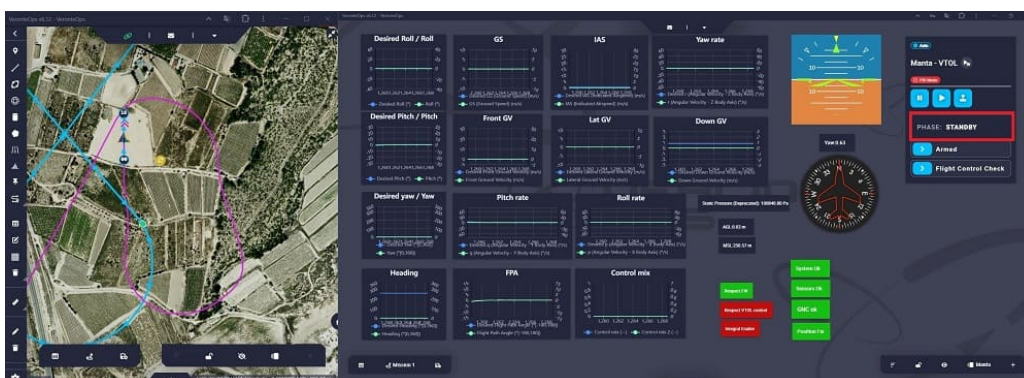

Operation 1 - Landing to Standby transition

The automation that allows the transition from the **Landing** phase to the **Standby** phase has been defined in the [1x PDI Builder configuration](#):

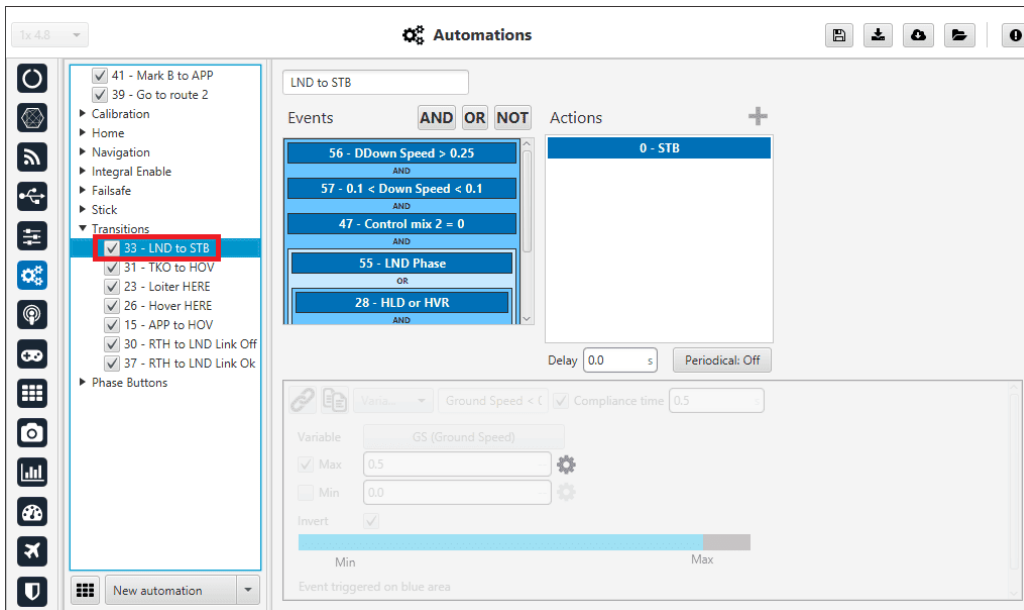

Operation 1 - LND to STB automation

For more information, visit the [Automations - 1x Air configuration](#) section of this manual.

Return to Home

When the aircraft enters the Return to Home phase, the guidance program automatically generates a path to the point defined as **Home**.



Operation 1 - Return to Home flight phase

This flight phase ends at the **Home** point, where the aircraft passes to the **Landing** flight phase.

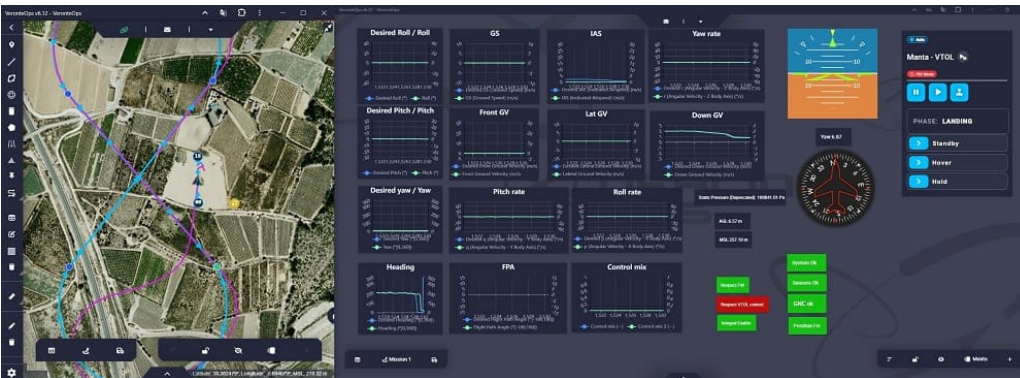

Operation 1 - Return to Home to Landing transition

The automation that enables the transition from the **Return to Home** phase to the **Landing** phase has been defined in the [1x PDI Builder configuration](#):

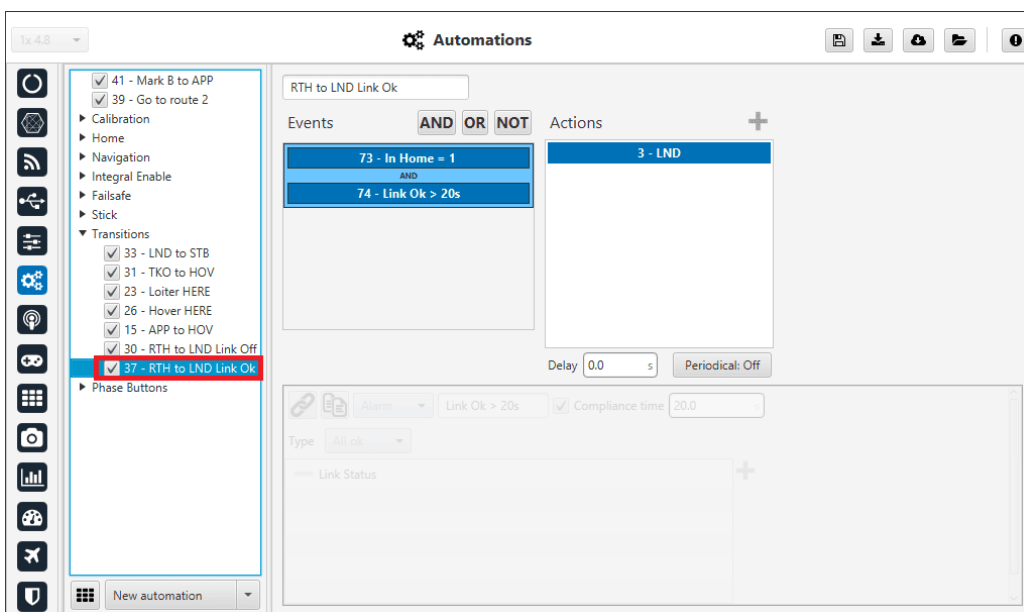

Operation 1 - RTH to LND automation

For more information, visit the [Automations - 1x Air configuration](#) section of this manual.

Operation 2

Operation 2 is the same as [Operation 1](#) but with the addition of two areas that trigger an action:

- **Area 1:** Change to Return to Home flight phase.
- **Area 2:** Obstacle.

The actions triggered in this operation will be performed while the aircraft is flying in the Cruise phase. This phase begins at the point defined as **Start**

Route, therefore, following the route orientation, the aircraft will pass firstly through area 2 and secondly through area 1.

Note

The transitions between phases and basic actions to perform the operation have already been explained in [Operation 1](#), so only the parts specific to Operation 2 are detailed in this section.

Area 2

As area 2 has been defined as an **obstacle**, the guidance program will prevent the aircraft from flying **within** this area by creating an alternative trajectory:



Operation 2 - Obstacle avoidance trajectory

The Maximum deceleration for obstacle avoidance is defined in the [Envelope block - Guidance program](#) of the 1x PDI Builder configuration.

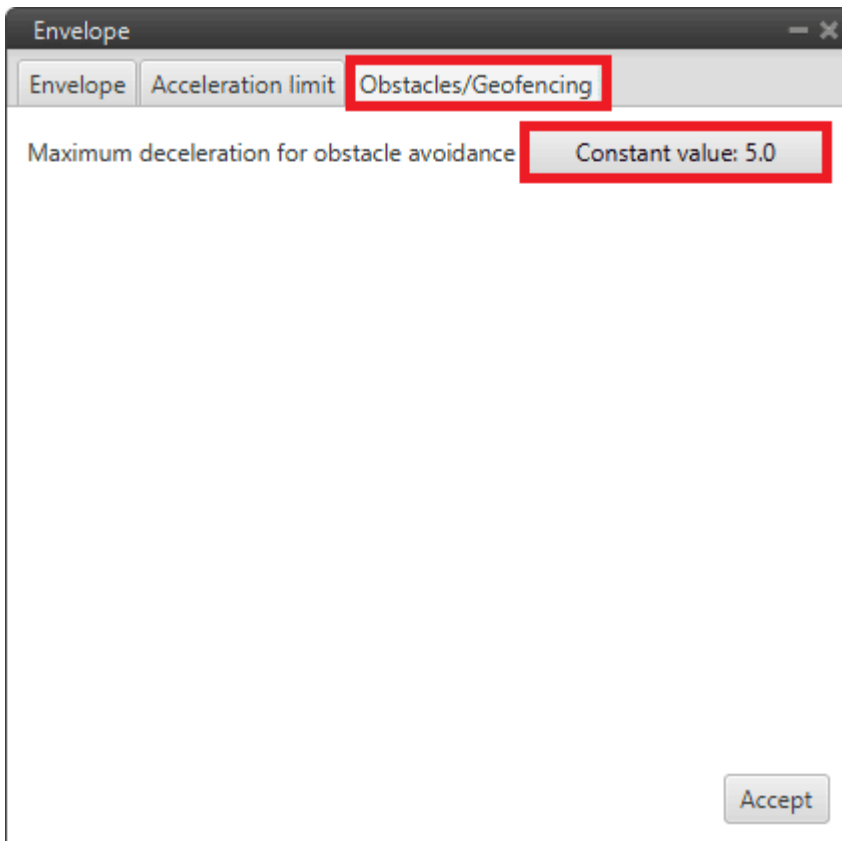

Operation 2 - Envelope block

Area 1

Area 1 is linked to a phase change automation that is activated when the aircraft flies **inside** it. **Autopilot 1x** will switch to the **Return Home** phase of flight.



Operation 2 - Area 1 to RTH

Operation 3

In this operation, two missions have been defined, each consisting of a closed loop and a mark:

- **Mark A:** Triggers the **Go To** action to Mission 2.

- **Mark B:** Triggers the action to change to the **Approach** flight phase.

Note

The transitions between phases and basic actions to perform the operation have already been explained in [Operation 1](#), so only the aspects specific to Operation 3 are detailed in this section.

Mark A to Mission 2

The cruise phase begins at the point defined as the **Start Route**.

When the aircraft flies through the first mission and reaches **Mark A**, the action to **go to** the second mission is triggered. For this purpose, the guidance program generates a path between the current location of Autopilot 1x (i.e. the point where the mark is placed) and the selected **patch**:



Operation 3 - Mark A to Patch A

When the aircraft arrives at the selected patch, it will continue flying Mission 2.

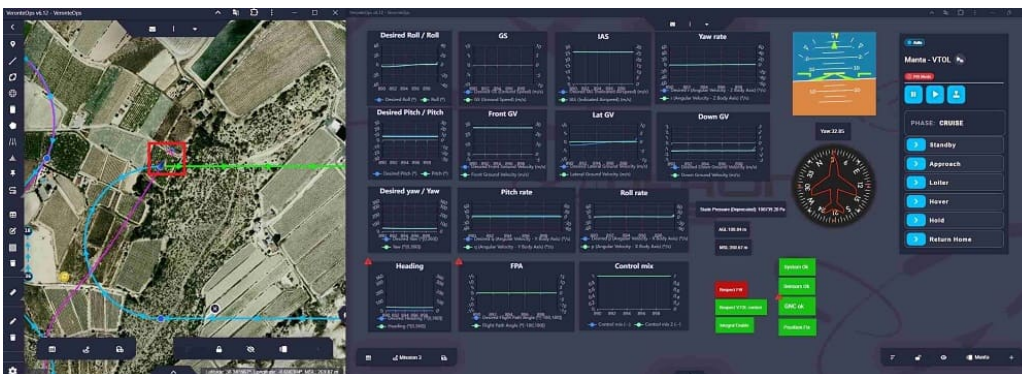

Operation 3 - Mission 2

Mark B to Approach phase

When the aircraft reaches the **Mark B** in the second mission, a phase change to the **approach** phase is triggered. Consequently, the guidance program will automatically generate a route to the **runway**.



Operation 3 - Mark B to Approach phase

Stick

When performing HIL simulations, the user only uses one Autopilot 1x. Follow the steps below to configure the stick for this case:

1. Go to Input/Output menu → **Digital Input panel.**
 - Producer: **CAP 0**
 - Enabled
 - Select the pin to which the transmitter is connected, in this case EQEP_A
 - Edge detection: First rising edge
 - Consumer: **PPM 0**

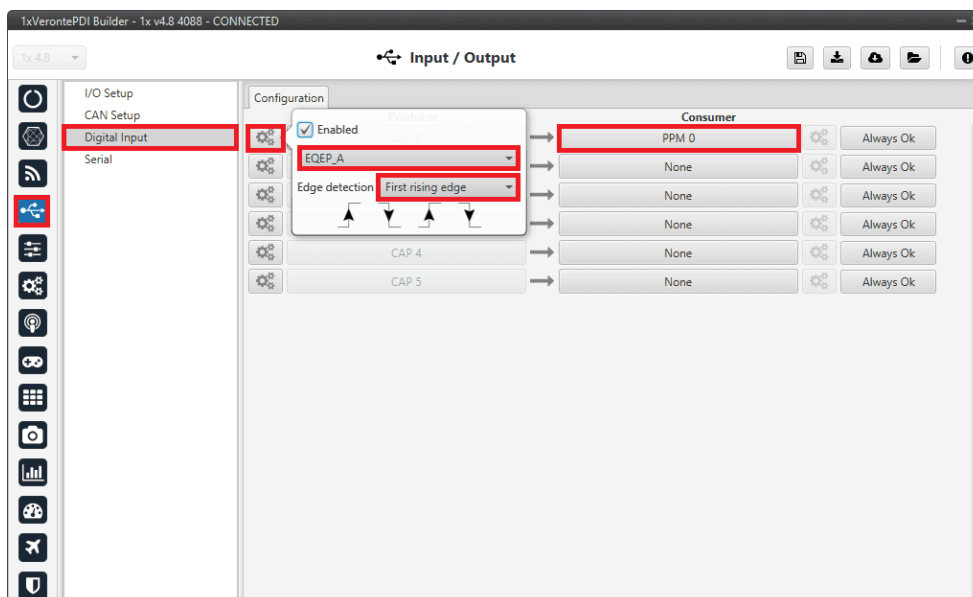

Simulation - Digital Input configuration

- Go to Connections menu → **GPIO panel.**

Verify that the pin to which the transmitter is connected, in this case GPIO 16 (i.e., EQEP A), is set as **input**.

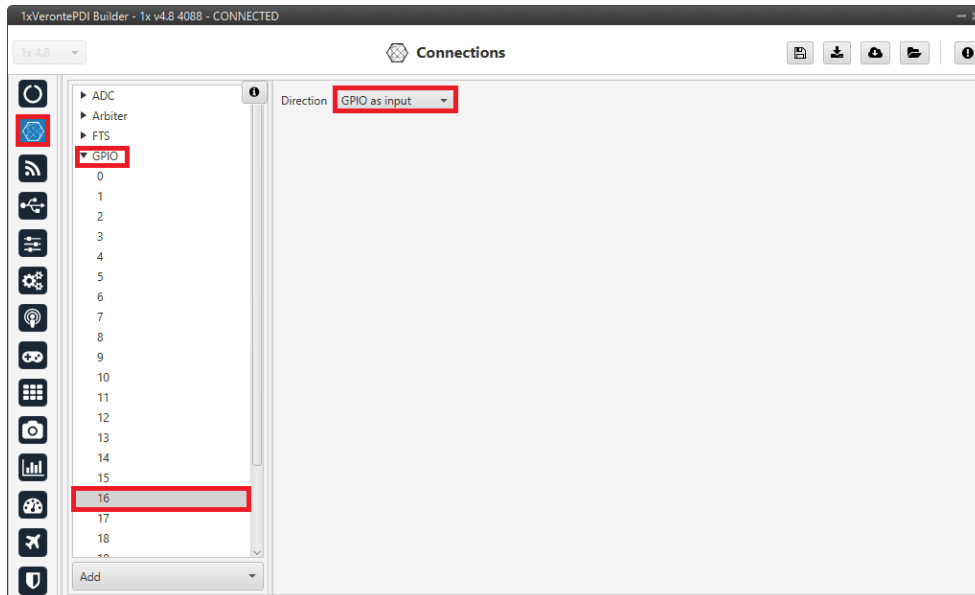

Simulation - GPIO configuration

- Go to Stick menu → Transmitter 0 panel → **PPM tab.**

Select the brand of transmitter that applies.

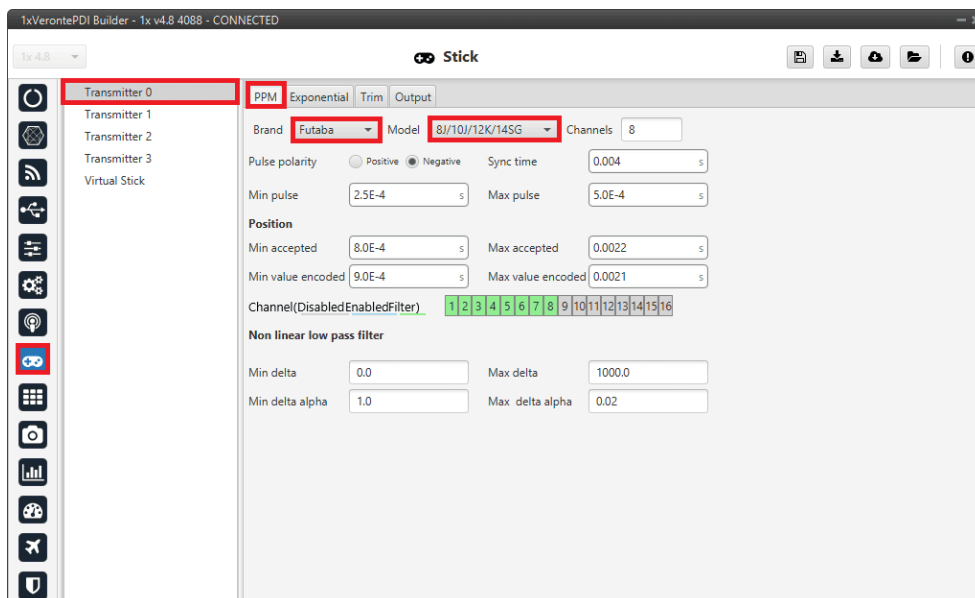

Simulation - PPM configuration

- Go to Stick menu → Transmitter 0 panel → **Output tab.**

Just click on **Enable**.

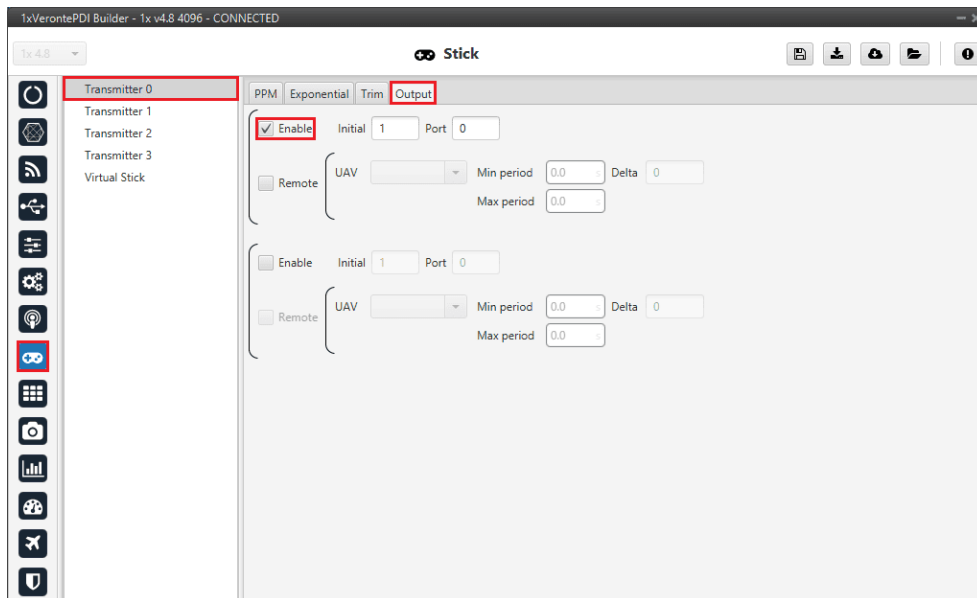

Simulation - Output configuration

5. Go to Block Programs menu → **Stick program** → Double click on the **Stick block** → **Edit sources**.

Note

This is the **Stick program** explained in the **1x Air configuration** section of this manual.

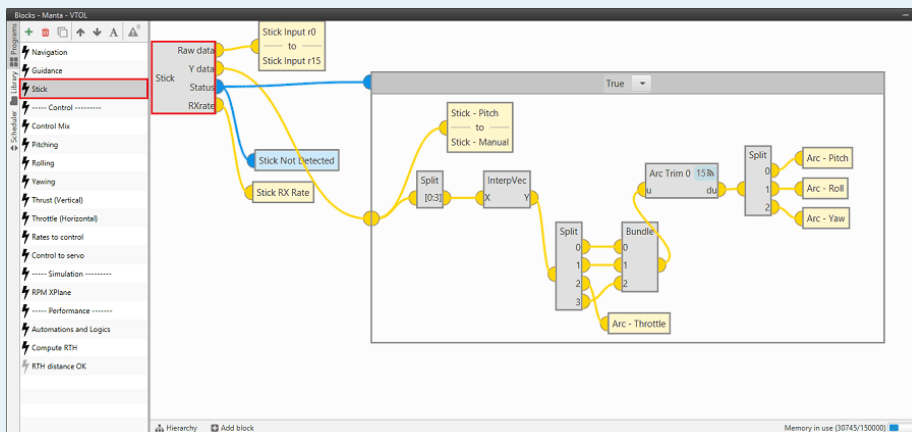

Stick program

Input the **Local address** to receive the stick information from that source and put it as the **highest priority** in the priority table. We recommend a Time Out of **0.4 s**.

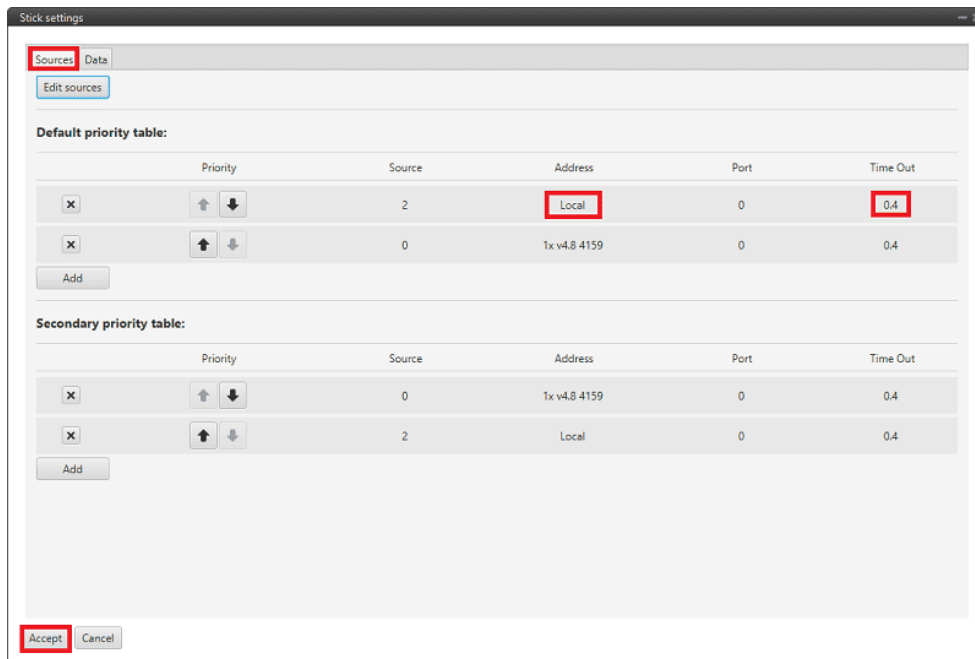

Simulation - Stick block configuration

1x GCS configuration

This section defines the GCS (Ground Control Station) configuration to be used to communicate with the Veronte Autopilot 1x on board the aircraft.

i Note

In this case, an Autopilot 1x is used as GCS.

All Kinds of Vehicle

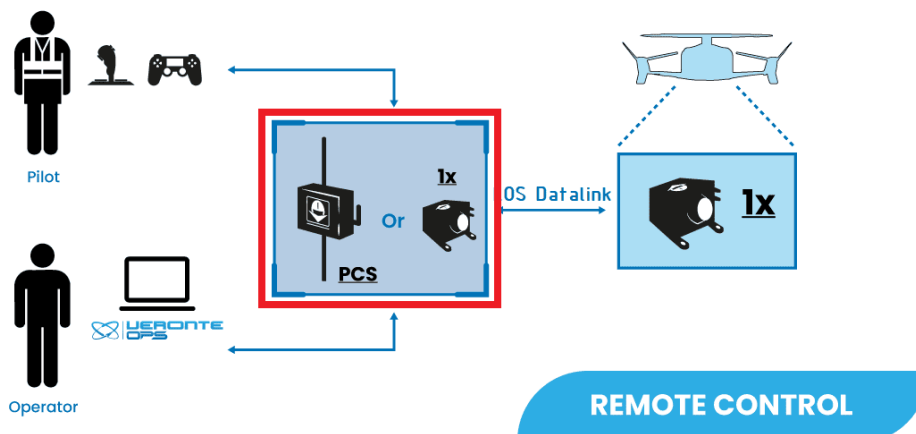

To configure the 1x Ground unit, the user must download the **Veronte Ground** template available in the **1x PDI Builder** software. To do so, follow the steps below:

1. Connect the Autopilot 1x to be configured as Veronte Ground to the PC, in this case, the connection is made via **USB**. Users can refer to the [Basic connection for operation - Quick Start](#) section of the **1x Hardware Manual** for instructions on how to make this connection.
2. Check in **Veronte Link** that the Autopilot 1x is in **ready** status.

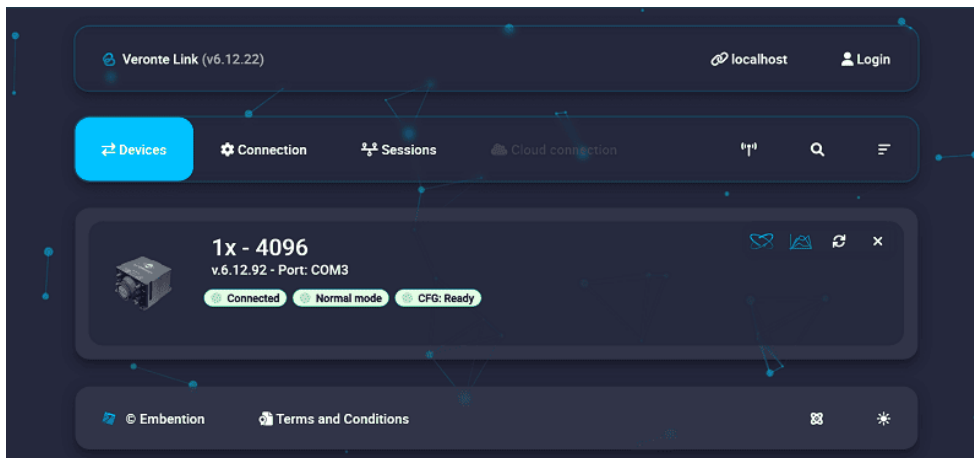

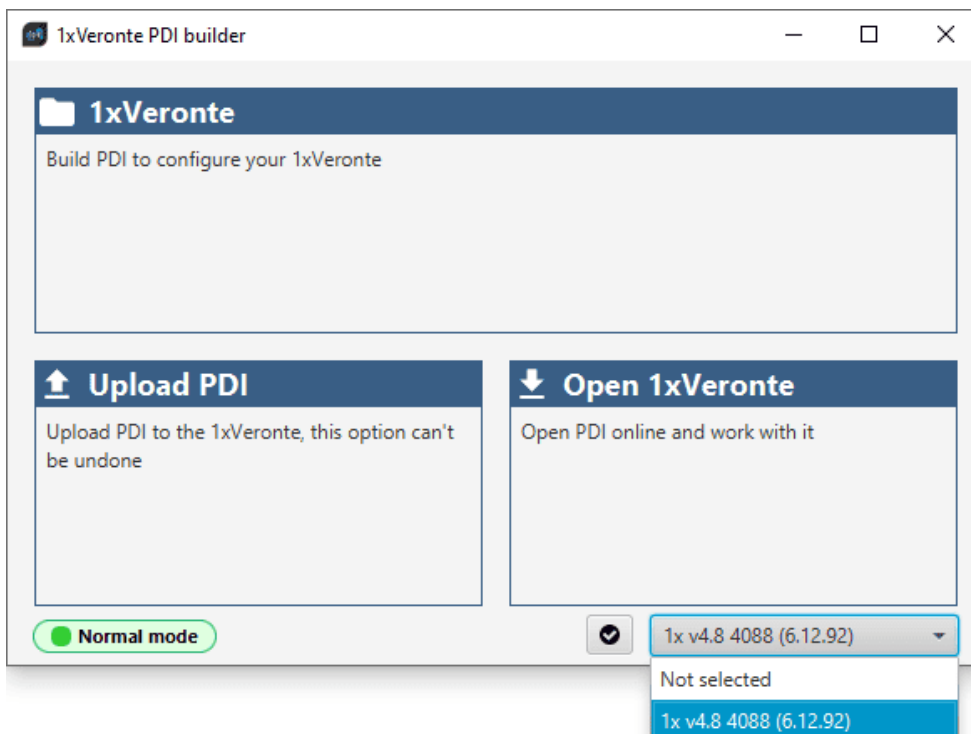

For a detailed explanation of how to set up this connection, please refer to the [Serial connection - Integration examples](#) section of the **Veronte Link** user manual.

3. Open the **1x PDI Builder** app and select the Autopilot 1x:

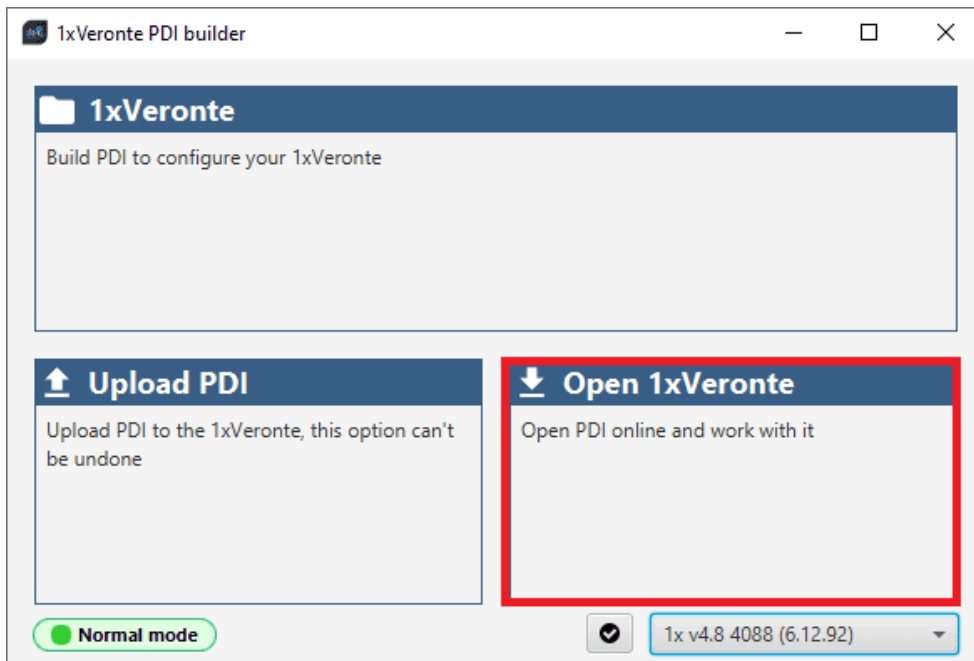

4. Select the **Open 1xVeronte** option to access the configuration of the connected unit:



5. Click on the  button in the menu bar to access the Veronte **templates**:

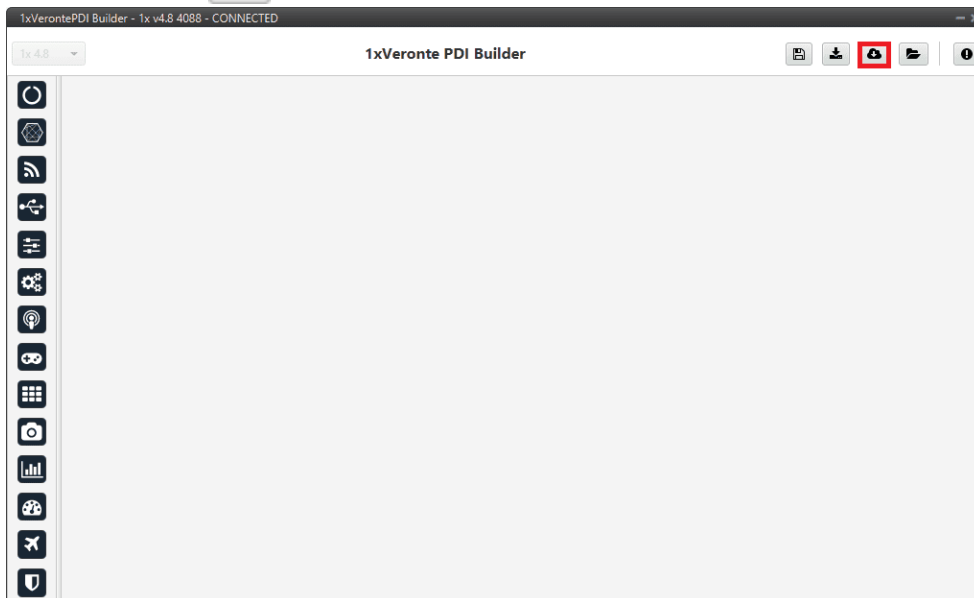

6. Select the **Veronte Ground** template and click **import**:

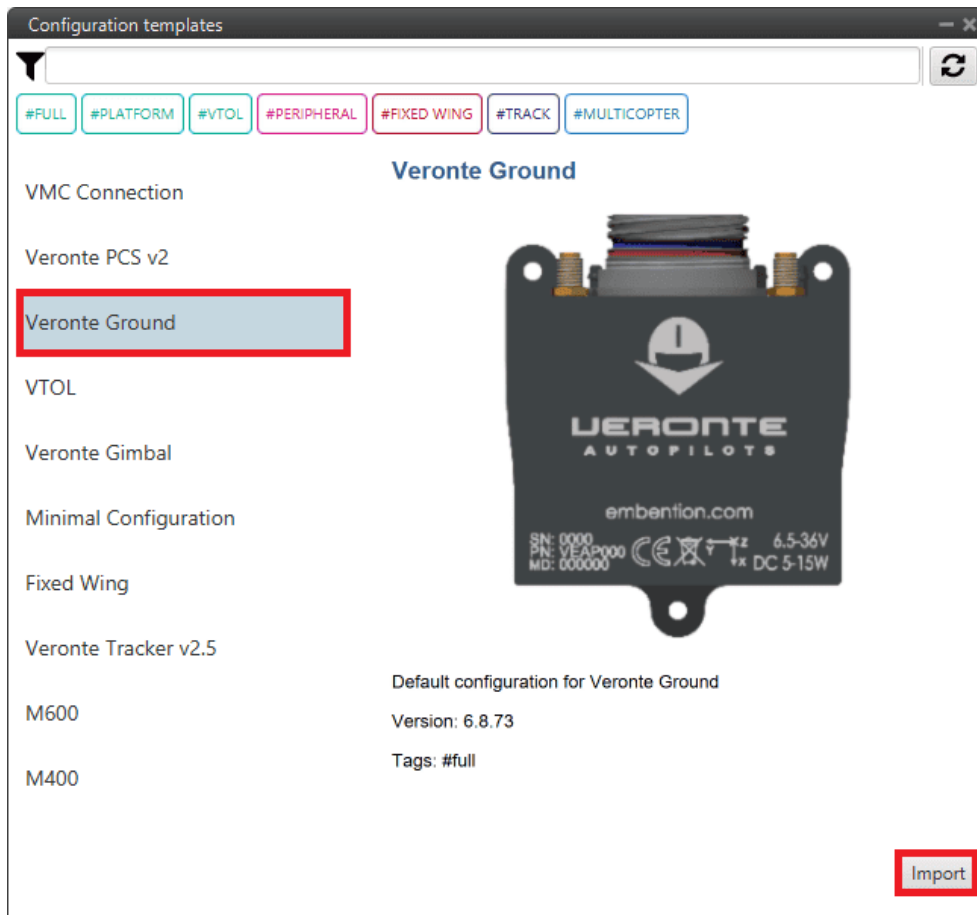

7. Click the  button to load the downloaded template into Autopilot 1x.

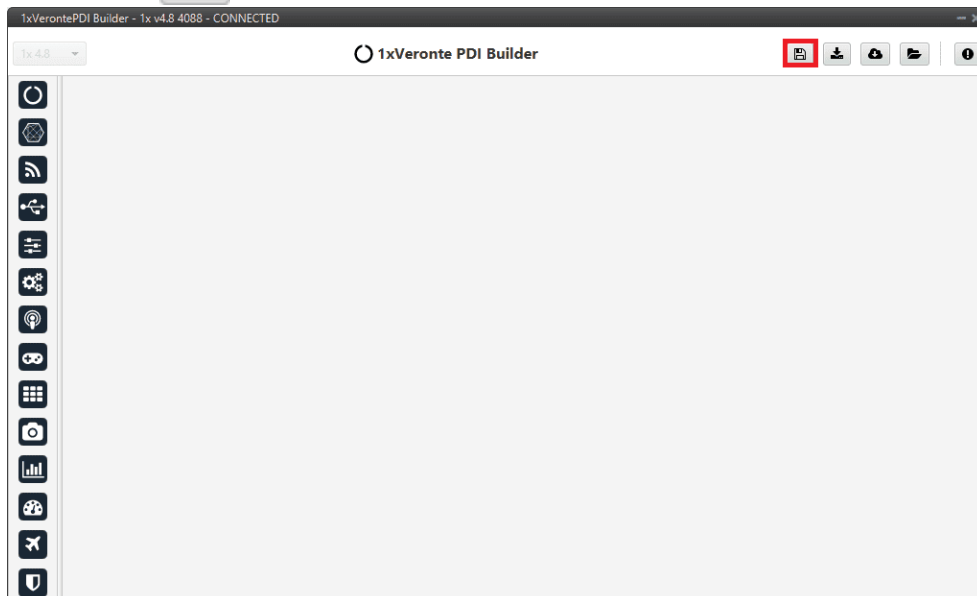

⚠ Important

In order to save the configuration, Veronte Autopilot 1x must enter in maintenance mode. Then, after saving any changes, Autopilot 1x will RESET and 1x PDI Builder software will consequently close. For more information on this, visit the [Configuration](#) section of the **1x PDI Builder** user manual.

Once the **Veronte Ground** template has been downloaded and uploaded into the Autopilot 1x, follow the steps in the next section, [Air-GCS connection](#), to set up the connection between GCS and the on-board Autopilot 1x.

Air-GCS connection

This section defines how to configure the air-ground Autopilots 1x to communicate with each other and send the desired information.

All Kinds of Vehicle

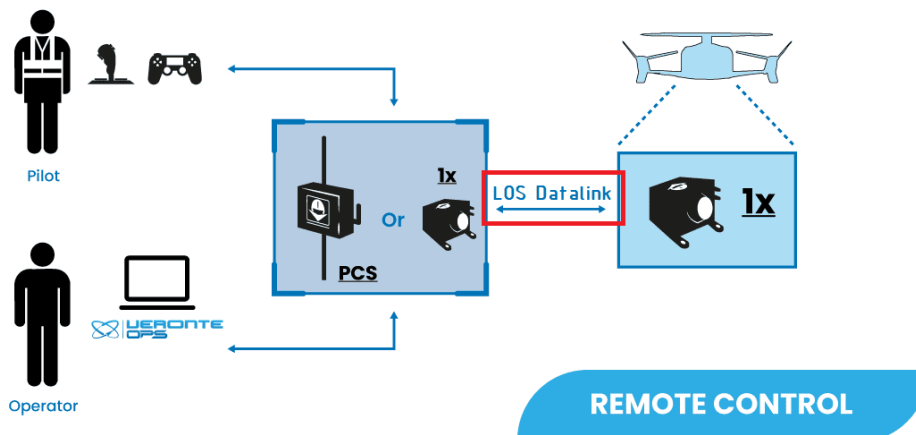

- **Communication.** This section defines the different configurations that must be performed to ensure communication between Autopilots 1x.
- **Stick.** This section defines the configuration of the Autopilots 1x to receive the commands sent by the Stick.

Communication

This section explains the steps to follow to set up **radio communication** between Autopilots 1x. Follow the steps below:

GND unit configuration

1. Go to Input/Output menu → **I/O Setup panel.**

The following connections between **producers** and **consumers** must be configured here:

- **USB** ↔ **Commgr port 0.**
- **Veronte LOS** ↔ **Commgr port 1.**
- **Commgr port 0** ↔ **USB.**
- **Commgr port 1** ↔ **Veronte LOS.**

Note

It is not necessary to use these particular COM Manager ports, however, the connections between these producer and consumer must be **bidirectional**.

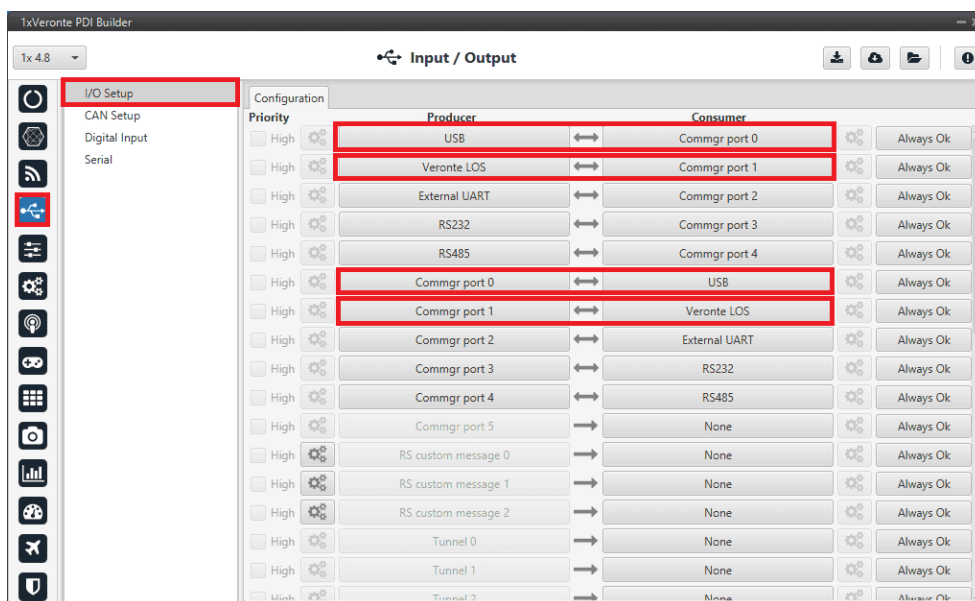

Ground unit - Input/Output configuration

Air unit configuration

1. Go to Input/Output menu → **I/O Setup panel.**

Configure the following connections between **producers** and **consumers**:

- **Veronte LOS** ↔ **Commgr port 1.**
- **Commgr port 1** ↔ **Veronte LOS.**

i **Note**

It is not necessary to use these particular COM Manager ports, however, the connections between these producer and consumer must be **bidirectional**.

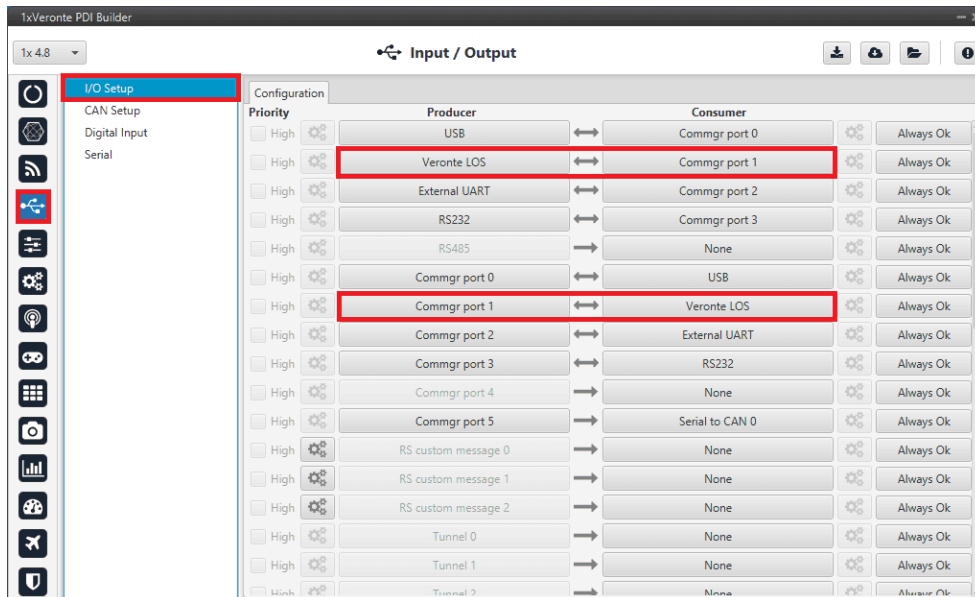

Air unit - Input/Output configuration

For more information, visit the [Input/Output - Configuration](#) section of the **1x PDI Builder** user manual.

GND-Air communication configuration

To establish a proper communication between the ground and air units, it is necessary to configure the **ports** menu of the **ground unit**.

1. Go to Communications menu → **Ports panel**.
2. In order to establish the connection between the PC and the 1x air unit thanks to the radio connection with the 1x ground, a routing of the communications must be made to the port to which the USB consumer is connected.

Therefore, set a routing of **Address 2** (address by which Autopilots 1x ground and air units **communicates with all Veronte applications**) through **Commgr port 0**.

This way, any messages that are received through a Commgr Port (i.e. through Veronte LOS) with **address 2**, will be re-routed through **Port 0**

(USB) and received by **Veronte Ops** software, including any messages generated by 1x ground unit itself.

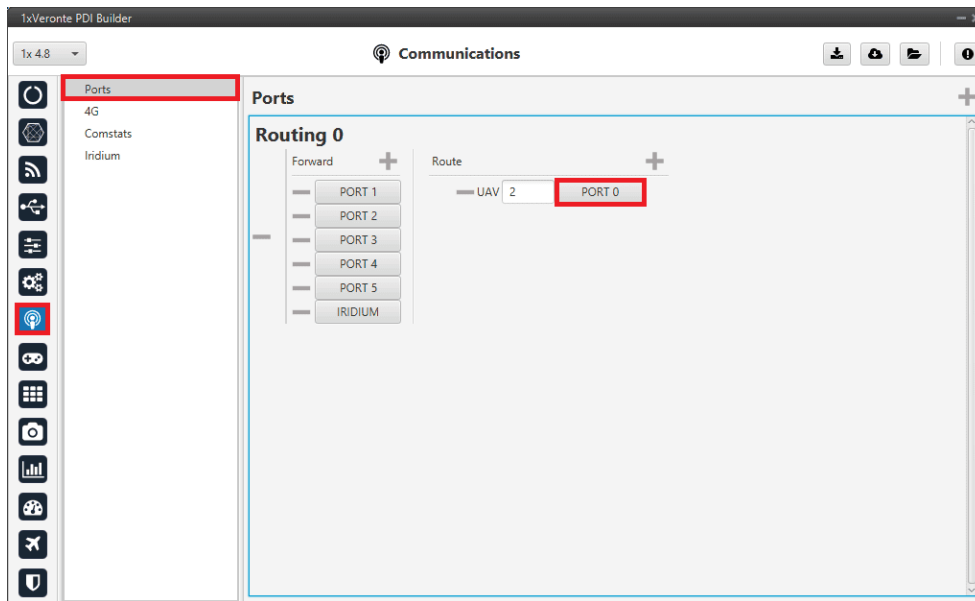

Ground unit - Routing configuration

For more information, please refer to the [Communication between Veronte Autopilots 1x - Integration examples](#) section of the **1x PDI Builder** user manual.

GND-Air data transmission configuration

To enable the data transmission between the ground and air units, the **telemetry** and **sniffer** menus must be configured, respectively.

A simple example of use between a ground unit and an air unit is shown below:

In the **1x ground unit**:

1. Go to Telemetry menu → Telemetry panel → **Data link to VApp tab** (for more information about this, see [Data vectors - Telemetry](#) section of **1x PDI Builder** user manual).
2. Add the variables: Absolute: UAV position, Yaw, Pitch and Roll.
3. Set a **Frequency**, it is recommended to set it to **10 Hz**.
4. On **Address**, point to the **1x air unit** (it is needed to have both units connected through the radio in order to be able to see them on the menu).

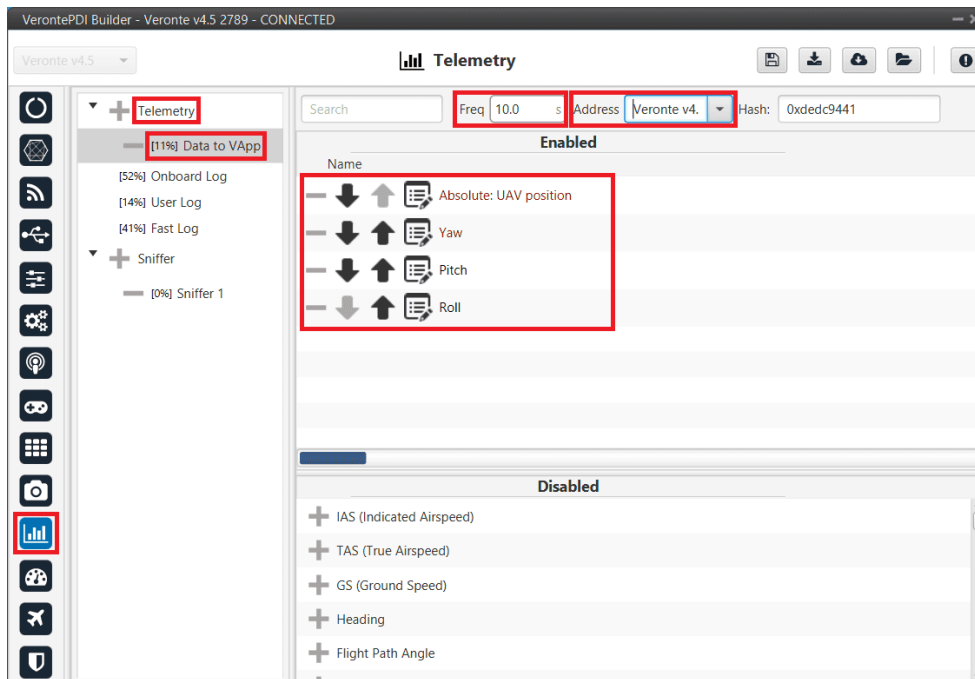

1x ground unit - Telemetry

For the **1x air** unit:

1. Go to Telemetry menu → **Sniffer panel** (for more information about this, see [Sniffer - Telemetry](#) section of **1x PDI Builder** user manual).
2. Add a new Sniffer.
3. Configure the same **variables** (keeping the **same order**) than in the ground unit.
4. On **Address**, point to the **1x ground unit**.
5. In the gear next to it, configure the 4 incoming variables as System Variables: assign UAV Position to **Moving Object** and the 3 variables from attitude to 3 different **User Variables** (keeping the **same order** as well).

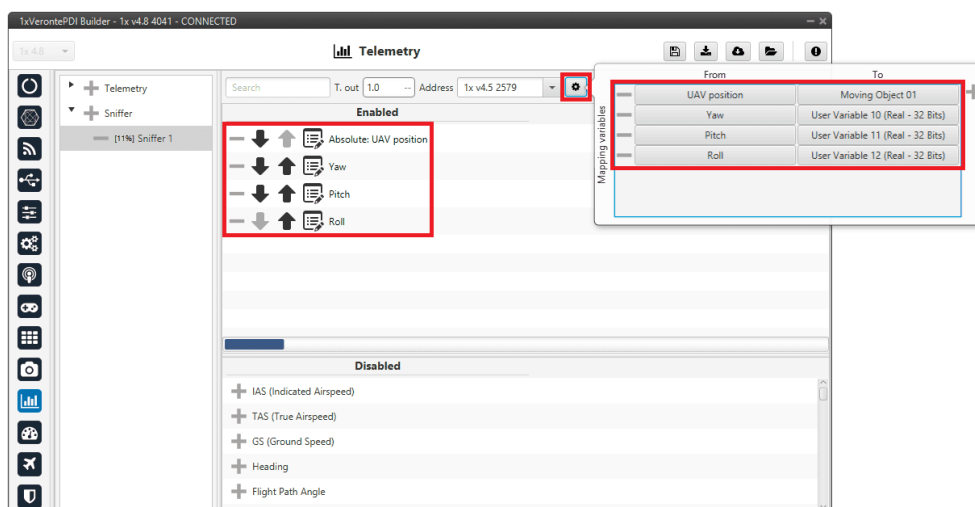

1x air unit - Sniffer

Radio pairing

In order to establish communication between the two units, it is necessary that the **radios** of both devices are **paired**. For this operation, there is an internal **Digi** radio in both Veronte Autopilots 1x.

Follow the steps described in the [Digi internal radio - Integration examples](#) section of the **1x PDI Builder** user manual, for both units, GND and air.

If everything went well, the user will be able to see the air unit in both **Veronte Link** and **Veronte Ops** by **physically connecting only the ground unit**.

i Note

Autopilot 1x configured as the GND unit has address **4086** and the air unit has address **4085**.

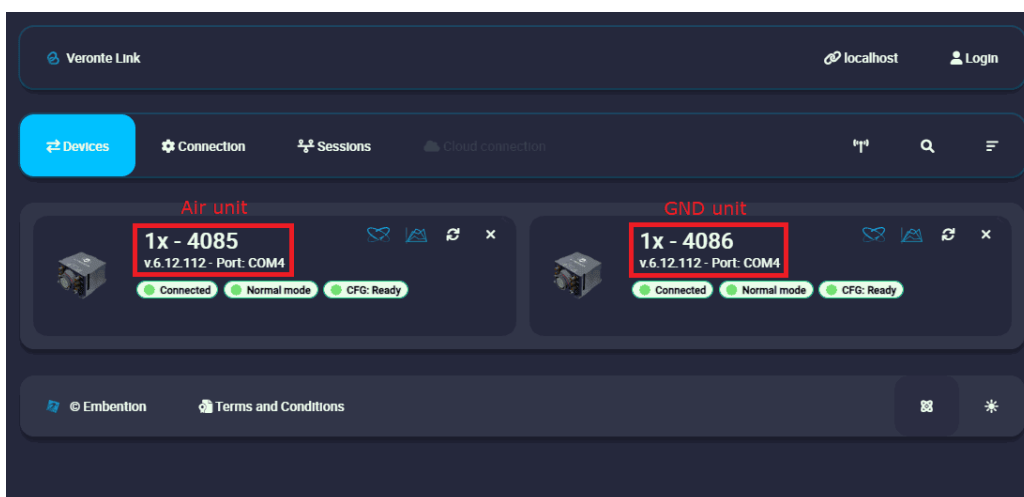

Radio pairing - Veronte Link

Ground unit

1. Go to Input/Output menu → **Digital Input panel.**

- Producer: **CAP 0**
 - Enabled
 - Select the pin to which the transmitter is connected, in this case EQEP_A
 - Edge detection: First rising edge
- Consumer: **PPM 0**

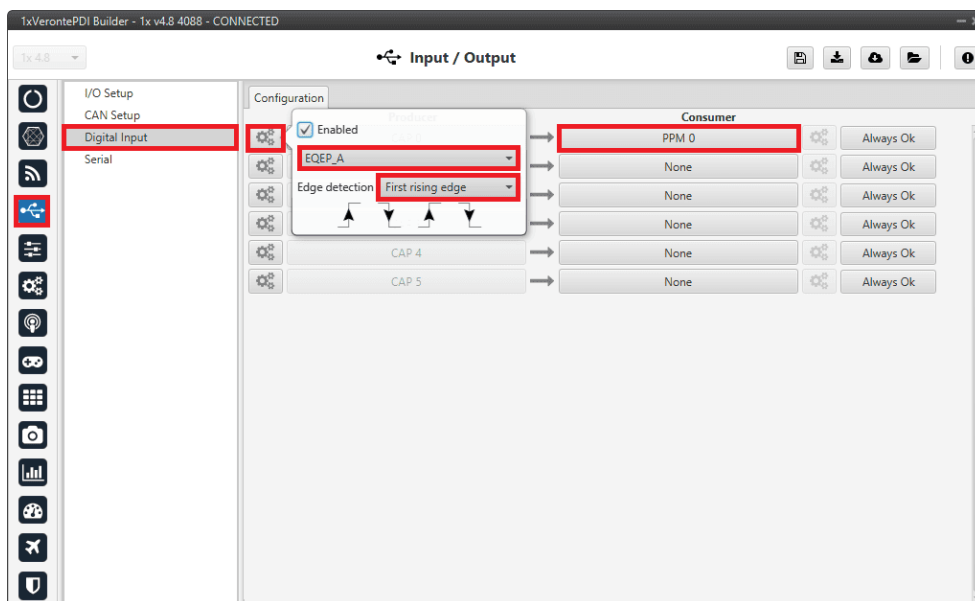

Ground unit - Digital Input configuration

2. Go to Connections menu → **GPIO panel.**

Verify that the pin to which the transmitter is connected, in this case GPIO 16 (i.e., EQEP A), is set as **input**.

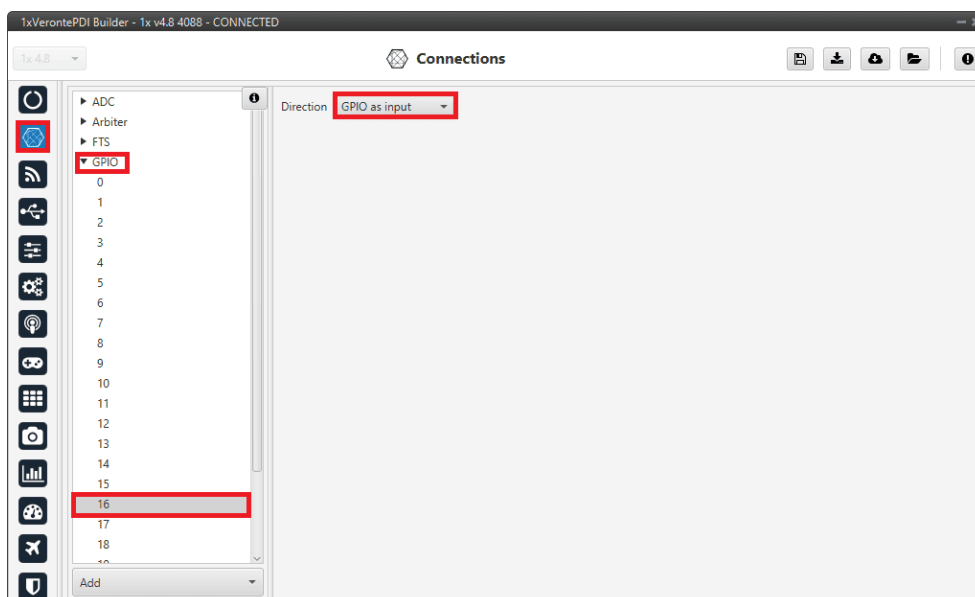

Ground unit - GPIO configuration

3. Go to Stick menu → Transmitter 0 panel → **PPM tab**.
Select the brand of transmitter that applies.

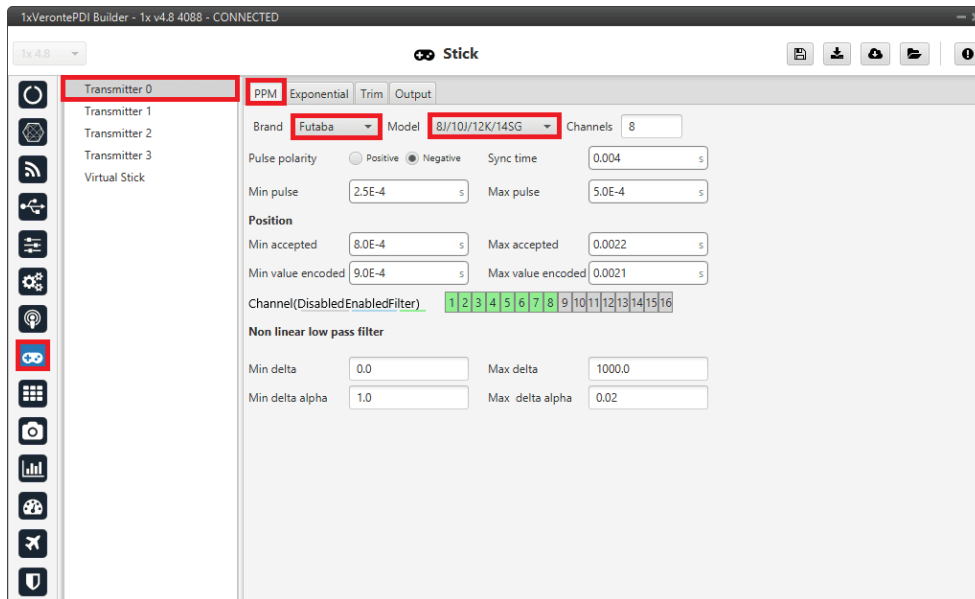

Ground unit - PPM configuration

4. Go to Stick menu → Transmitter 0 panel → **Output tab**.
Click on **Enable** and on **Remote** to send the stick information to the air unit. The recommended values for the configurable parameters have been entered here, as detailed in the [Output - Stick](#) section of the **1x PDI Builder** user manual.

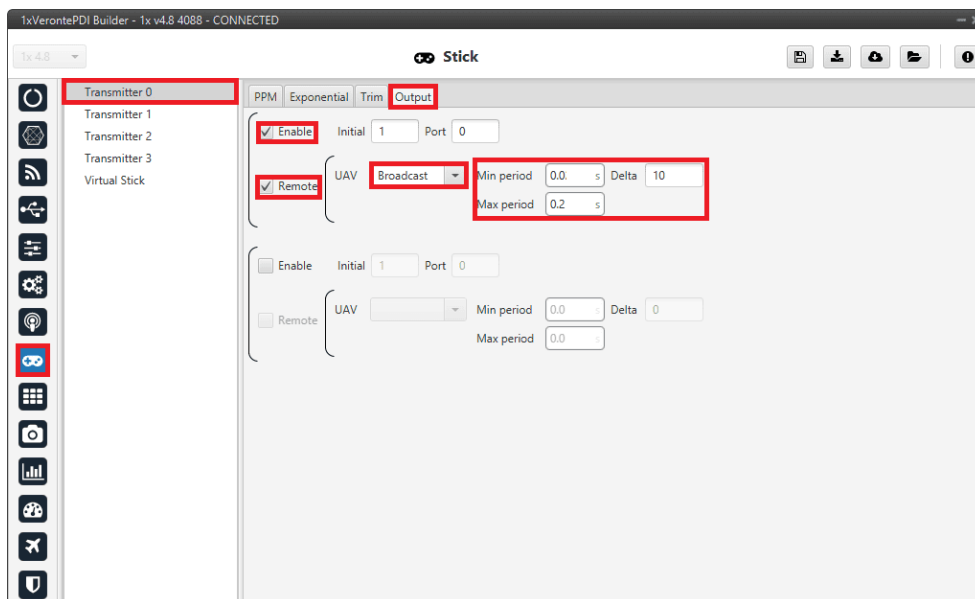

Ground unit - Output configuration

If all these settings are correct, users can check that '**Stick PPM 0 not detected**' variable of the **GND unit** is true.

Stick PPM 0 detected

Stick PPM 0 not detected variable - True

Air unit

1. Go to Stick menu → Transmitter 0 panel → **PPM tab**.
Select the brand of transmitter that applies (make the same configuration as for the ground unit).
2. Go to Stick menu → Transmitter 0 panel → **Output tab**.

Just click on **Enable**.

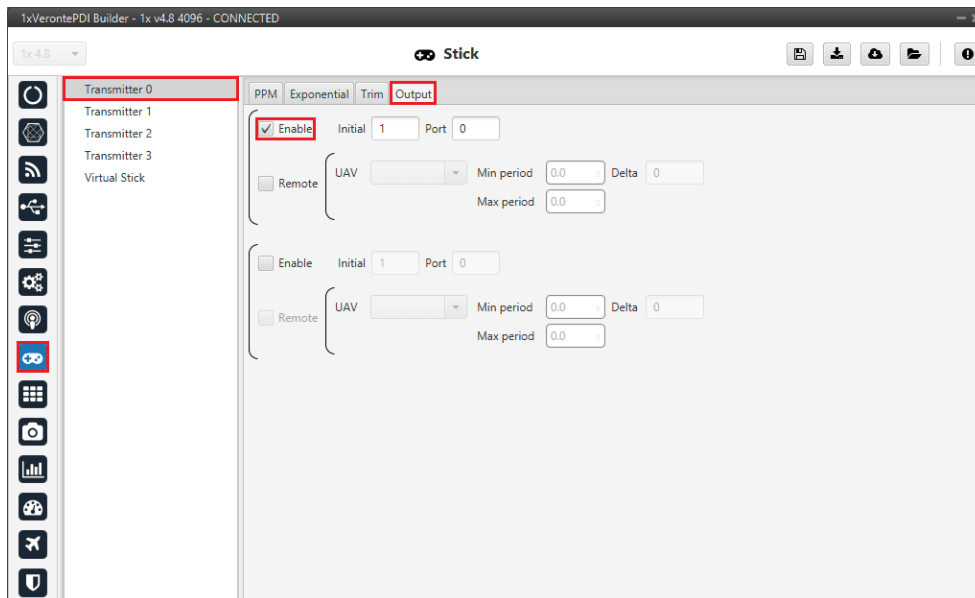

Air unit - Output configuration

3. Go to Block Programs menu → **Stick program** → Double click on the **Stick block** → **Edit sources**.

Note

This is the **Stick program** explained in the **1x Air configuration** section of this manual.

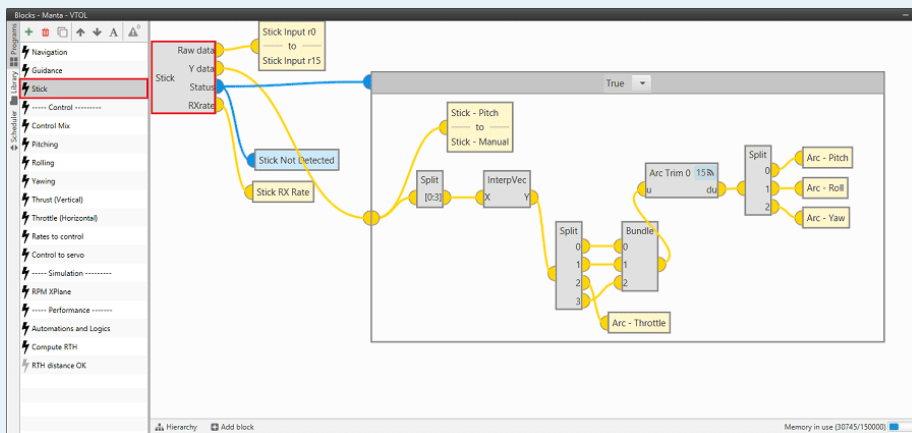

Stick program

Input the **ground unit address** to receive the stick information from that source and put it as the **highest priority** in the priority table. We recommend a Time Out of **0.4 s**.

The 'Stick settings' window shows the 'Sources' tab. The 'Default priority table' has the following data:

Priority	Source	Address	Port	Time Out
1	0	1x v4.8 4088	0	0.4
2	2	Local	0	0.4

The 'Secondary priority table' has the following data:

Priority	Source	Address	Port	Time Out
2	2	Local	0	0.4
1	0	1x v4.8 4088	0	0.4

Air unit - Stick block configuration

Then, if all is correct, users can check that '**Stick not detected**' variable of the **AIR unit** is true.

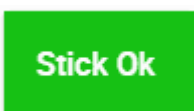

Stick not detected variable - True

And that means that the communication between the GND and the AIR unit is correctly configured.